



OpenNebula 5.7 Deployment guide

Release 5.7.90

OpenNebula Systems

Feb 13, 2019

This document is being provided by OpenNebula Systems under the Creative Commons Attribution-NonCommercial-Share Alike License.

THE DOCUMENT IS PROVIDED "AS IS", WITHOUT WARRANTY OF ANY KIND, EXPRESS OR IMPLIED, INCLUDING BUT NOT LIMITED TO THE WARRANTIES OF MERCHANTABILITY, FITNESS FOR A PARTICULAR PURPOSE AND NONINFRINGEMENT. IN NO EVENT SHALL THE AUTHORS OR COPYRIGHT HOLDERS BE LIABLE FOR ANY CLAIM, DAMAGES OR OTHER LIABILITY, WHETHER IN AN ACTION OF CONTRACT, TORT OR OTHERWISE, ARISING FROM, OUT OF OR IN CONNECTION WITH THE DOCUMENT.

CONTENTS

1	Cloud Design	1
1.1	Overview	1
1.2	Open Cloud Architecture	2
1.3	VMware Cloud Architecture	7
1.4	OpenNebula Provisioning Model	13
2	OpenNebula Installation	19
2.1	Overview	19
2.2	Front-end Installation	19
2.3	MySQL Setup	25
3	Node Installation	27
3.1	Overview	27
3.2	KVM Node Installation	28
3.3	LXD Node Installation	35
3.4	vCenter Node Installation	37
3.5	Verify your Installation	45
4	Authentication Setup	52
4.1	Overview	52
4.2	SSH Authentication	53
4.3	x509 Authentication	55
4.4	LDAP Authentication	58
5	Sunstone Setup	64
5.1	Overview	64
5.2	Sunstone Installation & Configuration	65
5.3	Sunstone Views	72
5.4	Labels	77
5.5	User Security and Authentication	86
5.6	Cloud Servers Authentication	91
5.7	Configuring Sunstone for Large Deployments	94
6	VMware Infrastructure Setup	100
6.1	Overview	100
6.2	vCenter Driver	100
6.3	vCenter Datastores	128
6.4	Datastore clusters with Storage DRS	135
6.5	Marketplace with vCenter Datastores	136
6.6	Tuning and Extending	136
6.7	vCenter Networking Overview	136

6.8	Consuming existing vCenter port groups	137
6.9	Creating Port Groups from OpenNebula	137
6.10	Network monitoring	143
7	Open Cloud Host Setup	144
7.1	Overview	144
7.2	KVM Driver	144
7.3	LXD Driver	155
7.4	Monitoring	160
7.5	PCI Passthrough	164
8	Open Cloud Storage Setup	171
8.1	Overview	171
8.2	Filesystem Datastore	173
8.3	Ceph Datastore	178
8.4	LVM Datastore	183
8.5	Raw Device Mapping (RDM) Datastore	186
8.6	iSCSI - Libvirt Datastore	188
8.7	The Kernels & Files Datastore	190
9	Open Cloud Networking Setup	192
9.1	Overview	192
9.2	Node Setup	193
9.3	Bridged Networking	194
9.4	802.1Q VLAN Networks	196
9.5	VXLAN Networks	197
9.6	Open vSwitch Networks	199
9.7	Open vSwitch on VXLAN Networks	201
10	References	203
10.1	Overview	203
10.2	ONED Configuration	203
10.3	Logging & Debugging	219
10.4	Onedb Tool	222
10.5	Large Deployments	226

CLOUD DESIGN

1.1 Overview

The first step of building a reliable, useful and successful cloud is to decide a clear design. This design needs to be aligned with the expected use of the cloud, and it needs to describe which data center components are going to be part of the cloud. This comprises i) all the infrastructure components such as networking, storage, authorization and virtualization back-ends, as well as the ii) planned dimension of the cloud (characteristics of the workload, numbers of users and so on) and the iii) provisioning workflow, ie, how end users are going to be isolated and using the cloud.

In order to get the most out of a OpenNebula Cloud, we recommend that you create a plan with the features, performance, scalability, and high availability characteristics you want in your deployment. This Chapter provides information to plan an OpenNebula cloud based on *KVM or LXD* or *vCenter*. With this information, you will be able to easily architect and dimension your deployment, as well as understand the technologies involved in the management of virtualized resources and their relationship.

1.1.1 How Should I Read This Chapter

This is the first Chapter to read, as it introduces the needed concepts to correctly define a cloud architecture.

Within this Chapter, as first step a design of the cloud and its dimension should be drafted. For KVM and LXD clouds proceed to *Open Cloud Architecture* and for vCenter clouds read *VMware Cloud Architecture*.

Then you could read the *OpenNebula Provisioning Model* to identify the wanted model to provision resources to end users. In a small installation with a few hosts, you can skip this provisioning model guide and use OpenNebula without giving much thought to infrastructure partitioning and provisioning. But for medium and large deployments you will probably want to provide some level of isolation and structure.

Once the cloud architecture has been designed the next step would be to learn how to install the *OpenNebula front-end*.

1.1.2 Hypervisor Compatibility

Section	Compatibility
<i>Open Cloud Architecture</i>	This Section applies to KVM and LXD.
<i>VMware Cloud Architecture</i>	This Section applies to vCenter.
<i>OpenNebula Provisioning Model</i>	This Section applies to both KVM and vCenter.

1.2 Open Cloud Architecture

Enterprise cloud computing is the next step in the evolution of data center (DC) virtualization. OpenNebula is a simple but feature-rich and flexible solution to build and manage enterprise clouds and virtualized DCs, that combines existing virtualization technologies with advanced features for multi-tenancy, automatic provision and elasticity. OpenNebula follows a bottom-up approach driven by sysadmins, devops and users real needs.

1.2.1 Architectural Overview

OpenNebula assumes that your physical infrastructure adopts a classical cluster-like architecture with a front-end, and a set of hosts where Virtual Machines (VM) will be executed. There is at least one physical network joining all the hosts with the front-end.

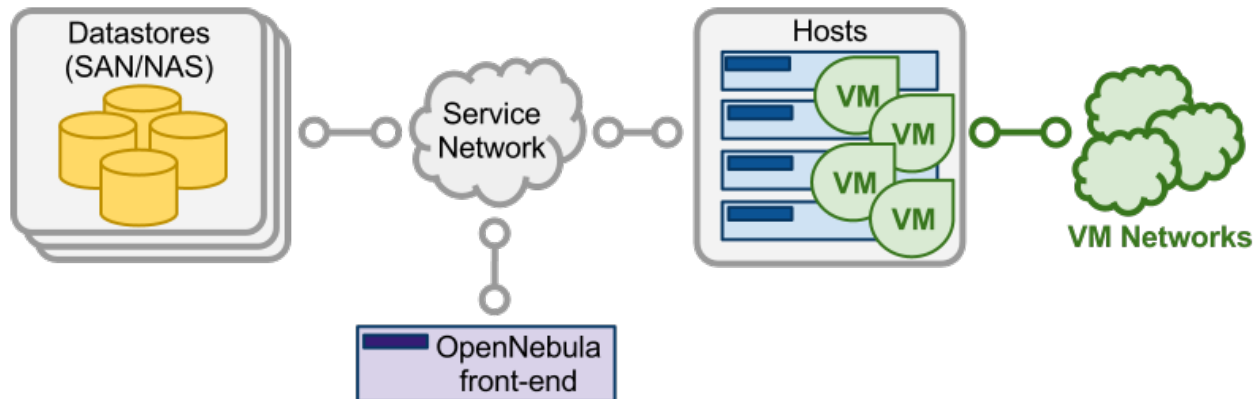

A cloud architecture is defined by three components: storage, networking and virtualization. Therefore, the basic components of an OpenNebula system are:

- **Front-end** that executes the OpenNebula services.
- Hypervisor-enabled **hosts** that provide the resources needed by the VMs.
- **Datastores** that hold the base images of the VMs.
- Physical **networks** used to support basic services such as interconnection of the storage servers and OpenNebula control operations, and VLANs for the VMs.

OpenNebula presents a highly modular architecture that offers broad support for commodity and enterprise-grade hypervisor, monitoring, storage, networking and user management services. This Section briefly describes the different choices that you can make for the management of the different subsystems. If your specific services are not supported we recommend to check the drivers available in the [Add-on Catalog](#). We also provide information and support about how to develop new drivers.

1.2.2 Dimensioning the Cloud

The dimension of a cloud infrastructure can be directly inferred from the expected workload in terms of VMs that the cloud infrastructure must sustain. This workload is also tricky to estimate, but this is a crucial exercise to build an efficient cloud.

The main aspects to take into account at the time of dimensioning the OpenNebula cloud follows.

OpenNebula front-end

The minimum recommended specs are for the OpenNebula front-end are:

Resources	Minimum Recommended configuration
Memory	2 GB
CPU	1 CPU (2 cores)
Disk Size	100 GB
Network	2 NICs

The maximum number of servers (virtualization hosts) that can be managed by a single OpenNebula instance strongly depends on the performance and scalability of the underlying platform infrastructure, mainly the storage subsystem. The general recommendation is that no more than 500 servers managed by a single instance, but there are users with 1,000 servers in each zone. Related to this, read the section about *how to tune OpenNebula for large deployments*.

KVM nodes

Regarding the dimensions of the Linux virtualization nodes:

- **CPU:** without overcommitment, each CPU core assigned to a VM must exist as a physical CPU core. By example, for a workload of 40 VMs with 2 CPUs, the cloud will need 80 physical CPUs. These 80 physical CPUs can be spread among different hosts: 10 servers with 8 cores each, or 5 server of 16 cores each. With overcommitment, however, CPU dimension can be planned ahead, using the CPU and VCPU attributes: CPU states physical CPUs assigned to the VM, while VCPU states virtual CPUs to be presented to the guest OS.
- **MEMORY:** Planning for memory is straightforward, as by default *there is no overcommitment of memory* in OpenNebula. It is always a good practice to count 10% of overhead by the hypervisor (this is not an absolute upper limit, it depends on the hypervisor, however, since containers have a very low overhead, this metric is negligible for LXD nodes). So, in order to sustain a VM workload of 45 VMs with 2GB of RAM each, 90GB of physical memory is needed. The number of hosts is important, as each one will incur a 10% overhead due to the hypervisors. For instance, 10 hypervisors with 10GB RAM each will contribute with 9GB each (10% of 10GB = 1GB), so they will be able to sustain the estimated workload. The rule of thumb is having at least 1GB per core, but this also depends on the expected workload.

LXD nodes Since LXD avoids using virtual hardware, the margining of resources dedicated to the hypervisor are much lower when compared to KVM. There is no exact figure but you can get an idea from [this resource usage comparison vs KVM](#)

Storage

It is important to understand how OpenNebula uses storage, mainly the difference between system and image datastore.

- The **image datastore** is where OpenNebula stores all the images registered that can be used to create VMs, so the rule of thumb is to devote enough space for all the images that OpenNebula will have registered.
- The **system datastore** is where the VMs that are currently running store their disks. It is trickier to estimate correctly since volatile disks come into play with no counterpart in the image datastore (volatile disks are created on the fly in the hypervisor).

One valid approach is to limit the storage available to users by defining quotas in the number of maximum VMs and also the Max Volatile Storage a user can demand, and ensuring enough system and image datastore space to comply with the limit set in the quotas. In any case, OpenNebula allows cloud administrators to add more system and images datastores if needed.

Dimensioning storage is a critical aspect, as it is usually the cloud bottleneck. It very much depends on the underlying technology. As an example, in Ceph for a medium size cloud at least three servers are needed for storage with 5 disks each of 1TB, 16Gb of RAM, 2 CPUs of 4 cores each and at least 2 NICs.

Network

Networking needs to be carefully designed to ensure reliability in the cloud infrastructure. The recommendation is having 2 NICs in the front-end (public and service) (or 3 NICs depending on the storage backend, access to the storage

network may be needed) 4 NICs present in each virtualization node: private, public, service and storage networks. Less NICs can be needed depending on the storage and networking configuration.

1.2.3 Front-End

The machine that holds the OpenNebula installation is called the front-end. This machine needs network connectivity to all the hosts, and possibly access to the storage Datastores (either by direct mount or network). The base installation of OpenNebula takes less than 150MB.

OpenNebula services include:

- Management daemon (`oned`) and scheduler (`mm_sched`)
- Web interface server (`sunstone-server`)
- Advanced components: OneFlow, OneGate, econe, ...

Note: Note that these components communicate through XML-RPC and may be installed in different machines for security or performance reasons

There are several certified platforms to act as front-end for each version of OpenNebula. Refer to the platform notes and chose the one that better fits your needs.

OpenNebula's default database uses **sqlite**. If you are planning a production or medium to large scale deployment, you should consider using *MySQL*.

If you are interested in setting up a high available cluster for OpenNebula, check the High Availability OpenNebula Section.

If you need to federate several datacenters, with a different OpenNebula instance managing the resources but needing a common authentication schema, check the Federation Section.

1.2.4 Monitoring

The monitoring subsystem gathers information relative to the hosts and the virtual machines, such as the host status, basic performance indicators, as well as VM status and capacity consumption. This information is collected by executing a set of static probes provided by OpenNebula. The information is sent according to the following process: each host periodically sends monitoring data to the front-end which collects it and processes it in a dedicated module. This model is highly scalable and its limit (in terms of number of VMs monitored per second) is bounded to the performance of the server running `oned` and the database server.

Please check the *the Monitoring Section* for more details.

1.2.5 Virtualization Hosts

The hosts are the physical machines that will run the VMs. There are several certified platforms to act as nodes for each version of OpenNebula. Refer to the platform notes and chose the one that better fits your needs. The Virtualization Subsystem is the component in charge of talking with the hypervisor installed in the hosts and taking the actions needed for each step in the VM life-cycle.

OpenNebula natively supports two open source hypervisor, the *KVM* and *LXD*.

Ideally, the configuration of the nodes will be homogeneous in terms of the software components installed, the `oneadmin` administration user, accessible storage and network connectivity. This may not always be the case, and homogeneous hosts can be grouped in OpenNebula clusters, ex. LXD cluster and KVM cluster.

If you are interested in fail-over protection against hardware and operating system outages within your virtualized IT environment, check the Virtual Machines High Availability Section.

1.2.6 Storage

OpenNebula uses *Datastores* to store VMs' disk images. A datastore is any storage medium, typically backed by SAN/NAS servers. In general, each datastore has to be accessible through the front-end using any suitable technology NAS, SAN or direct attached storage.

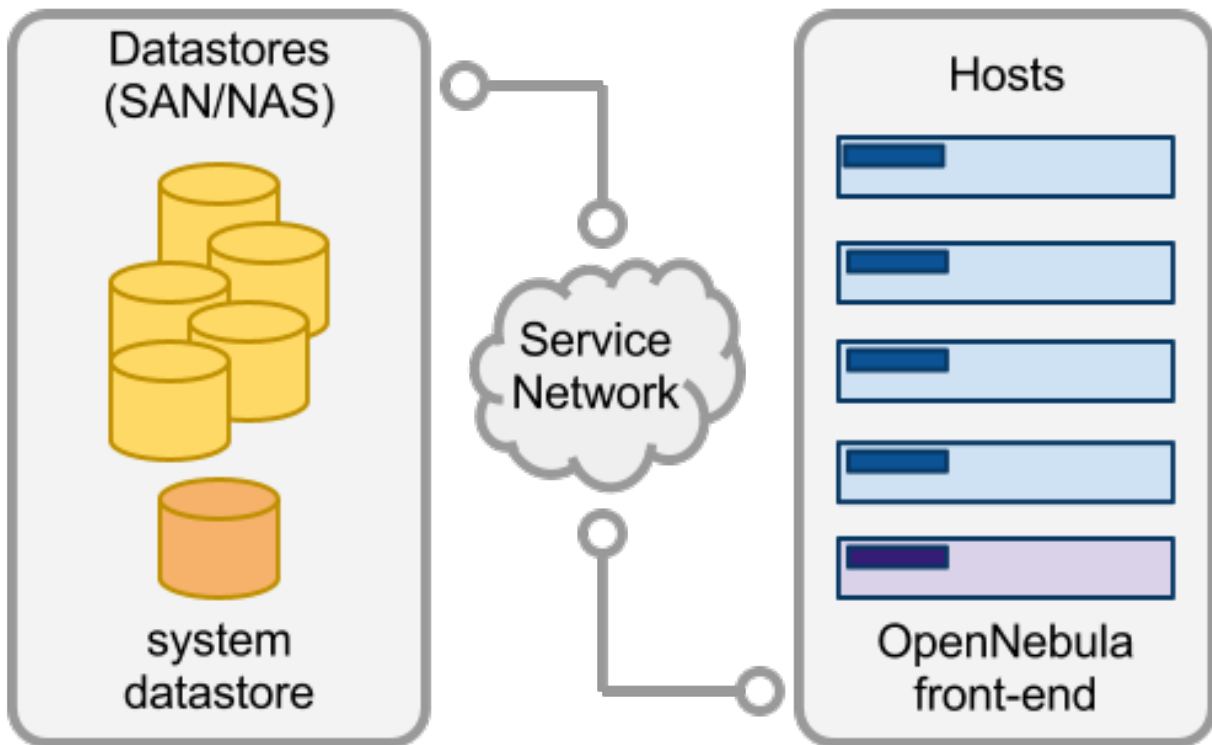

When a VM is deployed, its images are *transferred* from the datastore to the hosts. Depending on the actual storage technology used, it can mean a real transfer, a symbolic link or setting up an LVM volume.

OpenNebula is shipped with 3 different datastore classes:

- **System Datastores:** to hold images for running VMs. Depending on the storage technology used, these temporal images can be complete copies of the original image, qcow deltas or simple filesystem links.
- **Image Datastores:** to store the disk images repository. Disk images are moved, or cloned to/from the System Datastore when the VMs are deployed or shutdown, or when disks are attached or snapshotted.
- **File Datastore:** a special datastore used to store plain files, not disk images. These files can be used as kernels, ramdisks or context files.

Image datastores can be of different types, depending on the underlying storage technology:

- **Filesystem:** to store disk images in a file form. There are three types: ssh, shared and qcow.
- **LVM:** to use LVM volumes instead of plain files to hold the Virtual Images. This reduces the overhead of having a file-system in place and thus increases performance.
- **Ceph:** to store disk images using Ceph block devices.

Warning: Default: The default system and images datastores are configured to use a filesystem with the ssh transfer drivers.

Please check the *Storage Chapter* for more details.

1.2.7 Networking

OpenNebula provides an easily adaptable and customizable network subsystem in order to integrate the specific network requirements of existing datacenters. **At least two different physical networks are needed:**

- **Service Network:** used by the OpenNebula front-end daemons to access the hosts in order to manage and monitor the hypervisors, and move image files. It is highly recommended to install a dedicated network for this purpose;
- **Instance Network:** offers network connectivity to the VMs across the different hosts. To make an effective use of your VM deployments, you will probably need to make one or more physical networks accessible to them.

The OpenNebula administrator may associate one of the following drivers to each Host:

- **dummy** (default): doesn't perform any network operation, and firewalling rules are also ignored.
- **fw:** firewalling rules are applied, but networking isolation is ignored.
- **802.1Q:** restrict network access through VLAN tagging, which requires support by the hardware switches.
- **ebtables:** restrict network access through Ebtables rules. No special hardware configuration required.
- **ovswitch:** restrict network access with [Open vSwitch Virtual Switch](#).
- **vxlan:** segment a VLAN in isolated networks using the VXLAN encapsulation protocol.

Please check the *Networking Chapter* to find out more information about the networking technologies supported by OpenNebula.

1.2.8 Authentication

The following authentication methods are supported to access OpenNebula:

- Built-in User/Password
- *SSH Authentication*
- *X509 Authentication*
- *LDAP Authentication* (and Active Directory)

Warning: Default: OpenNebula comes by default with an internal built-in user/password authentication.

Please check the *Authentication Chapter* to find out more information about the authentication technologies supported by OpenNebula.

1.2.9 Advanced Components

Once you have an OpenNebula cloud up and running, you can install the following advanced components:

- **Multi-VM Applications and Auto-scaling:** OneFlow allows users and administrators to define, execute and manage multi-tiered applications, or services composed of interconnected Virtual Machines with deployment dependencies between them. Each group of Virtual Machines is deployed and managed as a single entity, and is completely integrated with the advanced OpenNebula user and group management.
- **Cloud Bursting:** Cloud bursting is a model in which the local resources of a Private Cloud are combined with resources from remote Cloud providers. Such support for cloud bursting enables highly scalable hosting environments.
- **Public Cloud:** Cloud interfaces can be added to your Private Cloud if you want to provide partners or external users with access to your infrastructure, or to sell your overcapacity. The following interface provide a simple and remote management of cloud (virtual) resources at a high abstraction level: Amazon EC2 and EBS APIs.
- **Application Insight:** OneGate allows Virtual Machine guests to push monitoring information to OpenNebula. Users and administrators can use it to gather metrics, detect problems in their applications, and trigger OneFlow auto-scaling rules.

1.3 VMware Cloud Architecture

OpenNebula is intended for companies willing to create a self-service cloud environment on top of their VMware infrastructure without having to abandon their investment in VMware and retool the entire stack. In these environments, OpenNebula seamlessly integrates with existing vCenter infrastructures to leverage advanced features -such as vMotion, HA or DRS scheduling- provided by the VMware vSphere product family. OpenNebula exposes a multi-tenant, cloud-like provisioning layer on top of vCenter, including features like virtual data centers, data center federation or hybrid cloud computing to connect in-house vCenter infrastructures with public clouds.

OpenNebula over vCenter is intended for companies that want to keep VMware management tools, procedures and workflows. For these companies, throwing away VMware and retooling the entire stack is not the answer. However, as they consider moving beyond virtualization toward a private cloud, they can choose to either invest more in VMware, or proceed on a tactically challenging but strategically rewarding path of open.

1.3.1 Architectural Overview

OpenNebula assumes that your physical infrastructure adopts a classical cluster-like architecture with a front-end, and a set of vCenter instances grouping ESX hosts where Virtual Machines (VM) will be executed. There is at least one physical network joining all the vCenters and ESX hosts with the front-end. Connection from the front-end to vCenter is for management purposes, whereas the connection from the front-end to the ESX hosts is to support the VNC connections.

The VMware vCenter drivers enable OpenNebula to access one or more vCenter servers that manages one or more ESX Clusters. Each ESX Cluster is presented in OpenNebula as an aggregated hypervisor. Note that OpenNebula scheduling decisions are therefore made at ESX Cluster level, vCenter then uses the DRS component to select the actual ESX host and Datastore to deploy the Virtual Machine.

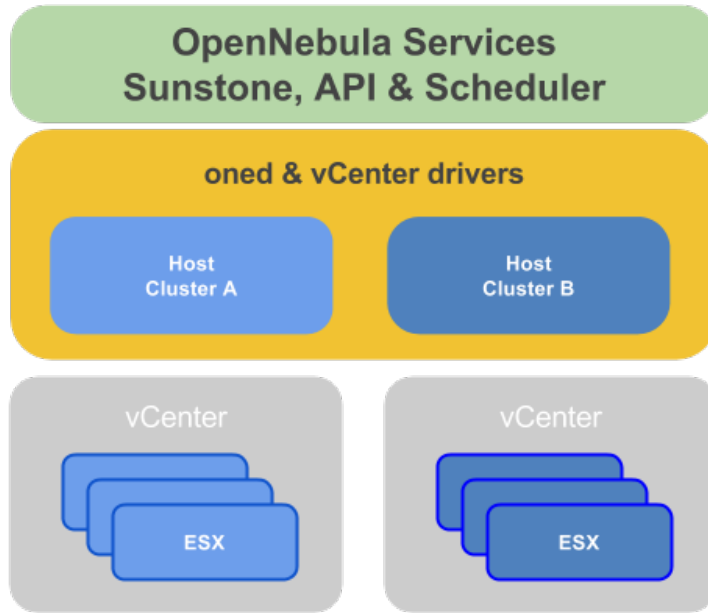

A cloud architecture is defined by three components: storage, networking and virtualization. Therefore, the basic components of an OpenNebula cloud are:

- **Front-end** that executes the OpenNebula services.
- Hypervisor-enabled **hosts** that provide the resources needed by the VMs.
- **Datastores** that hold the base images of the VMs.
- Physical **networks** used to support basic services such as interconnection of the VMs.

OpenNebula presents a highly modular architecture that offers broad support for commodity and enterprise-grade hypervisor, monitoring, storage, networking and user management services. This Section briefly describes the different choices that you can make for the management of the different subsystems. If your specific services are not supported we recommend to check the drivers available in the [Add-on Catalog](#). We also provide information and support about how to develop new drivers.

1.3.2 Dimensioning the Cloud

The dimension of a cloud infrastructure can be directly inferred from the expected workload in terms of VMs that the cloud infrastructure must sustain. This workload is also tricky to estimate, but this is a crucial exercise to build an efficient cloud.

OpenNebula front-end

The minimum recommended specs are for the OpenNebula front-end are:

Resource	Minimum Recommended configuration
Memory	2 GB
CPU	1 CPU (2 cores)
Disk Size	100 GB
Network	2 NICS

When running on a front-end with the minimums described in the above table, OpenNebula is able to manage a vCenter infrastructure of the following characteristics:

- Up to 4 vCenters
- Up to 40 ESXs managed by each vCenter
- Up to 1.000 VMs in total, each vCenter managing up to 250 VMs

ESX nodes

Regarding the dimensions of the ESX virtualization nodes:

- **CPU:** without overcommitment, each CPU core assigned to a VM must exist as a physical CPU core. By example, for a workload of 40 VMs with 2 CPUs, the cloud will need 80 physical CPUs. These 80 physical CPUs can be spread among different hosts: 10 servers with 8 cores each, or 5 server of 16 cores each. With overcommitment, however, CPU dimension can be planned ahead, using the `CPU` and `VCPU` attributes: `CPU` states physical CPUs assigned to the VM, while `VCPU` states virtual CPUs to be presented to the guest OS.
- **MEMORY:** Planning for memory is straightforward, as by default *there is no overcommitment of memory* in OpenNebula. It is always a good practice to count 10% of overhead by the hypervisor (this is not an absolute upper limit, it depends on the hypervisor). So, in order to sustain a VM workload of 45 VMs with 2GB of RAM each, 90GB of physical memory is needed. The number of hosts is important, as each one will incur a 10% overhead due to the hypervisors. For instance, 10 hypervisors with 10GB RAM each will contribute with 9GB each (10% of 10GB = 1GB), so they will be able to sustain the estimated workload. The rule of thumb is having at least 1GB per core, but this also depends on the expected workload.

Storage

Dimensioning storage is a critical aspect, as it is usually the cloud bottleneck. OpenNebula can manage any datastore that is mounted in the ESX and visible in vCenter. The datastore used by a VM can be fixed by the cloud admin or delegated to the cloud user. It is important to ensure that enough space is available for new VMs, otherwise its creation process will fail. One valid approach is to limit the storage available to users by defining quotas in the number of maximum VMs, and ensuring enough datastore space to comply with the limit set in the quotas. In any case, OpenNebula allows cloud administrators to add more datastores if needed.

Network

Networking needs to be carefully designed to ensure reliability in the cloud infrastructure. The recommendation is having 2 NICs in the front-end (service and public network) 4 NICs present in each ESX node: private, public, service and storage networks. Less NICs can be needed depending on the storage and networking configuration.

1.3.3 Front-End

The machine that holds the OpenNebula installation is called the front-end. This machine needs network connectivity to all the vCenter and ESX hosts. The base installation of OpenNebula takes less than 150MB.

OpenNebula services include:

- Management daemon (`oned`) and scheduler (`mm_sched`)
- Web interface server (`sunstone-server`)

- Advanced components: OneFlow, OneGate, econe, ...

Note: Note that these components communicate through XML-RPC and may be installed in different machines for security or performance reasons

There are several certified platforms to act as front-end for each version of OpenNebula. Refer to the platform notes and chose the one that better fits your needs.

OpenNebula's default database uses **sqlite**. If you are planning a production or medium to large scale deployment, you should consider using *MySQL*.

If you are interested in setting up a high available cluster for OpenNebula, check the High Availability OpenNebula Section.

1.3.4 Monitoring

The monitoring subsystem gathers information relative to the hosts and the virtual machines, such as the host status, basic performance indicators, as well as VM status and capacity consumption. This information is collected by executing a set of probes in the front-end provided by OpenNebula.

Please check the *the Monitoring Section* for more details.

1.3.5 Virtualization Hosts

The VMware vCenter drivers enable OpenNebula to access one or more vCenter servers that manages one or more ESX Clusters. Each ESX Cluster is presented in OpenNebula as an aggregated hypervisor. The Virtualization Subsystem is the component in charge of talking with vCenter and taking the actions needed for each step in the VM life-cycle. All the management operations are issued by the front-end to vCenter, except the VNC connection that is performed directly from the front-end to the ESX where a particular VM is running.

OpenNebula natively supports *vCenter* hypervisor, vCenter drivers need to be configured in the OpenNebula front-end.

If you are interested in fail-over protection against hardware and operating system outages within your virtualized IT environment, check the Virtual Machines High Availability Section.

1.3.6 Storage

OpenNebula interacts as a consumer of vCenter storage, and as such, supports all the storage devices supported by *ESX*. When a VM is instantiated from a VM Template, OpenNebula's Scheduler will choose a datastore using the default policy of distributing the VMs between across available datastores, however this scheduler policy can be changed and you can force VMs instantiated from a template to use a specific datastore thanks to the `SCHED_DS_REQUIREMENTS` attribute. If Storage DRS is enabled, OpenNebula can request storage recommendations to the Storage DRS cluster and apply them when a VM is instantiated, so in this case OpenNebula would delegate the datastore selection to vCenter's Storage DRS.

vCenter/ESX Datastores can be represented in OpenNebula to create, clone and/or upload VMDKs. The vCenter/ESX datastore representation in OpenNebula is described in the *vCenter datastore Section*.

1.3.7 Networking

Networking in OpenNebula is handled by creating or importing Virtual Network representations of vCenter Networks and Distributed vSwitches. In this way, new VMs with defined network interfaces will be bound by OpenNebula to

these Networks and/or Distributed vSwitches. OpenNebula can create a new logical layer of these vCenter Networks and Distributed vSwitches, in particular three types of Address Ranges can be defined per Virtual Network representing the vCenter network resources: plain Ethernet, IPv4 and IPv6. This networking information can be passed to the VMs through the contextualization process.

Please check the *Networking Chapter* to find out more information about the networking support in vCenter infrastructures by OpenNebula.

1.3.8 Authentication

The following authentication methods are supported to access OpenNebula:

- Built-in User/Password
- *SSH Authentication*
- *X509 Authentication*
- *LDAP Authentication* (and Active Directory)

Warning: Default: OpenNebula comes by default with an internal built-in user/password authentication.
--

Please check the *Authentication Chapter* to find out more information about the authentication technologies supported by OpenNebula.

1.3.9 Multi-Datacenter Deployments

OpenNebula interacts with the vCenter instances by interfacing with its SOAP API exclusively. This characteristic enables architectures where the OpenNebula instance and the vCenter environment are located in different datacenters. A single OpenNebula instances can orchestrate several vCenter instances remotely located in different data centers. Connectivity between data centers needs to have low latency in order to have a reliable management of vCenter from OpenNebula.

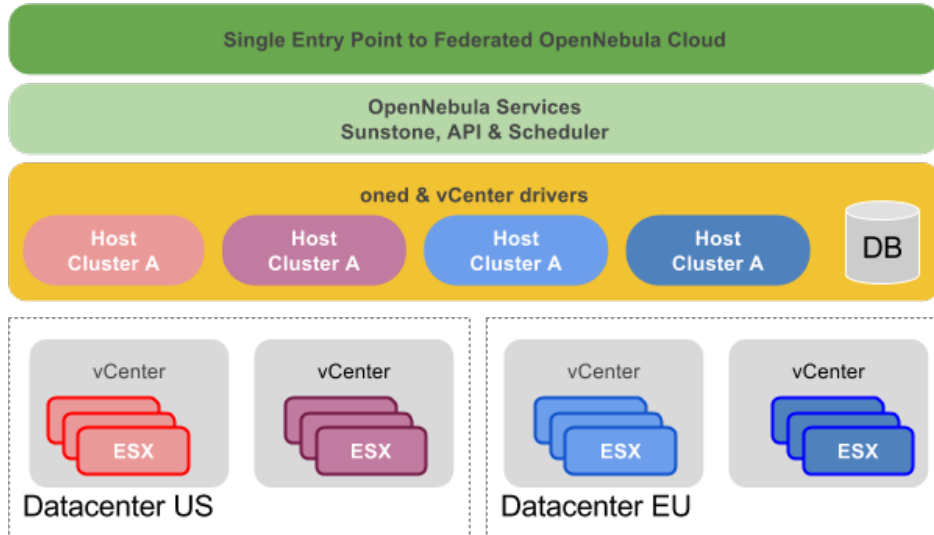

When administration domains need to be isolated or the interconnection between datacenters does not allow a single controlling entity, OpenNebula can be configured in a federation. Each OpenNebula instance of the federation is called a Zone, one of them configured as master and the others as slaves. An OpenNebula federation is a tightly coupled integration, all the instances will share the same user accounts, groups, and permissions configuration. Federation allows end users to consume resources allocated by the federation administrators regardless of their geographic location. The integration is seamless, meaning that a user logged into the Sunstone web interface of a Zone will not have to log out and enter the address of another Zone. Sunstone allows to change the active Zone at any time, and it will automatically redirect the requests to the right OpenNebula at the target Zone. For more information, check the Federation Section.

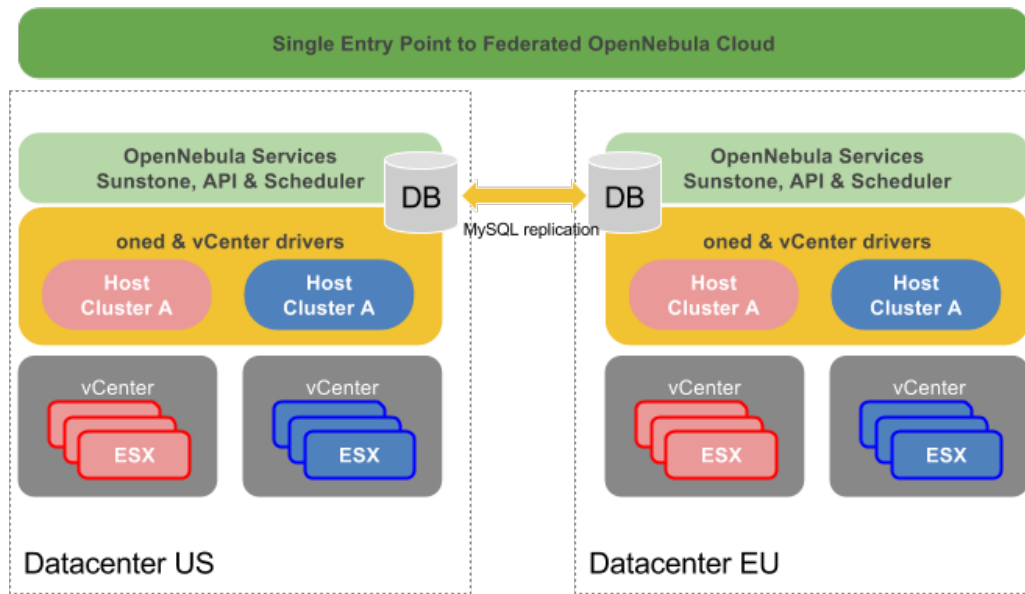

1.3.10 Advanced Components

Once you have an OpenNebula cloud up and running, you can install the following advanced components:

- **Multi-VM Applications and Auto-scaling:** OneFlow allows users and administrators to define, execute and manage services composed of interconnected Virtual Machines with deployment dependencies between them. Each group of Virtual Machines is deployed and managed as a single entity, and is completely integrated with the advanced OpenNebula user and group management.
- **Cloud Bursting:** Cloud bursting is a model in which the local resources of a Private Cloud are combined with resources from remote Cloud providers. Such support for cloud bursting enables highly scalable hosting environments.
- **Public Cloud:** Cloud interfaces can be added to your Private Cloud if you want to provide partners or external users with access to your infrastructure, or to sell your overcapacity. The following interface provide a simple and remote management of cloud (virtual) resources at a high abstraction level: Amazon EC2 and EBS APIs.
- **Application Insight:** OneGate allows Virtual Machine guests to push monitoring information to OpenNebula. Users and administrators can use it to gather metrics, detect problems in their applications, and trigger OneFlow auto-scaling rules.

1.4 OpenNebula Provisioning Model

In a small installation with a few hosts, you can use OpenNebula without giving much thought to infrastructure partitioning and provisioning. But for medium and large deployments you will probably want to provide some level of isolation and structure.

This Section is meant for cloud architects, builders and administrators, to help them understand the OpenNebula model for managing and provisioning virtual resources. This model is a result of our collaboration with our user community throughout the life of the project.

1.4.1 The Infrastructure Perspective

Common large IT shops have multiple Data Centers (DCs), each one running its own OpenNebula instance and consisting of several physical Clusters of infrastructure resources (Hosts, Networks and Datastores). These Clusters could present different architectures and software/hardware execution environments to fulfill the needs of different workload profiles. Moreover, many organizations have access to external public clouds to build hybrid cloud scenarios where the private capacity of the Data Centers is supplemented with resources from external clouds, like Amazon AWS, to address peaks of demand.

For example, you could have two Data Centers in different geographic locations, Europe and USA West Coast, and an agreement for cloudbursting with a public cloud provider, such as Amazon, and/or Azure. Each Data Center runs its own zone or full OpenNebula deployment. Multiple OpenNebula Zones can be configured as a federation, and in this case they will share the same user accounts, groups, and permissions across Data Centers.

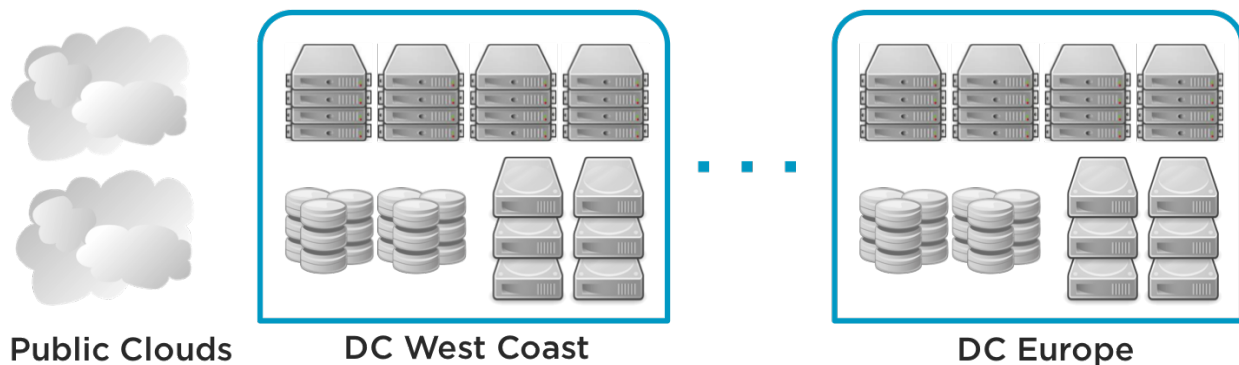

1.4.2 The Organizational Perspective

Users are organized into Groups (similar to what other environments call Projects, Domains, Tenants...). A Group is an authorization boundary that can be seen as a business unit if you are considering it as a private cloud or as a complete new company if it is a public cloud. While Clusters are used to group Physical Resources according to common characteristics such as networking topology or physical location, Virtual Data Centers (VDCs) allow to create “logical” pools of Physical Resources (which could belong to different Clusters and Zones) and allocate them to user Groups.

A VDC is a fully-isolated virtual infrastructure environment where a Group of users (or optionally several Groups of users), under the control of a Group admin, can create and manage compute and storage capacity. The users in the Group, including the Group admin, would only see the virtual resources and not the underlying physical infrastructure. The Physical Resources allocated to the Group are managed by the cloud administrator through a VDC. These resources grouped in the VDC can be dedicated exclusively to the Group, providing isolation at the physical level too.

The privileges of the Group users and the admin regarding the operations over the virtual resources created by other users can be configured. For example, in the Advanced Cloud Provisioning Case described below, the users can instantiate virtual machine templates to create their machines, while the admins of the Group have full control over other users’ resources and can also create new users in the Group.

Users can access their resources through any of the existing OpenNebula interfaces, such as the CLI, Sunstone Cloud View, OCA, or the AWS APIs. Group admins can manage their Groups through the CLI or the Group Admin View in Sunstone. Cloud administrators can manage the Groups through the CLI or Sunstone.

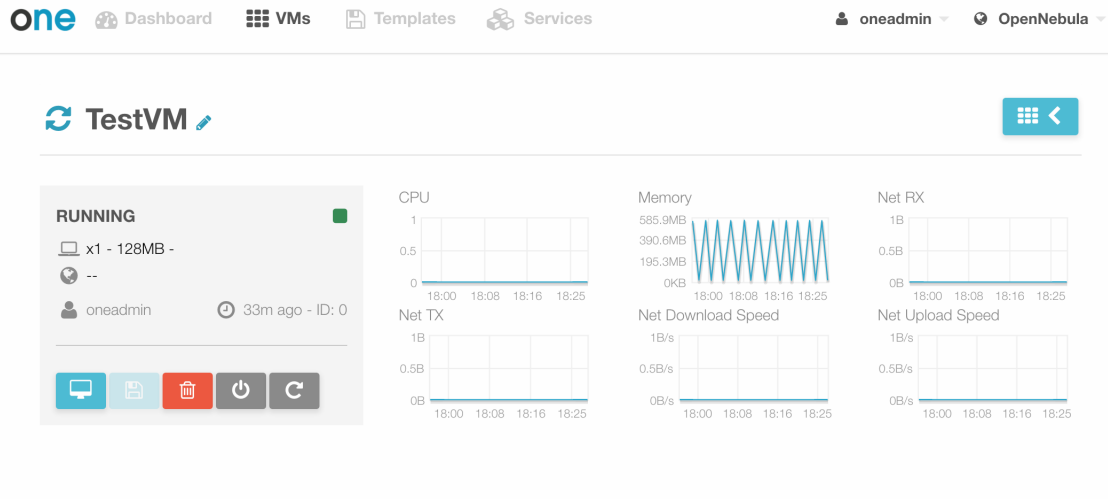

The Cloud provisioning model based on VDCs enables an integrated, comprehensive framework to dynamically provision the infrastructure resources in large multi-datacenter environments to different customers, business units or groups. This brings several benefits:

- Partitioning of cloud Physical Resources between Groups of users
- Complete isolation of Users, organizations or workloads
- Allocation of Clusters with different levels of security, performance or high availability
- Containers for the execution of software-defined data centers
- Way of hiding Physical Resources from Group members
- Simple federation, scalability and cloudbursting of private cloud infrastructures beyond a single cloud instance and data center

1.4.3 Examples of Provisioning Use Cases

The following are common enterprise use cases in large cloud computing deployments:

- **On-premise Private Clouds** Serving Multiple Projects, Departments, Units or Organizations. On-premise private clouds in large organizations require powerful and flexible mechanisms to manage the access privileges to the virtual and physical infrastructure and to dynamically allocate the available resources. In these scenarios, the Cloud Administrator would define a VDC for each Department, dynamically allocating resources according to their needs, and delegating the internal administration of the Group to the Department IT Administrator.
- **Cloud Providers** Offering Virtual Private Cloud Computing. Cloud providers providing customers with a fully-configurable and isolated environment where they have full control and capacity to administer its users and resources. This combines a public cloud with the control usually seen in a personal private cloud system.

For example, you can think Web Development, Human Resources, and Big Data Analysis as business units represented by Groups in a private OpenNebula cloud, and allocate them resources from your DCs and public clouds in order to create three different VDCs.

- **VDC BLUE:** VDC that allocates (ClusterA-DC_West_Coast + Cloudbursting) to Web Development
- **VDC RED:** VDC that allocates (ClusterB-DC_West_Coast + ClusterA-DC_Europe + Cloudbursting) to Human Resources
- **VDC GREEN:** VDC that allocates (ClusterC-DC_West_Coast + ClusterB-DC_Europe) to Big Data Analysis

Web Development



Human Resources



Big Data Analysis



Public Clouds

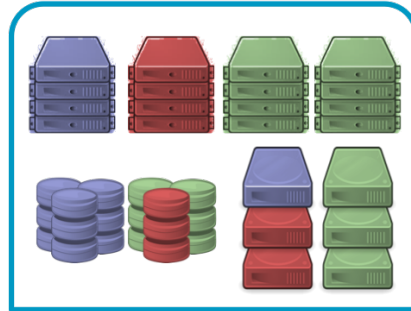

DC West Coast

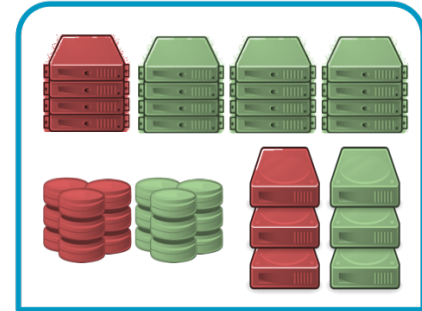

DC Europe

1.4.4 Cloud Provisioning Scenarios

OpenNebula has three predefined User roles to implement three typical enterprise cloud scenarios:

- Data center infrastructure management
- Simple cloud provisioning model
- Advanced cloud provisioning model

In these three scenarios, Cloud Administrators manage the physical infrastructure, creates Users and VDCs, prepares base templates and images for Users, etc

Cloud Administrators typically access the cloud using the CLI or the Admin View of Sunstone.

Role	Capabilities
Cloud Admin.	<ul style="list-style-type: none"> • Operates the Cloud infrastructure (i.e. computing nodes, networking fabric, storage servers) • Creates and manages OpenNebula infrastructure resources: Hosts, Virtual Networks, Datastores • Creates and manages Multi-VM Applications (Services) • Creates new Groups and VDCs • Assigns Groups and physical resources to a VDC and sets quota limits • Defines base instance types to be used by the users. These types define the capacity of the VMs (memory, cpu and additional storage) and connectivity. • Prepare VM images to be used by the users • Monitor the status and health of the cloud • Generate activity reports

Data Center Infrastructure Management

This model is used to manage data center virtualization and to integrate and federate existing IT assets that can be in different data centers. In this usage model, Users are familiar with virtualization concepts. Except for the infrastructure resources, the web interface offers the same operations available to the Cloud Admin. These are “Advanced Users” that could be considered also as “Limited Cloud Administrators”.

Users can use the templates and images pre-defined by the cloud administrator, but usually are also allowed to create their own templates and images. They are also able to manage the life-cycle of their resources, including advanced features that may harm the VM guests, like hot-plugging of new disks, resize of Virtual Machines, modify boot parameters, etc.

Groups are used by the Cloud Administrator to isolate users, which are combined with VDCs to have allocated resources, but are not offered on-demand.

These “Advanced Users” typically access the cloud by using the CLI or the User View of Sunstone. This is not the default model configured for the group Users.

Role	Capabilities
Advanced User	<ul style="list-style-type: none"> • Instantiates VMs using their own templates • Creates new templates and images • Manages their VMs, including advanced life-cycle features • Creates and manages Multi-VM Application (Services) • Check their usage and quotas • Upload SSH keys to access the VMs

Simple Cloud Provisioning

In the simple infrastructure provisioning model, the Cloud offers infrastructure as a service to individual Users. Users are considered as “Cloud Users” or “Cloud Consumers”, being much more limited in their operations. These Users access a very intuitive simplified web interface that allows them to launch Virtual Machines from predefined Templates. They can access their VMs, and perform basic operations like shutdown. The changes made to a VM disk can be saved back, but new Images cannot be created from scratch.

Groups are used by the Cloud Administrator to isolate users, which are combined with VDCs to have allocated resources, but are not offered on-demand.

These “Cloud Users” typically access the cloud by using the Cloud View of Sunstone. This is the default model configured for the group Users.

Role	Capabilities
Cloud User	<ul style="list-style-type: none"> • Instantiates VMs using the templates defined by the Cloud Admins and the images defined by the Cloud Admins or Group Admins. • Instantiates VMs using their own Images saved from a previous running VM • Manages their VMs, including <ul style="list-style-type: none"> – reboot – power off/on (short-term switching-off) – delete – save a VM into a new Template – obtain basic monitor information and status (including IP addresses) • Delete any previous VM template and disk snapshot • Check user account usage and quotas • Upload SSH keys to access the VMs

Advanced Cloud Provisioning

The advanced provisioning model is an extension of the previous one where the cloud provider offers VDCs on demand to Groups of Users (projects, companies, departments or business units). Each Group can define one or more users as Group Admins. These admins can create new users inside the Group, and also manage the resources of the rest of the users. A Group Admin may, for example, shutdown a VM from other user to free group quota usage.

These Group Admins typically access the cloud by using the Group Admin View of Sunstone.

The Group Users have the capabilities described in the previous scenario and typically access the cloud by using the Cloud View of Sunstone.

Role	Capabilities
Group Admin.	<ul style="list-style-type: none"> • Creates new users in the Group • Operates on the Group’s virtual machines and disk images • Share Saved Templates with the members of the Group • Checks Group usage and quotas

OPENNEBULA INSTALLATION

2.1 Overview

The Front-end is the central part of an OpenNebula installation. This is the machine where the server software is installed and where you connect to manage your cloud. It can be a physical node or a virtual instance.

2.1.1 How Should I Read This Chapter

Before reading this chapter make sure you have read and understood the *Cloud Design* chapter.

The aim of this chapter is to give you a quick-start guide to deploy OpenNebula. This is the simplest possible installation, but it is also the foundation for a more complex setup, with Advanced Components (like Host and VM High Availability, Cloud Bursting, etc. . .).

First you should read the *Front-end Installation* section. Note that by default it uses a SQLite database that is not recommended for production so, if this is not a small proof of concept, while following the Installation section, you should enable *MySQL*.

After reading this chapter, read the *Node Installation* chapter next in order to add hypervisors to your cloud.

2.1.2 Hypervisor Compatibility

Section	Compatibility
<i>Front-end Installation</i>	This Section applies to all hypervisors
<i>MySQL Setup</i>	This Section applies to all hypervisors
Scheduler	This Section applies to all hypervisors

2.2 Front-end Installation

This page shows you how to install OpenNebula from the binary packages.

Using the packages provided in our site is the recommended method, to ensure the installation of the latest version and to avoid possible packages divergences of different distributions. There are two alternatives here: you can add **our package repositories** to your system, or visit the [software menu](#) to **download the latest package** for your Linux distribution.

If there are no packages for your distribution, head to the Building from Source Code guide.

2.2.1 Step 1. SELinux on CentOS/RHEL 7

SELinux can block some operations initiated by the OpenNebula Front-end, which results in their failures. If the administrator isn't experienced in the SELinux configuration, **it's recommended to disable this functionality to avoid unexpected failures**. You can enable SELinux anytime later when you have the installation working.

Disable SELinux (recommended)

Change the following line in `/etc/selinux/config` to **disable** SELinux:

```
SELINUX=disabled
```

After the change, you have to reboot the machine.

Enable SELinux

Change the following line in `/etc/selinux/config` to **enable** SELinux in enforcing state:

```
SELINUX=enforcing
```

When changing from the `disabled` state, it's necessary to trigger filesystem relabel on the next boot by creating a file `/.autorelabel`, e.g.:

```
$ touch /.autorelabel
```

After the changes, you should reboot the machine.

Note: Follow the [SELinux User's and Administrator's Guide](#) for more information on how to configure and troubleshoot the SELinux.

2.2.2 Step 2. Add OpenNebula Repositories

CentOS/RHEL 7

To add OpenNebula repository execute the following as root:

```
# cat << EOT > /etc/yum.repos.d/opennebula.repo
[opennebula]
name=opennebula
baseurl=https://downloads.opennebula.org/repo/5.7/CentOS/7/x86_64
enabled=1
gpgkey=https://downloads.opennebula.org/repo/repo.key
gpgcheck=1
#repo_gpgcheck=1
EOT
```

Debian/Ubuntu

To add OpenNebula repository on Debian/Ubuntu execute as root:

```
# wget -q -O- https://downloads.opennebula.org/repo/repo.key | apt-key add -
```

Debian 9

```
# echo "deb https://downloads.opennebula.org/repo/5.7/Debian/9 stable opennebula" > /etc/apt/sources
```

Ubuntu 14.04

```
# echo "deb https://downloads.opennebula.org/repo/5.7/Ubuntu/14.04 stable opennebula" > /etc/apt/sour
```

Ubuntu 16.04

```
# echo "deb https://downloads.opennebula.org/repo/5.7/Ubuntu/16.04 stable opennebula" > /etc/apt/sour
```

Ubuntu 18.04

```
# echo "deb https://downloads.opennebula.org/repo/5.7/Ubuntu/18.04 stable opennebula" > /etc/apt/sour
```

2.2.3 Step 3. Installing the Software

Installing on CentOS/RHEL 7

Note: Activate the [EPEL](#) (Extra Packages for Enterprise Linux) repository before installing the OpenNebula.

On CentOS 7, enabling EPEL is as easy as installation of the package with additional repository configuration:

```
# yum install epel-release
```

On RHEL 7, first you need the RHEL **optional** and **extras** repositories configured:

```
# subscription-manager repos --enable rhel-7-server-optional-rpms
# subscription-manager repos --enable rhel-7-server-extras-rpms
```

and, then you can enable the EPEL:

```
# rpm -ivh https://dl.fedoraproject.org/pub/epel/epel-release-latest-7.noarch.rpm
```

Install the CentOS/RHEL OpenNebula Front-end with packages from **our repository** by executing the following as root:

```
# yum install opennebula-server opennebula-sunstone opennebula-ruby opennebula-gate_
↪opennebula-flow
```

CentOS/RHEL Package Description

The packages for the OpenNebula front-end and the virtualization host are as follows:

- **opennebula:** Command Line Interface.
- **opennebula-server:** Main OpenNebula daemon, scheduler, etc.
- **opennebula-sunstone:** *Sunstone* (the GUI) and the EC2 API.
- **opennebula-ruby:** Ruby Bindings.
- **opennebula-java:** Java Bindings.
- **python-opennebula:** Python Bindings.
- **opennebula-gate:** OneGate server that enables communication between VMs and OpenNebula.
- **opennebula-flow:** OneFlow manages services and elasticity.
- **opennebula-node-kvm:** Meta-package that installs the oneadmin user, libvirt and kvm.

- **opennebula-common**: Common files for OpenNebula packages.

Note: The configuration files are located in `/etc/one` and `/var/lib/one/remotes/etc`.

Installing on Debian/Ubuntu

To install OpenNebula on a Debian/Ubuntu Front-end using packages from **our repositories** execute as root:

```
# apt-get update
# apt-get install opennebula opennebula-sunstone opennebula-gate opennebula-flow
```

Debian/Ubuntu Package Description

These are the packages available for these distributions:

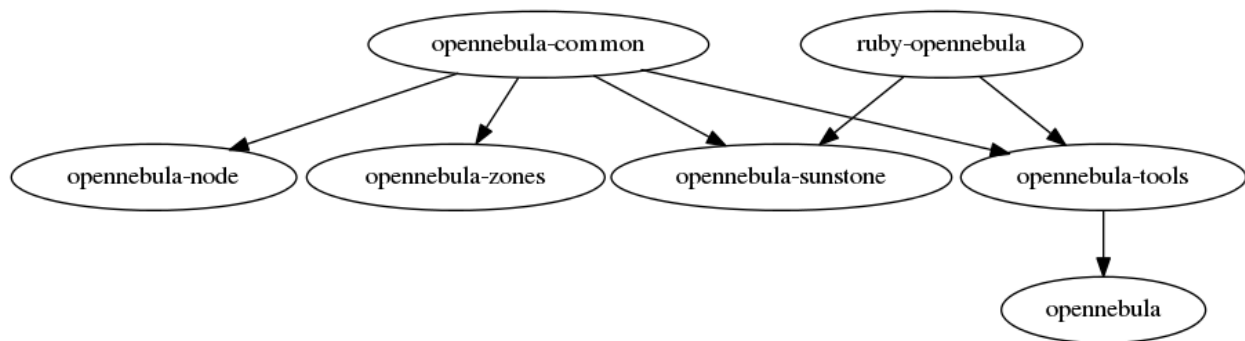

- **opennebula-common**: Provides the user and common files.
- **ruby-opennebula**: Ruby API.
- **libopennebula-java**: Java API.
- **python-opennebula**: Python API.
- **libopennebula-java-doc**: Java API Documentation.
- **opennebula-node**: Prepares a node as an opennebula KVM node.
- **opennebula-node-lxd**: Prepares a node as an opennebula LXD node.
- **opennebula-sunstone**: *Sunstone* (the GUI).
- **opennebula-tools**: Command Line interface.
- **opennebula-gate**: OneGate server that enables communication between VMs and OpenNebula.
- **opennebula-flow**: OneFlow manages services and elasticity.
- **opennebula**: OpenNebula Daemon.

Note: Besides `/etc/one`, the following files are marked as configuration files:

- `/var/lib/one/remotes/etc/datastore/ceph/ceph.conf`
 - `/var/lib/one/remotes/etc/vnm/OpenNebulaNetwork.conf`
-

2.2.4 Step 4. Ruby Runtime Installation

Some OpenNebula components need Ruby libraries. OpenNebula provides a script that installs the required gems as well as some development libraries packages needed.

As root execute:

```
# /usr/share/one/install_gems
```

The previous script is prepared to detect common Linux distributions and install the required libraries. If it fails to find the packages needed in your system, manually install these packages:

- sqlite3 development library
- mysql client development library
- curl development library
- libxml2 and libxslt development libraries
- ruby development library
- gcc and g++
- make

If you want to install only a set of gems for an specific component read Building from Source Code where it is explained in more depth.

2.2.5 Step 5. Enabling MySQL/MariaDB (Optional)

You can skip this step if you just want to deploy OpenNebula as quickly as possible. However if you are deploying this for production or in a more serious environment, make sure you read the *MySQL Setup* section.

Note that it **is** possible to switch from SQLite to MySQL, but since it's more cumbersome to migrate databases, we suggest that if in doubt, use MySQL from the start.

2.2.6 Step 6. Starting OpenNebula

Warning: If you are performing an upgrade skip this and the next steps and go back to the upgrade document.

Log in as the `oneadmin` user follow these steps:

The `/var/lib/one/.one/one_auth` file will have been created with a randomly-generated password. It should contain the following: `oneadmin:<password>`. Feel free to change the password before starting OpenNebula. For example:

```
$ echo "oneadmin:mypassword" > ~/.one/one_auth
```

Warning: This will set the `oneadmin` password on the first boot. From that point, you must use the `oneuser passwd` command to change `oneadmin`'s password. More information on how to change `oneadmin` password here

You are ready to start the OpenNebula daemons. You can use `systemctl` for Linux distributions which have adopted `systemd`:

```
# systemctl start opennebula
# systemctl start opennebula-sunstone
```

Or use service in older Linux systems:

```
# service opennebula start
# service opennebula-sunstone start
```

2.2.7 Step 7. Verifying the Installation

After OpenNebula is started for the first time, you should check that the commands can connect to the OpenNebula daemon. You can do this in the Linux CLI or in the graphical user interface: Sunstone.

Linux CLI

In the Front-end, run the following command as oneadmin:

```
$ oneuser show
USER 0 INFORMATION
ID           : 0
NAME        : oneadmin
GROUP       : oneadmin
PASSWORD    : 3bc15c8aae3e4124dd409035f32ea2fd6835efc9
AUTH_DRIVER : core
ENABLED     : Yes

USER TEMPLATE
TOKEN_PASSWORD="ec21d27e2fe4f9ed08a396cbd47b08b8e0a4ca3c"

RESOURCE USAGE & QUOTAS
```

If you get an error message, then the OpenNebula daemon could not be started properly:

```
$ oneuser show
Failed to open TCP connection to localhost:2633 (Connection refused - connect(2) for
↪ "localhost" port 2633)
```

The OpenNebula logs are located in `/var/log/one`, you should have at least the files `oned.log` and `sched.log`, the core and scheduler logs. Check `oned.log` for any error messages, marked with `[E]`.

Sunstone

Now you can try to log in into Sunstone web interface. To do this point your browser to `http://<frontend_address>:9869`. If everything is OK you will be greeted with a login page. The user is `oneadmin` and the password is the one in the file `/var/lib/one/.one/one_auth` in your Front-end.

If the page does not load, make sure you check `/var/log/one/sunstone.log` and `/var/log/one/sunstone.error`. Also, make sure TCP port 9869 is allowed through the firewall.

Directory Structure

The following table lists some notable paths that are available in your Front-end after the installation:

Path	Description
/etc/one/	Configuration Files
/var/log/one/	Log files, notably: oned.log, sched.log, sunstone.log and <vmid>.log
/var/lib/one/	oneadmin home directory
/var/lib/one/datastores/<dsid>/	Storage for the datastores
/var/lib/one/vms/<vmid>/	Action files for VMs (deployment file, transfer manager scripts, etc...)
/var/lib/one/.one/one_auth	oneadmin credentials
/var/lib/one/remotes/	Probes and scripts that will be synced to the Hosts
/var/lib/one/remotes/hooks/	Hook scripts
/var/lib/one/remotes/vmm/	Virtual Machine Manager Driver scripts
/var/lib/one/remotes/auth/	Authentication Driver scripts
/var/lib/one/remotes/im/	Information Manager (monitoring) Driver scripts
/var/lib/one/remotes/market/	MarketPlace Driver scripts
/var/lib/one/remotes/datastore/	Datastore Driver scripts
/var/lib/one/remotes/vnm/	Networking Driver scripts
/var/lib/one/remotes/tm/	Transfer Manager Driver scripts

2.2.8 Step 8. Next steps

Now that you have successfully started your OpenNebula service, head over to the *Node Installation* chapter in order to add hypervisors to your cloud.

Note: To change oneadmin password, follow the next steps:

```
#oneuser passwd 0 <PASSWORD>
#echo 'oneadmin:PASSWORD' > /var/lib/one/.one/one_auth
```

Test that everything works using *oneuser show*.

2.3 MySQL Setup

The MySQL/MariaDB back-end is an alternative to the default SQLite back-end. In this guide and in the rest of OpenNebula's documentation and configuration files we will refer to this database as the MySQL, however OpenNebula you can use either MySQL or MariaDB.

The two back-ends cannot coexist (SQLite and MySQL), and you will have to decide which one is going to be used while planning your OpenNebula installation.

Note: If you are planning to install OpenNebula with MySQL back-end, please follow this guide *prior* to start OpenNebula the first time to avoid problems with oneadmin and serveradmin credentials.

2.3.1 Installation

First of all, you need a working MySQL server. You can either deploy one for the OpenNebula installation or reuse any existing MySQL already deployed and accessible by the Front-end.

Configuring MySQL

You need to add a new user and grant it privileges on the `opennebula` database. This new database doesn't need to exist, OpenNebula will create it the first time you run it.

Assuming you are going to use the default values, log in to your MySQL server and issue the following commands:

```
$ mysql -u root -p
Enter password:
Welcome to the MySQL monitor. [...]

mysql> GRANT ALL PRIVILEGES ON opennebula.* TO 'oneadmin' IDENTIFIED BY '<thepassword>'
↵;
Query OK, 0 rows affected (0.00 sec)
```

Visit the [MySQL documentation](#) to learn how to manage accounts.

Now configure the transaction isolation level:

```
mysql> SET GLOBAL TRANSACTION ISOLATION LEVEL READ COMMITTED;
```

Configuring OpenNebula

Before you run OpenNebula for the first time, you need to set in `oned.conf` the connection details, and the database you have granted privileges on.

```
# Sample configuration for MySQL
DB = [ backend = "mysql",
        server  = "localhost",
        port    = 0,
        user    = "oneadmin",
        passwd  = "<thepassword>",
        db_name = "opennebula" ]
```

Fields:

- **server**: URL of the machine running the MySQL server.
- **port**: port for the connection to the server. If set to 0, the default port is used.
- **user**: MySQL user-name.
- **passwd**: MySQL password.
- **db_name**: Name of the MySQL database OpenNebula will use.

2.3.2 Using OpenNebula with MySQL

After this installation and configuration process you can use OpenNebula as usual.

NODE INSTALLATION

3.1 Overview

After OpenNebula Front-end is correctly setup the next step is preparing the hosts where the VMs are going to run.

3.1.1 How Should I Read This Chapter

Make sure you have properly *installed the Front-end* before reading this chapter.

This chapter focuses on the minimal node installation you need to follow in order to finish deploying OpenNebula. Concepts like storage and network have been simplified. Therefore feel free to follow the other specific chapters in order to configure other subsystems like networking and storage.

Note that you can follow this chapter without reading any other guides and you will be ready, by the end of it, to deploy a Virtual Machine. If in the future you want to switch to other storage or networking technologies you will be able to do so.

After installing the nodes and *verifying your installation*, you can either start using your cloud or configure more components:

- *Authenticaton*. (Optional) For integrating OpenNebula with LDAP/AD, or securing it further with other authentication technologies.
- *Sunstone*. OpenNebula GUI should working and accessible at this stage, but by reading this guide you will learn about specific enhanced configurations for Sunstone.

3.1.2 Hypervisor Compatibility

Section	Compatibility
<i>KVM Node Installation</i>	This Section applies to KVM.
<i>LXD Node Installation</i>	This Section applies to LXD.
<i>vCenter Node Installation</i>	This Section applies to vCenter.
<i>Verify your Installation</i>	This Section applies to vCenter, KVM and LXD.

If your cloud is KVM or LXD based you should also follow:

- *Open Cloud Host Setup*.
- *Open Cloud Storage Setup*.
- *Open Cloud Networking Setup*.

Otherwise, if it's VMware based:

- Head over to the *VMware Infrastructure Setup* chapter.

3.2 KVM Node Installation

This page shows you how to install OpenNebula from the binary packages.

Using the packages provided in our site is the recommended method, to ensure the installation of the latest version and to avoid possible packages divergences of different distributions. There are two alternatives here: you can add **our package repositories** to your system, or visit the [software menu](#) to **download the latest package** for your Linux distribution.

3.2.1 Step 1. Add OpenNebula Repositories

CentOS/RHEL 7

To add OpenNebula repository execute the following as root:

```
# cat << EOT > /etc/yum.repos.d/opennebula.repo
[opennebula]
name=opennebula
baseurl=https://downloads.opennebula.org/repo/5.7/CentOS/7/x86_64
enabled=1
gpgkey=https://downloads.opennebula.org/repo/repo.key
gpgcheck=1
#repo_gpgcheck=1
EOT
```

Debian/Ubuntu

To add OpenNebula repository on Debian/Ubuntu execute as root:

```
# wget -q -O- https://downloads.opennebula.org/repo/repo.key | apt-key add -
```

Debian 9

```
# echo "deb https://downloads.opennebula.org/repo/5.7/Debian/9 stable opennebula" > /etc/apt/sources
```

Ubuntu 14.04

```
# echo "deb https://downloads.opennebula.org/repo/5.7/Ubuntu/14.04 stable opennebula" > /etc/apt/sour
```

Ubuntu 16.04

```
# echo "deb https://downloads.opennebula.org/repo/5.7/Ubuntu/16.04 stable opennebula" > /etc/apt/sour
```

Ubuntu 18.04

```
# echo "deb https://downloads.opennebula.org/repo/5.7/Ubuntu/18.04 stable opennebula" > /etc/apt/sour
```

3.2.2 Step 2. Installing the Software

Installing on CentOS/RHEL

Execute the following commands to install the node package and restart libvirt to use the OpenNebula provided configuration file:

```
$ sudo yum install opennebula-node-kvm
$ sudo systemctl restart libvirtd
```

Note: You may benefit from using the more recent and feature-rich enterprise QEMU/KVM release. The differences between the base (`qemu-kvm`) and enterprise (`qemu-kvm-rhev` on RHEL or `qemu-kvm-ev` on CentOS) packages are described on the [Red Hat Customer Portal](#).

On CentOS 7, the enterprise packages are part of the separate repository. To replace the base packages, follow these steps:

```
$ sudo yum install centos-release-qemu-ev
$ sudo yum install qemu-kvm-ev
```

On RHEL 7, you need a paid subscription to the Red Hat Virtualization (RHV) or Red Hat OpenStack (RHOS) products, license only for the Red Hat Enterprise Linux isn't enough! You have to check the RHV [Installation Guide](#) for your licensed version. Usually, the following commands should enable and install the enterprise packages:

```
$ sudo subscription-manager repos --enable rhel-7-server-rhv-4-mgmt-agent-rpms
$ sudo yum install qemu-kvm-rhev
```

For further configuration, check the specific guide: *KVM*.

Installing on Debian/Ubuntu

Execute the following commands to install the node package and restart libvirt to use the OpenNebula provided configuration file:

```
$ sudo apt-get update
$ sudo apt-get install opennebula-node
$ sudo service libvirtd restart # debian
$ sudo service libvirt-bin restart # ubuntu
```

For further configuration check the specific guide: *KVM*.

3.2.3 Step 3. SELinux on CentOS/RHEL 7

Warning: If you are performing an upgrade skip this and the next steps and go back to the upgrade document.

SELinux can block some operations initiated by the OpenNebula Front-end, resulting in all the node operations fail completely (e.g., when `oneadmin` user's SSH credentials are not trusted) or only individual failures for particular operations with virtual machines. If the administrator isn't experienced in the SELinux configuration, **it's recommended to disable this functionality to avoid unexpected failures**. You can enable SELinux anytime later when you have the installation working.

Disable SELinux (recommended)

Change the following line in `/etc/selinux/config` to **disable** SELinux:

```
SELINUX=disabled
```

After the change, you have to reboot the machine.

Enable SELinux

Change the following line in `/etc/selinux/config` to enable SELinux in enforcing state:

```
SELINUX=enforcing
```

When changing from the `disabled` state, it's necessary to trigger filesystem relabel on the next boot by creating a file `/.autorelabel`, e.g.:

```
$ touch /.autorelabel
```

After the changes, you should reboot the machine.

Note: Based on your OpenNebula deployment type, the following may need to be required on your SELinux enabled KVM nodes:

- package `util-linux` newer than 2.23.2-51 installed
- SELinux boolean `virt_use_nfs` enabled (with datastores on NFS):

```
$ sudo setsebool -P virt_use_nfs on
```

Follow the [SELinux User's and Administrator's Guide](#) for more information on how to configure and troubleshoot the SELinux.

3.2.4 Step 4. Configure Passwordless SSH

OpenNebula Front-end connects to the hypervisor Hosts using SSH. You must distribute the public key of `oneadmin` user from all machines to the file `/var/lib/one/.ssh/authorized_keys` in all the machines. There are many methods to achieve the distribution of the SSH keys, ultimately the administrator should choose a method (the recommendation is to use a configuration management system). In this guide we are going to manually scp the SSH keys.

When the package was installed in the Front-end, an SSH key was generated and the `authorized_keys` populated. We will sync the `id_rsa`, `id_rsa.pub` and `authorized_keys` from the Front-end to the nodes. Additionally we need to create a `known_hosts` file and sync it as well to the nodes. To create the `known_hosts` file, we have to execute this command as user `oneadmin` in the Front-end with all the node names and the Front-end name as parameters:

```
$ ssh-keyscan <frontend> <node1> <node2> <node3> ... >> /var/lib/one/.ssh/known_hosts
```

Now we need to copy the directory `/var/lib/one/.ssh` to all the nodes. The easiest way is to set a temporary password to `oneadmin` in all the hosts and copy the directory from the Front-end:

```
$ scp -rp /var/lib/one/.ssh <node1>:/var/lib/one/
$ scp -rp /var/lib/one/.ssh <node2>:/var/lib/one/
$ scp -rp /var/lib/one/.ssh <node3>:/var/lib/one/
$ ...
```

You should verify that connecting from the Front-end, as user `oneadmin`, to the nodes and the Front-end itself, and from the nodes to the Front-end, does not ask password:

```
$ ssh <frontend>
$ exit

$ ssh <node1>
$ ssh <frontend>
$ exit
$ exit

$ ssh <node2>
$ ssh <frontend>
$ exit
$ exit

$ ssh <node3>
$ ssh <frontend>
$ exit
$ exit
```

If an extra layer of security is needed, it's possible to keep the private key just at the frontend node instead of copy it to all the hypervisor. In this fashion the `oneadmin` user in the hypervisors won't be able to access other hypervisors. This is achieved by modifying the `/var/lib/one/.ssh/config` in the front-end and adding the `ForwardAgent` option to the hypervisor hosts for forwarding the key:

```
$cat /var/lib/one/.ssh/config
Host host1
    User oneadmin
    ForwardAgent yes
Host host2
    User oneadmin
    ForwardAgent yes
```

Note: Remember that is necessary to have running the `ssh-agent` with the corresponding private key imported before OpenNebula is started. You can start `ssh-agent` by running `eval "$(ssh-agent -s)"` and add the private key by running `ssh-add /var/lib/one/.ssh/id_rsa`.

3.2.5 Step 5. Networking Configuration

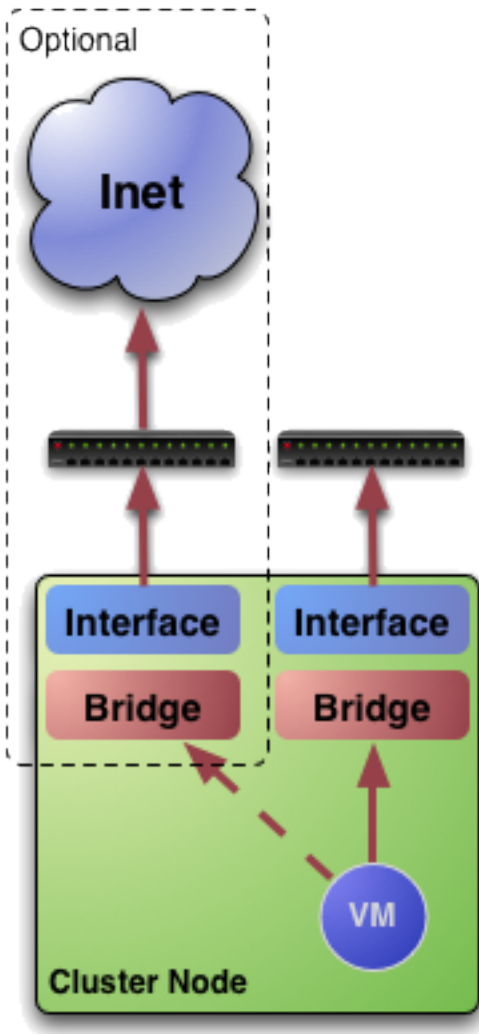

A network connection is needed by the OpenNebula Front-end daemons to access the hosts to manage and monitor the Hosts, and to transfer the Image files. It is highly recommended to use a dedicated network for this purpose.

There are various network models (please check the *Networking* chapter to find out the networking technologies supported by OpenNebula).

You may want to use the simplest network model that corresponds to the *bridged* drivers. For this driver, you will need to setup a linux bridge and include a physical device to the bridge. Later on, when defining the network in OpenNebula, you will specify the name of this bridge and OpenNebula will know that it should connect the VM to this bridge, thus giving it connectivity with the physical network device connected to the bridge. For example, a typical host with two physical networks, one for public IP addresses (attached to an `eth0` NIC for example) and the other for private virtual LANs (NIC `eth1` for example) should have two bridges:

```
$ brctl show
bridge name bridge id          STP enabled interfaces
br0         8000.001e682f02ac no         eth0
br1         8000.001e682f02ad no         eth1
```

Note: Remember that this is only required in the Hosts, not in the Front-end. Also remember that it is not important the exact name of the resources (br0, br1, etc...), however it's important that the bridges and NICs have the same name in all the Hosts.

3.2.6 Step 6. Storage Configuration

You can skip this step entirely if you just want to try out OpenNebula, as it will come configured by default in such a way that it uses the local storage of the Front-end to store Images, and the local storage of the hypervisors as storage for the running VMs.

However, if you want to set-up another storage configuration at this stage, like Ceph, NFS, LVM, etc, you should read the *Open Cloud Storage* chapter.

3.2.7 Step 7. Adding a Host to OpenNebula

In this step we will register the node we have installed in the OpenNebula Front-end, so OpenNebula can launch VMs in it. This step can be done in the CLI **or** in Sunstone, the graphical user interface. Follow just one method, not both, as they accomplish the same.

To learn more about the host subsystem, read this guide.

Adding a Host through Sunstone

Open the Sunstone as documented [here](#). In the left side menu go to Infrastructure -> Hosts. Click on the + button.

The fill-in the fqdn of the node in the Hostname field.

The screenshot shows the 'Create Host' interface in OpenNebula. The left sidebar contains navigation options: Dashboard, Instances, Templates, Storage, Network, Infrastructure (with sub-items Clusters, Hosts, Zones), System, and Settings. A 'Support' section indicates 'Not connected' with a 'Sign in' button. The main content area has a 'Create Host' title and a user 'oneadmin'. Below the title are 'Reset' and 'Create' buttons. The form includes a 'Type' dropdown set to 'KVM', a 'Cluster' dropdown set to '0: default', and a 'Hostname' text input field containing 'node01', which is circled in red.

Finally, return to the Hosts list, and check that the Host switch to ON status. It should take somewhere between 20s to 1m. Try clicking on the refresh button to check the status more frequently.

The screenshot shows the 'Hosts' list in OpenNebula. The left sidebar is identical to the previous screenshot. The main content area has a 'Hosts' title and a user 'oneadmin'. Below the title are several action buttons: a green '+' button, a refresh button circled in red, 'Select cluster', 'Enable', 'Disable', and 'Offline'. A search bar is on the right. Below the buttons is a table with the following data:

ID	Name	Cluster	RVMs	Allocated CPU	Allocated MEM	Status
2	node01	default	0	0 / 400 (0%)	0KB / 7.7GB (0%)	ON

The 'Status' cell for 'node01' is circled in red. Below the table, it says 'Showing 1 to 1 of 1 entries' and 'Previous 1 Next'. At the bottom, a summary shows '1 TOTAL 1 ON 0 OFF 0 ERROR'.

If the host turns to `err` state instead of `on`, check the `/var/log/one/oned.log`. Chances are it's a problem with the SSH!

Adding a Host through the CLI

To add a node to the cloud, run this command as `oneadmin` in the Front-end:

```
$ onehost create <node01> -i kvm -v kvm

$ onehost list
  ID NAME           CLUSTER  RVM  ALLOCATED_CPU  ALLOCATED_MEM  STAT
  1 localhost       default  0    -              -              - init

# After some time (20s - 1m)

$ onehost list
  ID NAME           CLUSTER  RVM  ALLOCATED_CPU  ALLOCATED_MEM  STAT
  0 node01         default  0    0 / 400 (0%)   0K / 7.7G (0%) on
```

If the host turns to `err` state instead of `on`, check the `/var/log/one/oned.log`. Chances are it's a problem with the SSH!

3.2.8 Step 8. Import Currently Running VMs (Optional)

You can skip this step as importing VMs can be done at any moment, however, if you wish to see your previously deployed VMs in OpenNebula you can use the import VM functionality.

3.2.9 Step 9. Next steps

You can now jump to the optional *Verify your Installation* section in order to get to launch a test VM.

Otherwise, you are ready to start using your cloud or you could configure more components:

- *Authenticator*. (Optional) For integrating OpenNebula with LDAP/AD, or securing it further with other authentication technologies.
- *Sunstone*. OpenNebula GUI should be working and accessible at this stage, but by reading this guide you will learn about specific enhanced configurations for Sunstone.
- *Open Cloud Host Setup*.
- *Open Cloud Storage Setup*.
- *Open Cloud Networking Setup*.

3.3 LXD Node Installation

The majority of the steps needed to install the LXD node are similar to KVM, because both rely on a Linux OS. Similar steps will have a link in the name and will be indicated by *Same as KVM*.

3.3.1 Step 1. Add OpenNebula Repositories

Same as KVM

3.3.2 Step 2. Installing the Software

LXD node is only supported on Ubuntu 1810, 1804 and 1604

Note: Ubuntu **1810** uses lxd snap package by default

Note: On Ubuntu **1604** you must install lxd3 from **xenial-backports**

Installing on Ubuntu

Install LXD node setup package:

```
$ sudo apt-get install opennebula-node-lxd
```

Run the following to use ceph storage drivers

```
$ sudo apt-get install rbd-nbd
```

For further configuration check the specific guide: *LXD*.

3.3.3 Step 4. Configure Passwordless SSH

Same as KVM

3.3.4 Step 5. Networking Configuration

Same as KVM

3.3.5 Step 6. Storage Configuration

Same as KVM

3.3.6 Step 7. Adding a Host to OpenNebula

Same as KVM

Replace `kvm` for `lxd` in the CLI and Sunstone

3.3.7 Step 8. Import Existing Containers (Optional)

You can use the import VM functionality if you want to manage pre-existing containers. It is required that containers aren't named under the pattern `one-<id>` in order to be imported. They need also to have `limits.cpu.allowance` `limits.cpu` and `limits.memory` keys defined, otherwise OpenNebula cannot import them. The `opennebula-node-lxd` package should setup the default template with these values.

3.3.8 Step 9. Next steps

Same as KVM

3.4 vCenter Node Installation

This Section lays out the requirements configuration needed in the vCenter and ESX instances in order to be managed by OpenNebula.

The VMware vCenter drivers enable OpenNebula to access one or more vCenter servers that manages one or more ESX Clusters. Each ESX Cluster is presented in OpenNebula as an aggregated hypervisor, i.e. as an OpenNebula Host. This means that the representation is one OpenNebula Host per ESX Cluster.

Note that OpenNebula scheduling decisions are therefore made at ESX Cluster level, vCenter then uses the DRS component to select the actual ESX host and Datastore to deploy the Virtual Machine.

3.4.1 Requirements

The following must be met for a functional vCenter environment:

- vCenter 5.5, 6.0 and/or 6.5, with at least one cluster aggregating at least one ESX 5.5, 6.0 and/or 6.5 host.
- Define a vCenter user for OpenNebula. This vCenter user (let's call her `oneadmin`) needs to have access to the ESX clusters that OpenNebula will manage. In order to avoid problems, the hassle free approach is to **declare this oneadmin user as Administrator**. Alternatively, in some enterprise environments declaring the user as Administrator is not allowed, in that case, you will need to grant permissions to perform some tasks. A table with the permissions requires is found at the end of this chapter.
- All ESX hosts belonging to the same ESX cluster to be exposed to OpenNebula **must** share at least one datastore among them.
- The ESX cluster **should** have DRS enabled. DRS is not required but it is recommended. OpenNebula does not schedule to the granularity of ESX hosts, DRS is needed to select the actual ESX host within the cluster, otherwise the VM will be launched in the ESX where the VM template has been created.
- If virtual standard switches are used, check that those switches exist in every ESX hosts belonging to the same ESX cluster, so the network represented by a port group can be used by a VM, no matter in what ESX host it's running. If you use distributed virtual switches, check that ESX hosts have been added to switches.
- To enable VNC functionality, please check the detailed information in section [VNC on ESX hosts](#) below.

Important: OpenNebula will **NOT** modify any vCenter configuration with some exceptions, the creation of virtual switches and port groups if the vcenter network driver is used and the creation of images for VMDK and/or ISO files.

Note: For security reasons, you may define different users to access different ESX Clusters. A different user can be defined in OpenNebula per ESX cluster, which is encapsulated in OpenNebula as an OpenNebula host.

3.4.2 Configuration

There are a few simple steps needed to configure OpenNebula so it can interact with vCenter:

Step 1: Check connectivity

The OpenNebula Front-end needs network connectivity to all the vCenters that it is supposed to manage.

Additionally, to enable VNC access to the spawned Virtual Machines, the Front-end also needs network connectivity to all the ESX hosts

Warning: OpenNebula uses port 443 to communicate with vCenter instances. Port 443 is the default port used by vCenter so unless you're filtering that port or you've configured a different port to listen for connections from the vSphere Web Client, OpenNebula will be able to connect with the right credentials.

Step 2: Configure the drivers in the Front-end (oned.conf) [Optional]

The following sections in the `/etc/one/oned.conf` file describe the information and virtualization drivers for vCenter, which are enabled by default:

```
#-----
#  vCenter Information Driver Manager Configuration
#  -r number of retries when monitoring a host
#  -t number of threads, i.e. number of hosts monitored at the same time
#-----
IM_MAD = [
    NAME           = "vcenter",
    SUNSTONE_NAME  = "VMWare vCenter",
    EXECUTABLE     = "one_im_sh",
    ARGUMENTS      = "-c -t 15 -r 0 vcenter" ]
#-----

#-----
#  vCenter Virtualization Driver Manager Configuration
#  -r number of retries when monitoring a host
#  -t number of threads, i.e. number of hosts monitored at the same time
#  -p more than one action per host in parallel, needs support from hypervisor
#  -s <shell> to execute commands, bash by default
#  -d default snapshot strategy. It can be either 'detach' or 'suspend'. It
#  defaults to 'suspend'.
#-----
VM_MAD = [
    NAME           = "vcenter",
    SUNSTONE_NAME  = "VMWare vCenter",
    EXECUTABLE     = "one_vmm_sh",
    ARGUMENTS      = "-p -t 15 -r 0 vcenter -s sh",
    default        = "vmm_exec/vmm_exec_vcenter.conf",
    TYPE           = "xml",
    IMPORTED_VMS_ACTIONS = "terminate, terminate-hard, hold, release, suspend,
        resume, delete, reboot, reboot-hard, resched, unresched, poweroff,
        poweroff-hard, disk-attach, disk-detach, nic-attach, nic-detach,
        snap-create, snap-delete"
]
#-----
```

As a Virtualization driver, the vCenter driver accept a series of parameters that control their execution. The parameters allowed are:

parameter	description
-r <num>	number of retries when executing an action
-t <num>	number of threads, i.e. number of actions done at the same time

See the Virtual Machine drivers reference for more information about these parameters, and how to customize and extend the drivers.

Additionally some behavior of the vCenter driver can be configured in the `/var/lib/one/remotes/etc/vmm/vcenter/vcenterc`. The parameters that can be changed here are as follows:

parameter	description
<code>:delete_images</code>	<code>Yes</code> : You can delete the images using OpenNebula. No: <code>VCENTER_IMPORTED</code> attribute will be set on imported images. This attribute prevents the image to be deleted.

OpenNebula needs to be restarted after any change in the `/etc/one/oned.conf` file, this can be done with the following command:

```
$ sudo systemctl restart opennebula
```

Step 3: Importing vCenter Clusters

OpenNebula ships with a powerful CLI tool to import vCenter clusters, VM Templates, Networks and running VMs. The tool `onevcenter` is self-explanatory, just set the credentials and FQDN/IP to access the vCenter host and follow on screen instructions.

If you need to know how to import vCenter clusters, check [vCenter import tool](#).

Once the vCenter cluster is monitored successfully ON will show as the host status. If ERROR is shown please check connectivity and have a look to the `/var/log/one/oned.log` file in order to find out the possible cause.

The following variables are added to OpenNebula hosts representing ESX clusters:

Operation	Note
<code>VCENTER_HOST</code>	hostname or IP of the vCenter host
<code>VCENTER_USER</code>	Name of the vCenter user
<code>VCENTER_PASSWORD</code>	Password of the vCenter user
<code>VCENTER_VERSION</code>	The vcenter version detected by OpenNebula e.g 5.5
<code>VCENTER_CCR_REF</code>	The Managed Object Reference to the vCenter cluster
<code>VCENTER_INSTANCE_ID</code>	The vCenter instance UUID identifier

Note: OpenNebula will create a special key at boot time and save it in `/var/lib/one/.one/one_key`. This key will be used as a private key to encrypt and decrypt all the passwords for all the vCenters that OpenNebula can access. Thus, the password shown in the OpenNebula host representing the vCenter is the original password encrypted with this special key.

Note: You have more information about what is a Managed Object Reference and what is the vCenter instance UUID in the [vCenter driver](#) section.

Step 4: Next Steps

Jump to the *Verify your Installation* section in order to launch a VM or learn how to setup the *VMWare infrastructure*.

3.4.3 Permissions requirement

If the user account that is going to be used in vCenter operations is not declared as an Administrator the following table summarizes the privileges required by the tasks performed in vCenter by OpenNebula:

Privileges	Notes
VirtualMachine.Interact.DeviceConnection	Required by a virtual machine reconfigure action
VirtualMachine.Interact.SetCDMedia	Required by a virtual machine reconfigure action
VirtualMachine.Interact.SetFloppyMedia	Required by a virtual machine reconfigure action
VirtualMachine.Config.Rename	Required by a virtual machine reconfigure action
VirtualMachine.Config.Annotation	Required by a virtual machine reconfigure action
VirtualMachine.Config.AddExistingDisk	Required by a virtual machine reconfigure action
VirtualMachine.Config.AddNewDisk	Required by a virtual machine reconfigure action
VirtualMachine.Config.RemoveDisk	Required by a virtual machine reconfigure action
VirtualMachine.Config.CPUCount	Required by a virtual machine reconfigure action
VirtualMachine.Config.Memory	Required by a virtual machine reconfigure action
VirtualMachine.Config.RawDevice	Required by a virtual machine reconfigure action
VirtualMachine.Config.AddRemoveDevice	Required by a virtual machine reconfigure action
VirtualMachine.Config.Settings	Required by a virtual machine reconfigure action
VirtualMachine.Config.AdvancedConfig	Required by a virtual machine reconfigure action
VirtualMachine.Config.SwapPlacement	Required by a virtual machine reconfigure action
VirtualMachine.Config.HostUSBDevice	Required by a virtual machine reconfigure action
VirtualMachine.Config.DiskExtend	Required by a virtual machine reconfigure action
VirtualMachine.Config.ChangeTracking	Required by a virtual machine reconfigure action
VirtualMachine.Provisioning.ReadCustSpecs	Required by a virtual machine reconfigure action
VirtualMachine.Inventory.CreateFromExisting	Required by a virtual machine reconfigure action
VirtualMachine.Inventory.CreateNew	Required by a virtual machine reconfigure action
VirtualMachine.Inventory.Move	Required by a virtual machine reconfigure action
VirtualMachine.Inventory.Register	Required by a virtual machine reconfigure action
VirtualMachine.Inventory.Remove	Required by a virtual machine reconfigure action
VirtualMachine.Inventory.Unregister	Required by a virtual machine reconfigure action
VirtualMachine.Inventory.Delete	Required to delete a virtual machine
VirtualMachine.Provisioning.DeployTemplate	Required to deploy a virtual machine from a particular template
VirtualMachine.Provisioning.CloneTemplate	Required to create a copy of a particular template
VirtualMachine.Interact.PowerOn	Required to power on a virtual machine
VirtualMachine.Interact.PowerOff	Required to power off or shutdown a virtual machine
VirtualMachine.Interact.Suspend	Required to suspend a virtual machine
VirtualMachine.Interact.Reset	Required to reset/reboot a VM's guest Operating System
VirtualMachine.Inventory.Delete	Required to delete a virtual machine or template
VirtualMachine.State.CreateSnapshot	Required to create a new snapshot of a virtual machine.
VirtualMachine.State.RemoveSnapshot	Required to remove snapshots from a virtual machine
VirtualMachine.State.RevertToSnapshot	Required to revert a virtual machine to a particular snapshot
Resource.AssignVirtualMachineToResourcePool	Required to assign a resource pool to a virtual machine
Resource.ApplyRecommendation	On all Storage Pods (Storage DRS cluster) represented by OpenNebula
Datastore.AllocateSpace	On all VMFS datastores represented by OpenNebula
Datastore.LowLevelFileOperations	On all VMFS datastores represented by OpenNebula

Table 1 – continued from previous page

Datastore.RemoveFile	On all VMFS datastores represented by OpenNebula
Datastore.Browse	On all VMFS datastores represented by OpenNebula
Datastore.FileManagement	On all VMFS datastores represented by OpenNebula
Network.Assign	Required on any network the Virtual Machine will be connected to
System.Read	Required to rename Uplink port group for a distributed switch only if you want OpenNebula to create distributed virtual switches
Host.Config.Network	Required on all ESX hosts where you want OpenNebula to create, update or delete distributed virtual switches
DVSwitch.CanUse	Required to connect a VirtualEthernetAdapter to a distributed virtual switch either to create or to modify
DVSwitch.Create	Required if you want OpenNebula to create distributed virtual switches
DVSwitch.HostOp	Required if you want OpenNebula to create distributed virtual switches
DVSwitch.PortSetting	Required if you want OpenNebula to create distributed virtual switches
DVSwitch.Modify	Required if you want OpenNebula to create distributed virtual switches
DVSwitch.Delete	Required if you want OpenNebula to destroy a distributed virtual switches that was previously created
DVPortgroup.Create	Required if you want OpenNebula to create distributed port groups
DVPortgroup.CanUse	Required to connect a VirtualEthernetAdapter to a distributed virtual port group either to create or to modify
DVPortgroup.Modify	Required if you want OpenNebula to create distributed port groups
DVPortgroup.Delete	Required if you want OpenNebula to destroy a distributed port group that was previously created

Special Permission

The above permissions except one can be set at the Cluster level. However, OpenNebula needs access to Customization spec for a successful monitoring. This is a special privilege cause it needs to be applied to vCenter server level. It means that if you try to apply the previous privileges into a cluster/datacenter and their inheritors, OpenNebula will fail and it will tell you that higher level permissions are necessary.

Our recommended approach is to create a two roles, one for the general permissions (“opennebulapermissions”) that can be applied in the Cluster level, and another to handle this single permission. This way, you can create a role managing all OpenNebula permissions and other role (called for instance readcustspec) with **only** the next one:

Privilege	Notes
VirtualMachine.Provisioning.ReadCustSpecs	Required by a virtual machine reconfigure action

Once you have created the proper role, one way to manage these privileges is creating two groups.

- The first group needs to be assigned the **readcustspec** role, place the OpenNebula user inside this group and grant permission over the vCenter instance to the group.
- The second groups needs to be assigned the **opennebulapermissions** role, place the OpenNebula user inside this group and grant permission over the desired cluster to the group.

Note: Do not forget to add the proper permissions to the datastores and any resource accessed by your OpenNebula user

3.4.4 VNC on ESX hosts

To enable VNC functionality, you need to allow access to the VNC ports on ESX hosts. By default, access to these ports is filtered by the firewall. We provide an installation package, which adds the **VNC** ruleset (port range 5900-11999 excluding known reserved ports) and permits access to these ports, also OpenNebula needs to be reconfigured to respect this specific VNC ports range. This package must be installed on each ESX host; it can be done via CLI or web UI. We’ll cover necessary steps for both ways here.

Locations of the VIB installation package or ZIP bundle:

- On your OpenNebula Front-end server, in `/usr/share/one/esx-fw-vnc/`. Installed as part of the package
 - **opennebula-server** on RHEL/CentOS
 - **opennebula** on Debian and Ubuntu.
- On public download server. In a case of installation problems, insecure HTTP access can be used at own risk!
 - <https://downloads.opennebula.org/packages/opennebula-5.7.90/fw-vnc-5.7.90.vib>
 - <https://downloads.opennebula.org/packages/opennebula-5.7.90/fw-vnc-5.7.90.zip>

Note: Make sure that the ESX hosts are reachable from the OpenNebula Front-end.

VNC range whitelisted on ESX hosts must be specified in the OpenNebula configuration located in `/etc/one/oned.conf`. Please change the `VNC_PORTS` section following way:

```
VNC_PORTS = [
  START      = 5900,
  RESERVED   = "5988:5989, 6999, 8000, 8042:8045, 8080, 8100, 8182, 8200, 8300:8302,
↪8889, 9000, 9080, 12000:65535"
]
```

and, restart OpenNebula:

```
$ sudo systemctl restart opennebula
```

Using CLI

Note: Please replace the placeholder variables `$ESX_HOST` (ESX hostname), `$ESX_USER` (access user name) and `$ESX_PSWD` (access user's password) with the valid access parameters depending on your infrastructure configuration.

Over SSH

If you have enabled direct SSH access on the ESX hosts, copy the VIB installation packages to the ESX host via `scp`. Login the ESX host via SSH, allow the community packages to be installed and do the install.

Note: The absolute path to the VIB must be provided.

```
$ scp /usr/share/one/esx-fw-vnc/fw-vnc.* $ESX_HOST:/tmp/
$ ssh $ESX_HOST
$ esxcli software acceptance set --level=CommunitySupported
$ esxcli software vib install -v /tmp/fw-vnc.vib
```

This enables VNC ports for any remote host. You should limit access to the VNC only from your OpenNebula Front-end. In this example, we restrict access only from IP address 192.168.0.1.

```
$ esxcli network firewall ruleset set --ruleset-id VNC --allowed-all false
$ esxcli network firewall ruleset allowedip add --ruleset-id VNC --ip-address 192.168.
↪0.1/32
$ esxcli network firewall ruleset allowedip list --ruleset-id VNC
```

Repeat for each ESX host.

VMware vSphere CLI

If you have a working VMware vSphere CLI, you can install the package remotely via `esxcli`.

First, check the CLI is working:

```
$ esxcli --server $ESX_HOST --username $ESX_USER --password $ESX_PSWD system version_
↳get
```

If the connection fails on untrusted fingerprint, please specify the valid one as an extra `esxcli` parameter `--thumbprint`. Example:

```
$ esxcli --server $ESX_HOST --username $ESX_USER --password $ESX_PSWD system version_
↳get
Connect to $ESX_HOST failed. Server SHA-1 thumbprint: 00:11:22:33:...:11:22:33 (not_
↳trusted).
$ esxcli --server $ESX_HOST --username $ESX_USER --password $ESX_PSWD --thumbprint
↳'00:11:22:33:...:11:22:33' system version get
Product: VMware ESXi
Version: 6.5.0
Build: Releasebuild-4887370
Update: 0
Patch: 9
```

Now, with all required connection parameters from a test above, use the `esxcli` to allow the community packages to be installed and proceed with the install.

Note: VIB must be accessible from the ESX host, as an absolute file path on the ESX host or downloadable URL.

```
$ esxcli <connection options> software acceptance set --level=CommunitySupported
$ esxcli <connection options> software vib install -v 'https://downloads.opennebula.
↳org/packages/opennebula-5.7.90/fw-vnc-5.7.90.vib'
```

This enables VNC ports for any remote host. You should limit access to the VNC only from your OpenNebula Front-end. In this example, we restrict access only from IP address 192.168.0.1.

```
$ esxcli <connection options> network firewall ruleset set --ruleset-id VNC --allowed-
↳all false
$ esxcli <connection options> network firewall ruleset allowedip add --ruleset-id VNC_
↳--ip-address 192.168.0.1/32
$ esxcli <connection options> network firewall ruleset allowedip list --ruleset-id VNC
```

Repeat for each ESX host.

Using UI

VIB package can also be installed over vSphere and ESX web UIs.

- Allow custom VIB package to be installed (in the vSphere client)
 - Login the vSphere client
 - Go to Home -> Inventories -> Hosts and Clusters
 - Select the ESX host and its tab **Manage** or **Configure** (depends on the vSphere version)

- Select **Security Profile** in the **System category**
- At the very bottom, select edit on **Host Image Profile Acceptance Level**
- Switch to **Community Supported** and confirm with **OK**

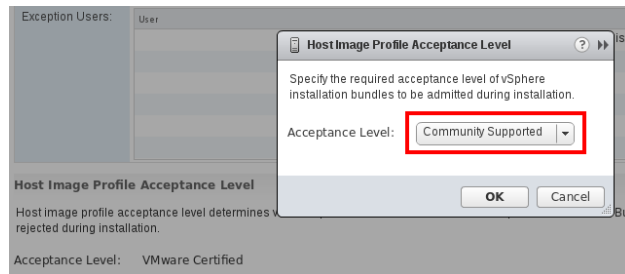

- Install VIB package (in the ESX host UI)
 - Login the ESX host UI
 - Go to Help -> Update in top right corner
 - Provide the VIB URL or absolute local path and click on **Update**



- Restrict VNC access to the OpenNebula Front-end only (in the vSphere client)
 - Go back again to the ESX host details in the vSphere client
 - Reload the vSphere page to see current data
 - Check again **Security Profile** in the **System category**, look on the Firewall/Incoming Connections for new **VNC** item
 - Click on **Edit** for the Firewall
 - Find the VNC and optionally restrict access only to your OpenNebula Front-end (e.g. for 192.168.0.1):

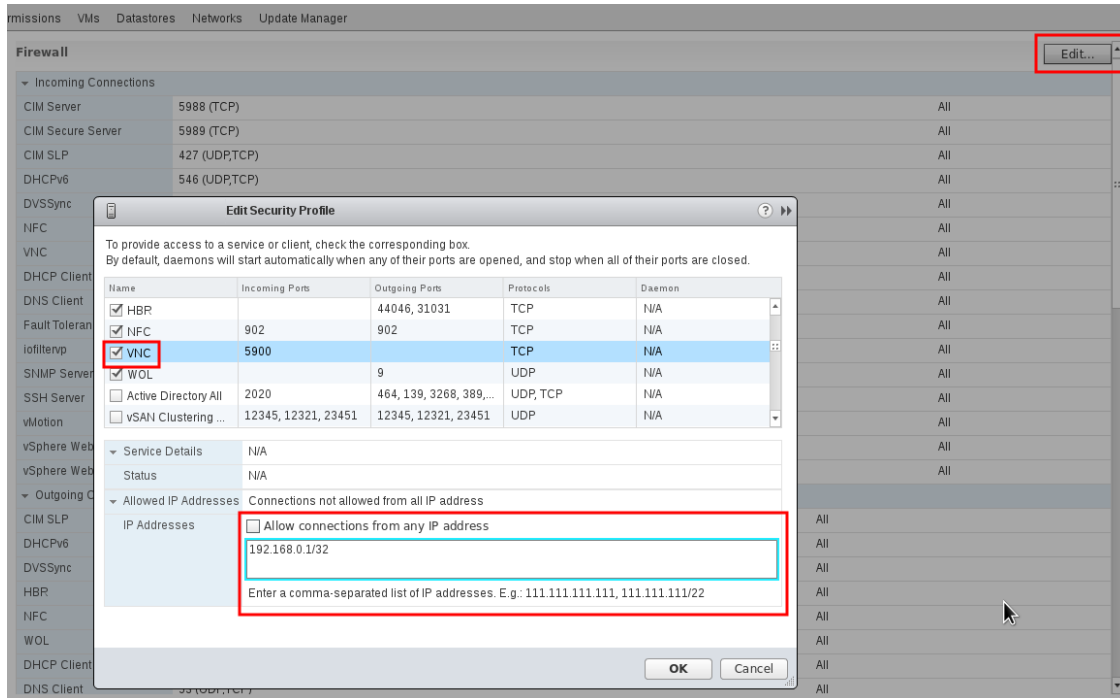

Repeat for each ESX host.

3.5 Verify your Installation

This chapter ends with this optional section, where you will be able to test your cloud by launching a virtual machine and test that everything is working correctly.

You should only follow the specific subsection for your hypervisor.

3.5.1 KVM/LXD based Cloud Verification

The goal of this subsection is to launch a small Virtual Machine, in this case a TTYLinux (which is a very small Virtual Machine just for testing purposes).

Requirements

To complete this section, you must have network connectivity to the Internet from the Front-end, in order to import an appliance from <http://marketplace.opennebula.systems>.

Step 1. Check that the Hosts are on

The Hosts that you have registered should be in ON status.

OpenNebula Hosts

oneadmin OpenNebula

+ [Refresh] Select cluster Enable Disable Offline Search

ID	Name	Cluster	RVMs	Allocated CPU	Allocated MEM	Status
2	node01	default	0	0 / 400 (0%)	0KB / 7.7GB (0%)	ON

Showing 1 to 1 of 1 entries Previous 1 Next

1 TOTAL 1 ON 0 OFF 0 ERROR

Support Not connected Sign in

OpenNebula 4.90.0 by OpenNebula Systems.

Step 2. Import an appliance from the MarketPlace.

We need to add an Image to our Cloud. To do so we can do so by navigating to Storage -> Apps in the left side menu (1). You will see a list of Appliances, you can filter by `tty kvm` (2) in order to find the one we are going to use in this guide. After that select it (3) and click to cloud button (4) in order to import it.

Open Nebula Apps

oneadmin OpenNebula

+ [Refresh] [Cloud] [Download] [Info] [User] [Refresh] [Delete]

Search: ttylinux-kvm 2

ID	Name	Owner	Group	Size	State	Registration Time	Marketplace	Zone
9	ttylinux-kvm	oneadmin	oneadmin	200MB	READY	01:00:00 01/01/1970	OpenNebula Public	0

Showing 1 to 1 of 1 entries (filtered from 16 total entries) Previous 1 Next

1 Apps

A dialog with the information of the appliance you have selected will pop up. You will need to select the datastore under the “Select the Datastore to store the resource” (1) and then click on the “Download” button (2)

Download App To OpenNebula

oneadmin OpenNebula

You selected the following datastore: **default**

ID	Owner	Group	Name	Capacity	Cluster	Type	Status
1	oneadmin	oneadmin	default	158.9GB / 461.5GB (34%)	0	IMAGE	ON

Showing 1 to 1 of 1 entries

Navigate now to the Storage -> Images tab and refresh until the Status of the Image switches to READY.

OpenNebula

Images

ID	Owner	Group	Name	Datastore	Type	Status	#VMS
0	oneadmin	oneadmin	ttylinux - kvm	default	OS	READY	0

Showing 1 to 1 of 1 entries

Step 3. Instantiate a VM

Navigate to Templates -> VMs, then select the `ttylinux - kvm` template that has been created and click on the “Instantiate”.

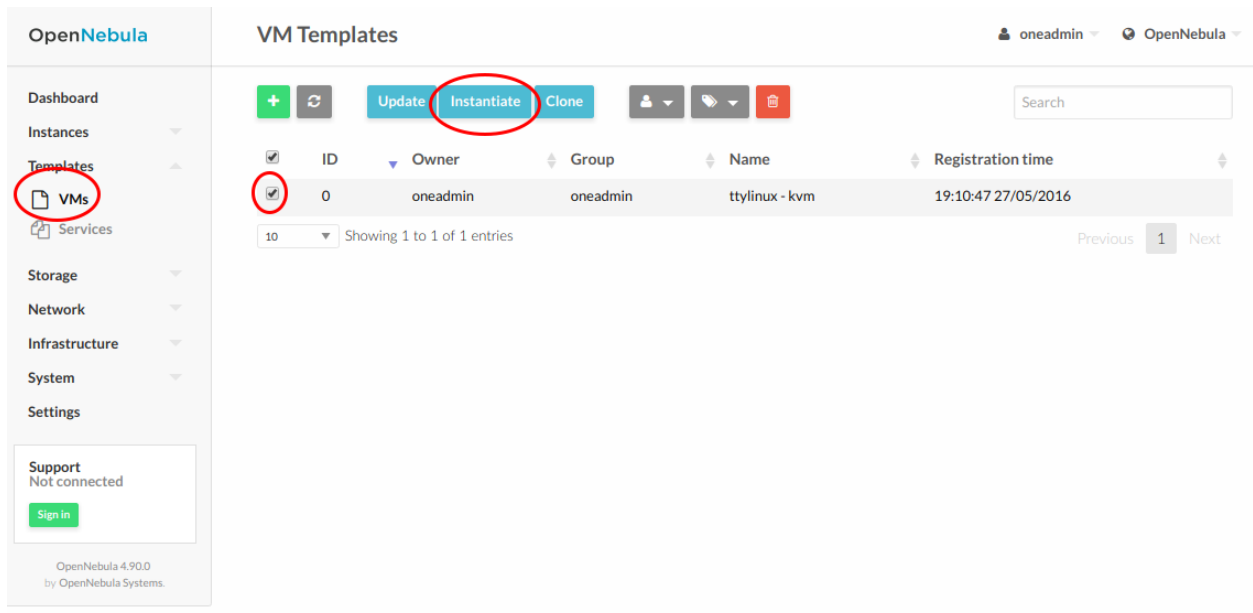

OpenNebula

VM Templates

oneadmin OpenNebula

+ Update **Instantiate** Clone

Search

<input checked="" type="checkbox"/>	ID	Owner	Group	Name	Registration time
<input checked="" type="checkbox"/>	0	oneadmin	oneadmin	ttylinux - kvm	19:10:47 27/05/2016

10 Showing 1 to 1 of 1 entries Previous 1 Next

Support
Not connected
Sign in

OpenNebula 4.90.0
by OpenNebula Systems

In this dialog simply click on the “Instantiate” button.

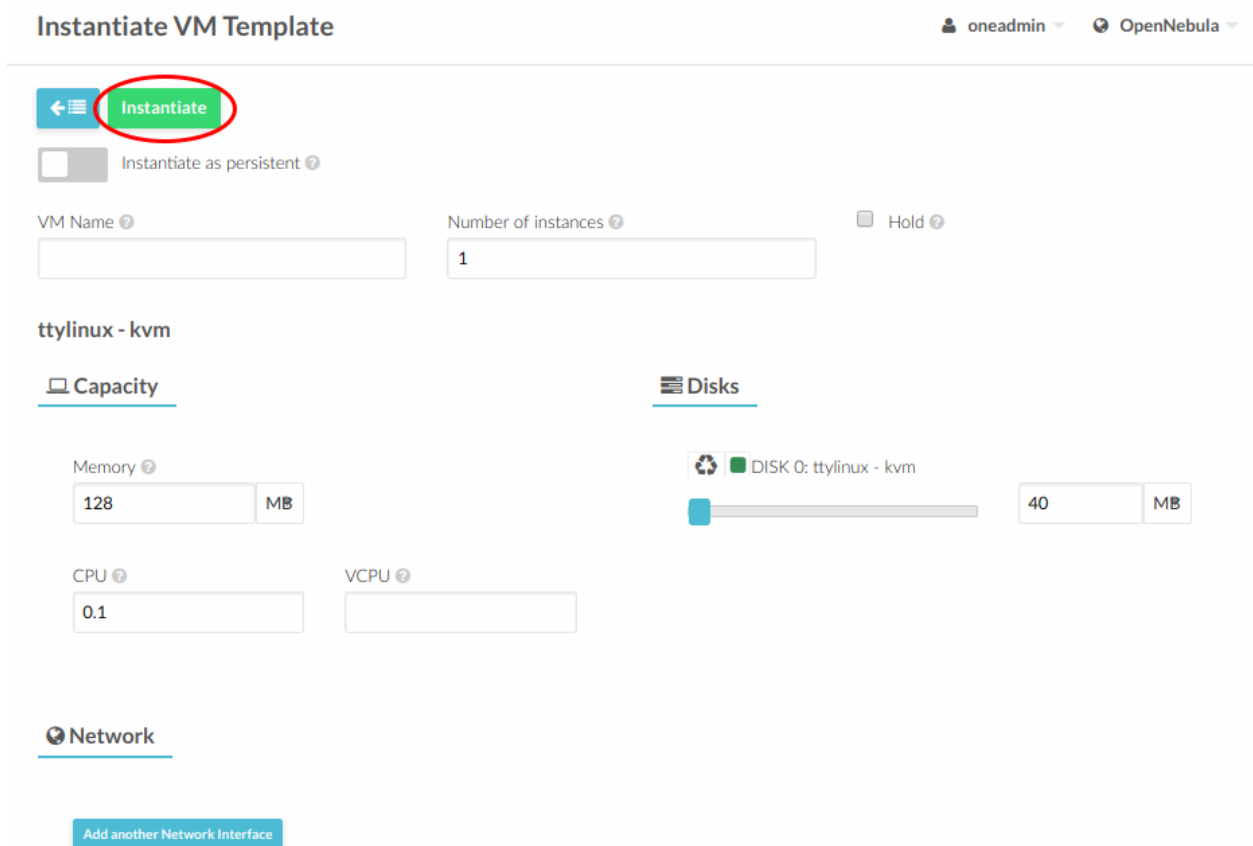

Instantiate VM Template

oneadmin OpenNebula

← Instantiate

Instantiate as persistent

VM Name

Number of instances Hold

ttylinux - kvm

Capacity

Memory MB

CPU VCPU

Disks

DISK 0: ttylinux - kvm MB

Network

Add another Network Interface

Step 4. Test VNC access

Navigate to Instances -> VMs. You will see that after a while the VM switches to Status `RUNNING` (you might need to click on the refresh button). Once it does, you can click on the VNC icon (at the right side of the image below).

If the VM fails, click on the VM and then in the `Log` tab to see why it failed. Alternatively, you can look at the log file `/var/log/one/<vmid>.log`.

Step 5. Adding Network connectivity to your VM

As you might have noticed, this VM does not have networking yet, this is because it depends a lot in your network technology. You would need to follow these steps in order to add Networking to the template.

1. Read the *Networking* chapter to choose a network technology, unless you have chosen to use the dummy driver explained in the *node installation* section and you have configured the bridges properly.
2. Create a new Network in the Network -> Virtual Networks dialog, and fill in the details of your network: like the Bridge, or the Physical Device, the IP ranges, etc.
3. Select the `ttylinux - kvm` template and update it. In the Network section of the template, select the network that you created in the previous step.
4. Instantiate and connect to the VM.

3.5.2 vCenter based Cloud Verification

In order to verify the correct installation of your OpenNebula cloud, follow the next steps. The following assumes that Sunstone is up and running, as explained in the *front-end installation Section*. To access Sunstone, point your browser to `http://<fontend_address>:9869`.

Step 1. Import a Datastore

Your vCenter VM templates use virtual disks and those virtual disks are stored in datastores. You must import into OpenNebula those vcenter datastores that contains the virtual disks.

Follow the steps to import datastores as described in the *vCenter Import Datastores Section*

Step 2. Import a VM Template

You will need a VM Template defined in vCenter, and then import it using the steps described in the [vCenter Import Templates Section](#).

Step 3. Instantiate the VM Template

You can easily instantiate the template to create a new VM from it using Sunstone. Proceed to the Templates tab of the left side menu, VMs Section, select the imported template and click on the Instantiate button.

The screenshot shows the 'Instantiate VM Template' interface in Sunstone. On the left is a navigation menu with 'Templates' selected. The main area contains a form with the following fields and options:

- Instantiate** (green button)
- Instantiate as persistent
- VM name:
- Number of instances:
- Start on hold
- Testplate** section with a penguin icon and 'Capacity' sub-section:
 - Memory: MB
 - CPU:
 - VCPU:
- Disks** section:
 - DISK 0: Testplate, MB

Step 4. Check the VM is Running

The scheduler should place the VM in the vCenter cluster imported as part of the [vCenter Node Installation Section](#).

After a few minutes (depending on the size of the disks defined by the VM Template), the state of the VM should be **RUNNING**. You can check the process in Sunstone in the Instances tab of the left side menu, VMs Section.

Once the VM is running, click on the VNC blue icon, and if you can see a console to the VM, congratulations! You have a fully functional OpenNebula cloud.

The screenshot shows the 'VMs' section in Sunstone. At the top, there are control buttons for adding, refreshing, and deleting VMs. Below is a table with the following data:

ID	Owner	Group	Name	Status	Host	IPs
0	oneadmin	oneadmin	TestVM	RUNNING	Cluster	--

Below the table, it says 'Showing 1 to 1 of 1 entries'. At the bottom, a summary bar shows: 1 TOTAL, 1 ACTIVE, 0 OFF, 0 PENDING, 0 FAILED.

The next step would be to further configure the OpenNebula cloud to suits your needs. You can learn more in the [VMware Infrastructure Setup guide](#).

3.5.3 Next steps

After this chapter, you are ready to start using your cloud or you could configure more components:

- *Authenticaton*. (Optional) For integrating OpenNebula with LDAP/AD, or securing it further with other authentication technologies.
- *Sunstone*. OpenNebula GUI should working and accessible at this stage, but by reading this guide you will learn about specific enhanced configurations for Sunstone.

If your cloud is KVM/LXD based you should also follow:

- *Open Cloud Host Setup*.
- *Open Cloud Storage Setup*.
- *Open Cloud Networking Setup*.

Otherwise, if it's VMware based:

- Head over to the *VMware Infrastructure Setup* chapter.

AUTHENTICATION SETUP

4.1 Overview

OpenNebula comes by default with an internal user/password authentication system, see the Users & Groups Subsystem guide for more information. You can enable an external Authentication driver.

4.1.1 Authentication

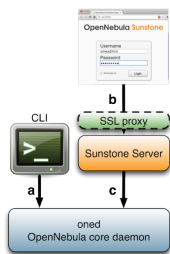

In the figure to the right of this text you can see three authentication configurations you can customize in OpenNebula.

a) CLI/API Authentication

You can choose from the following authentication drivers to access OpenNebula from the command line:

- Built-in User/Password and token authentication
- *SSH Authentication*
- *X509 Authentication*
- *LDAP Authentication*

b) Sunstone Authentication

By default any authentication driver configured to work with OpenNebula can be used out-of-the-box with Sunstone. Additionally you can add SSL security to Sunstone as described in the [Sunstone documentation](#)

c) Servers Authentication

This method is designed to delegate the authentication process to high level tools interacting with OpenNebula. You'll be interested in this method if you are developing your own servers.

By default, OpenNebula ships with two servers: *Sunstone* and EC2. When a user interacts with one of them, the server authenticates the request and then forwards the requested operation to the OpenNebula daemon.

The forwarded requests are encrypted by default using a Symmetric Key mechanism. The following guide shows how to strengthen the security of these requests using x509 certificates. This is specially relevant if you are running your server in a machine other than the front-end.

- *Cloud Servers Authentication*

4.1.2 How Should I Read This Chapter

When designing the architecture of your cloud you will have to choose where to store user's credentials. Different authentication methods can be configured at the same time and selected per user basis. One big distinction between the different authentication methods is the ability to be used by API, CLI and/or only Sunstone (web interface).

Can be used with API, CLI and Sunstone:

- Built-in User/Password
- LDAP

Can be used only with API and CLI:

- SSH

Can be used only with Sunstone:

- X509

The following sections are self-contained so you can directly go to the guide that describes the configuration for the chosen auth method.

4.1.3 Hypervisor Compatibility

Section	Compatibility
Built-in User/Password and token authentication	This Section applies to both KVM and vCenter.
<i>SSH Authentication</i>	This Section applies to both KVM and vCenter.
<i>X509 Authentication</i>	This Section applies to both KVM and vCenter.
<i>LDAP Authentication</i>	This Section applies to both KVM and vCenter.
<i>Sunstone documentation</i>	This Section applies to both KVM and vCenter.

4.2 SSH Authentication

This guide will show you how to enable and use the SSH authentication for the OpenNebula CLI. Using this authentication method, users login to OpenNebula with a token encrypted with their private ssh keys.

4.2.1 Requirements

You don't need to install any additional software.

4.2.2 Considerations & Limitations

With the current release, this authentication method is only valid to interact with OpenNebula using the CLI.

4.2.3 Configuration

OpenNebula Configuration

The Auth MAD and ssh authentication is enabled by default. In case it does not work make sure that the authentication method is in the list of enabled methods.

```
AUTH_MAD = [
  executable = "one_auth_mad",
  authn = "ssh,x509,ldap,server_cipher,server_x509"
]
```

There is an external plain user/password authentication driver, and existing accounts will keep working as usual.

4.2.4 Usage

Create New Users

This authentication method uses standard ssh RSA key pairs for authentication. Users can create these files **if they don't exist** using this command:

```
$ ssh-keygen -t rsa
```

OpenNebula commands look for the files generated at the standard location (`$HOME/.ssh/id_rsa`) so it is a good idea not to change the default path. It is also a good idea to protect the private key with a password.

The users requesting a new account have to generate a public key and send it to the administrator. The way to extract it is the following:

```
$ oneuser key
Enter PEM pass phrase:
MIIBCAKCAQEApUO+JISjSf02rFVtDrlyar/34EoUoVETx0n+RqWNav+5wi+gHiPp3e03AfEkXzjDYi8F
voS4a4456f1OUQlQddfyPECn590eX8Zu4DH3gp1VUuDeeE8WJWyAzdK5hg6F+RdyP1pT26mnyunZB8Xd
b1l8seoIAQiOS6t1VfA8FrtwLGmdEETfttS9ukyGxw5vdTplse/fcam+r9AXBR06zjc77x+DbRFbXcgI
1XIdpVrjCFL0fdN53L0aU7kTE9VNEXR×K8sPv1Nfx+FQWpX/HtH8ICs5WREsZGmXPAO/IkrSpMVg5taS
jie9JAQOMesjFIwgTWBUh6cNXuYsQ/5wIwIBIw==
```

The string written to the console must be sent to the administrator, so the can create the new user in a similar way as the default user/password authentication users.

The following command will create a new user with username 'newuser', assuming that the previous public key is saved in the text file `/tmp/pub_key`:

```
$ oneuser create newuser --ssh --read-file /tmp/pub_key
```

Instead of using the `--read-file` option, the public key could be specified as the second parameter.

If the administrator has access to the user's **private ssh key**, he can create new users with the following command:

```
$ oneuser create newuser --ssh --key /home/newuser/.ssh/id_rsa
```

Update Existing Users to SSH

You can change the authentication method of an existing user to SSH with the following commands:

```
$ oneuser chauth <id|name> ssh
$ oneuser passwd <id|name> --ssh --read-file /tmp/pub_key
```

As with the `create` command, you can specify the public key as the second parameter, or use the user's private key with the `--key` option.

User Login

Users must execute the 'oneuser login' command to generate a login token. The token will be stored in the `$ONE_AUTH` environment variable. The command requires the OpenNebula username, and the authentication method (`--ssh` in this case).

```
$ oneuser login newuser --ssh
```

The default ssh key is assumed to be in `~/.ssh/id_rsa`, otherwise the path can be specified with the `--key` option.

The generated token has a default **expiration time** of 10 hour. You can change that with the `--time` option.

4.3 x509 Authentication

This guide will show you how to enable and use the x509 certificates authentication with OpenNebula. The x509 certificates can be used in two different ways in OpenNebula.

The first option that is explained in this guide enables us to use certificates with the CLI. In this case the user will generate a login token with his private key, OpenNebula will validate the certificate and decrypt the token to authenticate the user.

The second option enables us to use certificates with Sunstone and the Public Cloud servers included in OpenNebula. In this case the authentication is leveraged to Apache or any other SSL capable HTTP proxy that has to be configured by the administrator. If this certificate is validated the server will encrypt those credentials using a server certificate and will send the token to OpenNebula.

4.3.1 Requirements

If you want to use the x509 certificates with Sunstone or one of the Public Clouds, you must deploy a SSL capable HTTP proxy on top of them in order to handle the certificate validation.

4.3.2 Considerations & Limitations

The X509 driver uses the certificate DN as user passwords. The x509 driver will remove any space in the certificate DN. This may cause problems in the unlikely situation that you are using a CA signing certificate subjects that only differ in spaces.

4.3.3 Configuration

The following table summarizes the available options for the x509 driver (`/etc/one/auth/x509_auth.conf`):

VARIABLE	VALUE
<code>:ca_dir</code>	Path to the trusted CA directory. It should contain the trusted CA's for the server, each CA certificate should be name <code>CA_hash.0</code>
<code>:check_crl</code>	By default, if you place CRL files in the CA directory in the form <code>CA_hash.r0</code> , OpenNebula will check them. You can enforce CRL checking by defining <code>:check_crl</code> , i.e. authentication will fail if no CRL file is found. You can always disable this feature by moving or renaming <code>.r0</code> files

Follow these steps to change oneadmin's authentication method to x509:

Warning: You should have another account in the oneadmin group, so you can revert these steps if the process fails.

- *Change the oneadmin password* to the oneadmin certificate DN.

```
$ oneuser chauth 0 x509 --x509 --cert /tmp/newcert.pem
```

- *Add trusted CA certificates* to the certificates directory

```
$ openssl x509 -noout -hash -in cacert.pem
78d0bbd8

$ sudo cp cacert.pem /etc/one/auth/certificates/78d0bbd8.0
```

- *Create a login* for oneadmin using the `-x509` option. This token has a default expiration time set to 1 hour, you can change this value using the option `-time`.

```
$ oneuser login oneadmin --x509 --cert newcert.pem --key newkey.pem
Enter PEM pass phrase:
export ONE_AUTH=/home/oneadmin/.one/one_x509
```

- Set `ONE_AUTH` to the x509 login file

```
$ export ONE_AUTH=/home/oneadmin/.one/one_x509
```

4.3.4 Usage

Add and Remove Trusted CA Certificates

You need to copy all trusted CA certificates to the certificates directory, renaming each of them as `<CA_hash>.0`. The hash can be obtained with the `openssl` command:

```
$ openssl x509 -noout -hash -in cacert.pem
78d0bbd8

$ sudo cp cacert.pem /etc/one/auth/certificates/78d0bbd8.0
```

To stop trusting a CA, simply remove its certificate from the certificates directory.

This process can be done without restarting OpenNebula, the driver will look for the certificates each time an authentication request is made.

Create New Users

The users requesting a new account have to send their certificate, signed by a trusted CA, to the administrator. The following command will create a new user with username 'newuser', assuming that the user's certificate is saved in the file /tmp/newcert.pem:

```
$ oneuser create newuser --x509 --cert /tmp/newcert.pem
```

This command will create a new user whose password contains the subject DN of his certificate. Therefore if the subject DN is known by the administrator the user can be created as follows:

```
$ oneuser create newuser --x509 "user_subject_DN"
```

Update Existing Users to x509 & Multiple DN

You can change the authentication method of an existing user to x509 with the following command:

- Using the user certificate:

```
$ oneuser chauth <id|name> x509 --x509 --cert /tmp/newcert.pem
```

- Using the user certificate subject DN:

```
$ oneuser chauth <id|name> x509 --x509 "user_subject_DN"
```

You can also map multiple certificates to the same OpenNebula account. Just add each certificate DN separated with '|' to the password field.

```
$ oneuser passwd <id|name> --x509 "/DC=es/O=one/CN=user|/DC=us/O=two/CN=user"
```

User Login

Users must execute the 'oneuser login' command to generate a login token. The token will be stored in the \$ONE_AUTH environment variable. The command requires the OpenNebula username, and the authentication method (--x509 in this case).

```
newuser@frontend $ oneuser login newuser --x509 --cert newcert.pem --key newkey.pem
Enter PEM pass phrase:
```

The generated token has a default **expiration time** of 10 hours. You can change that with the --time option.

4.3.5 Tuning & Extending

The x509 authentication method is just one of the drivers enabled in AUTH_MAD. All drivers are located in /var/lib/one/remotes/auth.

OpenNebula is configured to use x509 authentication by default. You can customize the enabled drivers in the AUTH_MAD attribute of *oned.conf*. More than one authentication method can be defined:

```
AUTH_MAD = [
  executable = "one_auth_mad",
  authn = "ssh,x509,ldap,server_cipher,server_x509"
]
```

4.3.6 Enabling x509 auth in Sunstone

Update the `/etc/one/sunstone-server.conf` `:auth` parameter to use the x509 auth:

```
:auth: x509
```

4.4 LDAP Authentication

The LDAP Authentication add-on permits users to have the same credentials as in LDAP, so effectively centralizing authentication. Enabling it will let any correctly authenticated LDAP user to use OpenNebula.

4.4.1 Prerequisites

Warning: This Add-on requires the `'net/ldap'` ruby library provided by the `'net-ldap'` gem.

This Add-on will not install any LDAP server or configure it in any way. It will not create, delete or modify any entry in the LDAP server it connects to. The only requirement is the ability to connect to an already running LDAP server and being able to perform a successful `ldapbind` operation and have a user able to perform searches of users, therefore no special attributes or values are required in the LDIF entry of the user authenticating.

4.4.2 Configuration

Configuration file for auth module is located at `/etc/one/auth/ldap_auth.conf`. This is the default configuration:

```
server 1:
  # Ldap user able to query, if not set connects as anonymous. For
  # Active Directory append the domain name. Example:
  # Administrator@my.domain.com
  #:user: 'admin'
  #:password: 'password'

  # Ldap authentication method
  :auth_method: :simple

  # Ldap server
  :host: localhost
  :port: 389

  # Connection and authentication timeout
  #:timeout: 15

  # Uncomment this line for tls connections
```

(continues on next page)

(continued from previous page)

```

#:encryption: :simple_tls

# base hierarchy where to search for users and groups
:base: 'dc=domain'

# group the users need to belong to. If not set any user will do
#:group: 'cn=cloud,ou=groups,dc=domain'

# field that holds the user name, if not set 'cn' will be used
:user_field: 'cn'

# for Active Directory use this user_field instead
#:user_field: 'sAMAccountName'

# field name for group membership, by default it is 'member'
#:group_field: 'member'

# user field that that is in in the group group_field, if not set 'dn' will be_
↪used
#:user_group_field: 'dn'

# Generate mapping file from group template info
:mapping_generate: true

# Seconds a mapping file remain untouched until the next regeneration
:mapping_timeout: 300

# Name of the mapping file in OpenNebula var directory
:mapping_filename: server1.yaml

# Key from the OpenNebula template to map to an AD group
:mapping_key: GROUP_DN

# Default group ID used for users in an AD group not mapped
:mapping_default: 1

# use RFC2307bis for groups
# if false, depending on your LDAP server configuration,
# set user_field and user_group_field 'uid' and group_field 'memberUid'
:rfc2307bis: true

# this example server wont be called as it is not in the :order list
server 2:
  :auth_method: :simple
  :host: localhost
  :port: 389
  :base: 'dc=domain'
  #:group: 'cn=cloud,ou=groups,dc=domain'
  :user_field: 'cn'

# List the order the servers are queried
#
# :order is defined as a list of server names and/or nested lists
# of server names (representing the availability group). The servers
# in the main list are consulted in the order they are written until
# the authentication succeeds. In the nested server lists (avail.

```

(continues on next page)

(continued from previous page)

```

# groups), user is authenticated only against the first online server.
# If user is passed/refused by the server in the availability group,
# no other server is consulted from the same group, but
# the authentication process continues with the next server/group in
# the main list.
#
# Examples:
#
# 1) simple list
# :order:
#   - server1
#   - server2
#   - server3
#
# 2) list with availability group
# :order:
#   - server1
#   - ['server2', 'server3', 'server4'] # availability group
#   - server5
#
:order:
  - server 1
  #- server 2

```

The structure is a hash where any key different to `:order` will contain the configuration of one LDAP server we want to query. The special key `:order` holds an array with the order we want to query the configured servers.

Note: Items of the `:order` are the server names or nested arrays of server names representing the **availability group**. The items in the `:order` are processed one by one until the user is successfully authenticated, or the end of the list is reached. Inside the availability group, only the very first server which can be successfully connected is queried. Any server not listed in `:order` won't be queried.

VARIABLE	DESCRIPTION
<code>:user</code>	Name of the user that can query LDAP. Do not set it if you can perform queries anonymously
<code>:password</code>	Password for the user defined in <code>:user</code> . Do not set if anonymous access is enabled
<code>:auth_method</code>	Only <code>:simple</code> is supported
<code>:encryption</code>	Can be set to <code>:simple_tls</code> if SSL connection is needed
<code>:host</code>	Host name of the LDAP server
<code>:port</code>	Port of the LDAP server
<code>:timeout</code>	Connection and authentication timeout
<code>:base</code>	Base leaf where to perform user searches
<code>:group</code>	If set the users need to belong to this group
<code>:user_field</code>	Field in LDAP that holds the user name
<code>:mapping_generate</code>	Generate automatically a mapping file. It can be disabled in case it needs to be done manually
<code>:mapping_timeout</code>	Number of seconds between automatic mapping file generation
<code>:mapping_file</code>	Name of the mapping file. Should be different for each server
<code>:mapping_key</code>	Key in the group template used to generate the mapping file. It should hold the DN of the mapped group
<code>:mapping_default</code>	Default group used when no mapped group is found. Set to false in case you don't want the user to be authorized if it does not belong to a mapped group
<code>:rfc2307bis</code>	Set to true when using Active Directory, false when using LDAP. Make sure you configure <code>user_group_field</code> and <code>group_field</code>

To enable `ldap` authentication the described parameters should be configured. OpenNebula must be also configured to enable external authentication. Add this line in `/etc/one/oned.conf`

```
DEFAULT_AUTH = "ldap"
```

4.4.3 User Management

Using LDAP authentication module the administrator doesn't need to create users with `oneuser` command as this will be automatically done.

Users can store their credentials into `$ONE_AUTH` file (usually `$HOME/.one/one_auth`) in this fashion:

```
<user_dn>:ldap_password
```

where

- `<user_dn>` the DN of the user in the LDAP service
- `ldap_password` is the password of the user in the LDAP service

Alternatively a user can generate an authentication token using the `oneuser login` command, so there is no need to keep the LDAP password in a plain file. Simply input the `ldap_password` when requested. More information on the management of login tokens and `$ONE_AUTH` file can be found in [Managing Users Guide](#).

DN's With Special Characters

When the user dn or password contains blank spaces the LDAP driver will escape them so they can be used to create OpenNebula users. Therefore, users needs to set up their `$ONE_AUTH` file accordingly.

Users can easily create escaped `$ONE_AUTH` tokens with the command `oneuser encode <user> [<password>]`, as an example:

```
$ oneuser encode 'cn=First Name,dc=institution,dc=country' 'pass word'
cn=First%20Name,dc=institution,dc=country:pass%20word
```

The output of this command should be put in the `$ONE_AUTH` file.

4.4.4 Active Directory

LDAP Auth drivers are able to connect to Active Directory. You will need:

- Active Directory server with support for simple user/password authentication.
- User with read permissions in the Active Directory user's tree.

You will need to change the following values in the configuration file (`/etc/one/auth/ldap_auth.conf`):

- `:user:` the Active Directory user with read permissions in the user's tree plus the domain. For example for user **Administrator** at domain **win.opennebula.org** you specify it as `Administrator@win.opennebula.org`
- `:password:` password of this user
- `:host:` hostname or IP of the Domain Controller
- `:base:` base DN to search for users. You need to decompose the full domain name and use each part as DN component. Example, for `win.opennebula.org` you will get the base DN: `DN=win,DN=opennebula,DN=org`

- `:user_field`: set it to `sAMAccountName`

4.4.5 Group Mapping

You can make new users belong to an specific group or groups. To do this a mapping is generated from the LDAP group to an existing OpenNebula group. This system uses a mapping file specified by `:mapping_file` parameter and resides in OpenNebula `var` directory. The mapping file can be generated automatically using data in the group template that tells which LDAP group maps to that specific group. For example we can add in the group template this line:

```
GROUP_DN="CN=technicians,CN=Groups,DC=example,DC=com"
```

And in the LDAP configuration file we set the `:mapping_key` to `GROUP_DN`. This tells the driver to look for the group DN in that template parameter. This mapping expires the number of seconds specified by `:mapping_timeout`. This is done so the authentication is not continually querying OpenNebula.

You can also disable the automatic generation of this file and do the mapping manually. The mapping file is in YAML format and contains a hash where the key is the LDAP's group DN and the value is the ID of the OpenNebula group. For example:

```
CN=technicians,CN=Groups,DC=example,DC=com: '100'
CN=Domain Admins,CN=Users,DC=example,DC=com: '101'
```

When several servers are configured you should have different `:mapping_key` and `:mapping_file` values for each one so they don't collide. For example:

```
internal:
  :mapping_file: internal.yaml
  :mapping_key: INTERNAL_GROUP_DN

external:
  :mapping_file: external.yaml
  :mapping_key: EXTERNAL_GROUP_DN
```

And in the OpenNebula group template you can define two mappings, one for each server:

```
INTERNAL_GROUP_DN="CN=technicians,CN=Groups,DC=internal,DC=com"
EXTERNAL_GROUP_DN="CN=staff,DC=other-company,DC=com"
```

Note: If the map is updated (e.g. you change the LDAP DB) the user groups will be updated next time the user is authenticated. Also note that a user maybe using a login token that needs to expire to this changes to take effect. The max. life time of a token can be set in `oned.conf` per each driver. If you want the OpenNebula core not to update user groups (and control group assignment from OpenNebula) update `DRIVER_MANAGED_GROUPS` in the `ldap AUTH_MAD_CONF` configuration attribute.

4.4.6 Enabling LDAP auth in Sunstone

Update the `/etc/one/sunstone-server.conf` `:auth` parameter to use the `opennebula`:

```
:auth: opennebula
```

Using this method the credentials provided in the login screen will be sent to the OpenNebula core and the authentication will be delegated to the OpenNebula auth system, using the specified driver for that user. Therefore any OpenNebula auth driver can be used through this method to authenticate the user (i.e: LDAP).

To automatically encode credentials as explained in *DN's with special characters* section also add this parameter to sunstone configuration:

```
:encode_user_password: true
```

SUNSTONE SETUP

5.1 Overview

OpenNebula Sunstone is a Graphical User Interface (GUI) intended for both end users and administrators that simplifies the typical management operations in private and hybrid cloud infrastructures. OpenNebula Sunstone allows to easily manage all OpenNebula resources and perform typical operations on them.

The screenshot displays the OpenNebula Sunstone Dashboard. On the left is a navigation sidebar with categories: Dashboard, Instances (VMs, Services), Templates, Storage, Network, Infrastructure (Clusters, Hosts, Zones), System, and Settings. A 'Support' section at the bottom of the sidebar indicates 'Not connected' with a 'Sign in' button and version information: 'OpenNebula 4.90.0 by OpenNebula Systems.'

The main dashboard area is titled 'Dashboard' and shows the user 'oneadmin' and the system 'OpenNebula'. It features several sections:

- VMs 7**: ACTIVE 7, PENDING 0, FAILED 0. Includes three stacked bar charts for CPU hours, Memory GB hours, and Disk MB hours.
- Hosts 2**: ON 1, OFF 1, ERROR 0. Includes four progress bars for Allocated CPU (310 / 2800), Allocated Memory (6.1GB / 523.7GB), Real CPU (322 / 2800), and Real Memory (18.4GB / 523.7GB).
- Users 9**: Includes three stacked bar charts for CPU hours, Memory GB hours, and Disk MB hours.
- Images 3**: USED 423MB.
- Virtual Networks 1**: USED IPs 6.

5.1.1 How Should I Read this Chapter

The *Sunstone Installation & Configuration* section describes the configuration and customization options for Sunstone. After Sunstone is running, you can define different sunstone behaviors for each user role in the *Sunstone Views* section. For more information on how to customize and extend you Sunstone deployment use the following links:

- *Security & Authentication Methods*, improve security with x509 authentication and SSL
- *Cloud Servers Authentication*, advanced reference about the security between Sunstone and OpenNebula.
- *Advanced Deployments*, improving scalability and isolating the server

5.1.2 Hypervisor Compatibility

Sunstone is available for all the hypervisors. When using vCenter, the cloud admin should enable the `admin_vcenter`, `groupadmin_vcenter` and `cloud_vcenter` *Sunstone views*.

5.2 Sunstone Installation & Configuration

5.2.1 Requirements

You must have an OpenNebula site properly configured and running to use OpenNebula Sunstone, be sure to check the *OpenNebula Installation and Configuration Guides* to set up your private cloud first. This section also assumes that you are familiar with the configuration and use of OpenNebula.

OpenNebula Sunstone was installed during the OpenNebula installation. If you followed the *installation guide* then you already have all ruby gem requirements. Otherwise, run the `install_gem` script as root:

```
# /usr/share/one/install_gems sunstone
```

The Sunstone Operation Center offers the possibility of starting a VNC/SPICE session to a Virtual Machine. This is done by using a VNC/SPICE websocket-based client (noVNC) on the client side and a VNC proxy translating and redirecting the connections on the server-side.

Warning: The SPICE Web client is a prototype and is limited in function. More information of this component can be found in the following [link](#)

Warning: Make sure that there is free space in sunstone's log directory or it will die silently. By default the log directory is `/var/log/one`.

Requirements:

- Websockets-enabled browser (optional): Firefox and Chrome support websockets. In some versions of Firefox manual activation is required. If websockets are not enabled, flash emulation will be used.
- Installing the python-numpy package is recommended for a better vnc performance.

5.2.2 Configuration

sunstone-server.conf

The Sunstone configuration file can be found at `/etc/one/sunstone-server.conf`. It uses YAML syntax to define some options:

Available options are:

Option	Description
<code>:tmpdir</code>	Uploaded images will be temporarily stored in this folder before being copied to OpenNebula
<code>:one_xmlrpc</code>	OpenNebula daemon host and port
<code>:one_xmlrpc_timeout</code>	Configure the timeout (seconds) for XMLRPC calls from sunstone. See Shell Environment variables
<code>:host</code>	IP address on which the server will listen on. <code>0.0.0.0</code> by default.
<code>:port</code>	Port on which the server will listen. <code>9869</code> by default.
<code>:sessions</code>	Method of keeping user sessions. It can be <code>memory</code> or <code>memcache</code> . For server that spawn more than one
<code>:memcache_host</code>	Host where memcached server resides
<code>:memcache_port</code>	Port of memcached server
<code>:memcache_namespace</code>	memcache namespace where to store sessions. Useful when memcached server is used by more services
<code>:debug_level</code>	Log debug level: <code>0 = ERROR</code> , <code>1 = WARNING</code> , <code>2 = INFO</code> , <code>3 = DEBUG</code>
<code>:env</code>	Execution environment for Sunstone. <code>dev</code> , Instead of pulling the minified js all the files will be pulled (ap
<code>:max_upload_file_size</code>	Maximum allowed size of uploaded images (in bytes). Leave commented for unlimited size
<code>:auth</code>	Authentication driver for incoming requests. Possible values are <code>sunstone</code> , <code>openebula</code> , <code>remote</code> an
<code>:core_auth</code>	Authentication driver to communicate with OpenNebula core. Possible values are <code>x509</code> or <code>cipher</code> . Che
<code>:encode_user_password</code>	For external authentication drivers, such as LDAP. Performs a URL encoding on the credentials sent to Op
<code>:lang</code>	Default language for the Sunstone interface. This is the default language that will be used if user has not c
<code>:vnc_proxy_port</code>	Base port for the VNC proxy. The proxy will run on this port as long as Sunstone server does. <code>29876</code> by
<code>:vnc_proxy_support_wss</code>	<code>yes</code> , <code>no</code> , <code>only</code> . If enabled, the proxy will be set up with a certificate and a key to use secure websockets.
<code>:vnc_proxy_cert</code>	Full path to certificate file for wss connections.
<code>:vnc_proxy_key</code>	Full path to key file. Not necessary if key is included in certificate.
<code>:vnc_proxy_ipv6</code>	Enable ipv6 for novnc. (<code>true</code> or <code>false</code>)
<code>:vnc_client_port</code>	Port where the vnc JS client will connect. If not set, will use the port section of <code>:vnc_proxy_port</code>
<code>:vnc_request_password</code>	Request VNC password for external windows, by default it will not be requested (<code>true</code> or <code>false</code>)
<code>:table_order</code>	Default table order, resources get ordered by ID in <code>asc</code> or <code>desc</code> order.
<code>:marketplace_username</code>	Username credential to connect to the Marketplace.
<code>:marketplace_password</code>	Password to connect to the Marketplace.
<code>:marketplace_url</code>	Endpoint to connect to the Marketplace. If commented, a <code>503 service unavailable</code> error will be r
<code>:oneflow_server</code>	Endpoint to connect to the OneFlow server.
<code>:routes</code>	List of files containing custom routes to be loaded. Check server plugins for more info.
<code>:mode</code>	Default views directory.
<code>:keep_me_logged</code>	True to display 'Keep me logged in' option in Sunstone login.

Starting Sunstone

To start Sunstone just issue the following command as `oneadmin`

```
# service opennebula-sunstone start
```

You can find the Sunstone server log file in `/var/log/one/sunstone.log`. Errors are logged in `/var/log/one/sunstone.error`.

5.2.3 Commercial Support Integration

We are aware that in production environments, access to professional, efficient support is a must, and this is why we have introduced an integrated tab in Sunstone to access [OpenNebula Systems](#) (the company behind OpenNebula, formerly C12G) professional support. In this way, support ticket management can be performed through Sunstone, avoiding disruption of work and enhancing productivity.

The screenshot shows the OpenNebula Sunstone interface. On the left is a sidebar with navigation options: Dashboard, System, Virtual Resources, Infrastructure, Marketplace, OneFlow, and Support (highlighted). The main content area is titled 'Commercial Support Requests' and includes a description of the support subscription, a list of benefits (e.g., problem diagnosis, solving unexpected problems, performance tuning), and a 'Sign in' button. Below this is a section for 'Additional Help Resources' with icons for 'Documentation' and 'Community'. A separate window titled 'Commercial Support' shows a login form with fields for 'Email' (sysadmin@opennebula.org) and 'Password', and buttons for 'Sign in' and 'Get an account'.

This tab can be disabled in the sunstone views configuration files

This tab and can be disabled in each one of the *view yaml files*.

```
enabled_tabs:
  [ . . . ]
  #- support-tab
```

5.2.4 Troubleshooting

Cannot connect to OneFlow server

The Service instances and templates tabs may show the following message:

```
Cannot connect to OneFlow server
```

You need to start the OneFlow component following this section, or disable the Service and Service Templates menu entries in the *Sunstone views yaml files*.

VNC Troubleshooting

When clicking the VNC icon, the process of starting a session begins:

- A request is made and if a VNC session is possible, Sunstone server will add the VM Host to the list of allowed vnc session targets and create a random token associated to it.
- The server responds with the session token, then a noVNC dialog pops up.
- The VNC console embedded in this dialog will try to connect to the proxy either using websockets (default) or emulating them using Flash. Only connections providing the right token will be successful. The token expires and cannot be reused.

There can be multiple reasons that may prevent noVNC from correctly connecting to the machines. Here's a checklist of common problems:

- noVNC requires Python ≥ 2.5 for the websockets proxy to work. You may also need additional modules as `python2<version>-numpy`.
- You can retrieve useful information from `/var/log/one/novnc.log`
- You must have a GRAPHICS section in the VM template enabling VNC, as stated in the documentation. Make sure the attribute IP is set correctly (0.0.0.0 to allow connections from everywhere), otherwise, no connections will be allowed from the outside.
- Your browser must support websockets, and have them enabled. This is the default in current Chrome and Firefox, but former versions of Firefox (i.e. 3.5) required manual activation. Otherwise Flash emulation will be used.
- Make sure there are not firewalls blocking the connections. The proxy will redirect the websocket data from the VNC proxy port to the VNC port stated in the template of the VM. The value of the proxy port is defined in `sunstone-server.conf`.
- Make sure that you can connect directly from Sunstone frontend to the VM using a normal VNC client tools such as `vncviewer`.

- When using secure websockets, make sure that your certificate and key (if not included in certificate) are correctly set in Sunstone configuration files. Note that your certificate must be valid and trusted for the wss connection to work. If you are working with a certificate that it is not accepted by the browser, you can manually add it to the browser trust-list visiting `https://sunstone.server.address:vnc_proxy_port`. The browser will warn that the certificate is not secure and prompt you to manually trust it.
- If your connection is very, very, very slow, there might be a token expiration issue. Please try the manual proxy launch as described below to check it.
- Doesn't work yet? Try launching Sunstone, killing the websocketify proxy and relaunching the proxy manually in a console window with the command that is logged at the beginning of `/var/log/one/novnc.log`. You must generate a lock file containing the PID of the python process in `/var/lock/one/.novnc.lock`. Leave it running and click on the VNC icon on Sunstone for the same VM again. You should see some output from the proxy in the console and hopefully the cause of why the connection does not work.
- Please contact the support forum only when you have gone through the suggestion above and provide full sunstone logs, shown errors and any relevant information of your infrastructure (if there are Firewalls etc)
- The message "SecurityError: The operation is insecure." is usually related to a Same-Origin-Policy problem. If you have Sunstone TLS secured and try to connect to an insecure websocket for VNC, Firefox blocks that. For Firefox, you need to have both connections secured to not get this error. And don't use a self-signed certificate for the server, this would raise the error again (you can setup your own little CA, that works, but don't use a self-signed server certificate). The other option would be to go into the Firefox config (`about:config`) and set "network.websocket.allowInsecureFromHTTPS" to "true".

5.2.5 Tuning & Extending

Internationalization and Languages

Sunstone supports multiple languages. If you want to contribute a new language, make corrections or complete a translation, you can visit our:

- [Transifex project page](#)

Translating through Transifex is easy and quick. All translations should be submitted via Transifex.

Users can update or contribute translations anytime. Prior to every release, normally after the beta release, a call for translations will be made in the forum. Then the source strings will be updated in Transifex so all the translations can be updated to the latest OpenNebula version. Translation with an acceptable level of completeness will be added to the final OpenNebula release.

Customize the VM Logos

The VM Templates have an image logo to identify the guest OS. To modify the list of available logos, or to add new ones, edit `/etc/one/sunstone-logos.yaml`.

```
- { 'name': "Arch Linux",      'path': "images/logos/arch.png" }
- { 'name': "CentOS",        'path': "images/logos/centos.png" }
- { 'name': "Debian",        'path': "images/logos/debian.png" }
- { 'name': "Fedora",        'path': "images/logos/fedora.png" }
- { 'name': "Linux",         'path': "images/logos/linux.png" }
- { 'name': "Redhat",        'path': "images/logos/redhat.png" }
- { 'name': "Ubuntu",        'path': "images/logos/ubuntu.png" }
- { 'name': "Windows XP/2003", 'path': "images/logos/windowsxp.png" }
- { 'name': "Windows 8",     'path': "images/logos/windows8.png" }
```

Create VM Template

Branding the Sunstone Portal

You can easily add your logos to the login and main screens by updating the `logo:` attribute as follows:

- The login screen is defined in the `/etc/one/sunstone-views.yaml`.
- The logo of the main UI screen is defined for each view in *the view yaml file*.

sunstone-views.yaml

OpenNebula Sunstone can be adapted to different user roles. For example, it will only show the resources the users have access to. Its behavior can be customized and extended via *views*.

The preferred method to select which views are available to each group is to update the group configuration from Sunstone; as described in *Sunstone Views section*. There is also the `/etc/one/sunstone-views.yaml` file that defines an alternative method to set the view for each user or group.

Sunstone will calculate the views available to each user using:

- From all the groups the user belongs to, the views defined inside each group are combined and presented to the user
- If no views are available from the user's group, the defaults would be fetched from `/etc/one/sunstone-views.yaml`. Here, views can be defined for:
 - Each user (`users:` section), list each user and the set of views available for her.
 - Each group (`groups:` section), list the set of views for the group.
 - The default view, if a user is not listed in the `users:` section, nor its group in the `groups:` section, the default views will be used.
 - The default views for group admins, if a group admin user is not listed in the `users:` section, nor its group in the `groups:` section, the `default_groupadmin` views will be used.

By default users in the `oneadmin` group have access to all views, and users in the `users` group can use the `cloud` view.

The following `/etc/one/sunstone-views.yaml` example enables the user (`user.yaml`) and the cloud (`cloud.yaml`) views for helen and the cloud (`cloud.yaml`) view for group `cloud-users`. If more than one view is available for a given user the first one is the default.

```

---
logo: images/opennebula-sunstone-v4.0.png
users:
  helen:
    - cloud
    - user
groups:
  cloud-users:
    - cloud
default:
  - user
default_groupadmin:
  - groupadmin
  - cloud

```

A Different Endpoint for Each View

OpenNebula *Sunstone views* can be adapted to deploy a different endpoint for each kind of user. For example if you want an endpoint for the admins and a different one for the cloud users. You will just have to deploy a *new sunstone server* and set a default view for each sunstone instance:

```

# Admin sunstone
cat /etc/one/sunstone-server.conf
...
:host: admin.sunstone.com
...

cat /etc/one/sunstone-views.yaml
...
users:
groups:
default:
  - admin

```

```

# Users sunstone
cat /etc/one/sunstone-server.conf
...
:host: user.sunstone.com
...

cat /etc/one/sunstone-views.yaml
...
users:
groups:
default:
  - user

```

5.3 Sunstone Views

The OpenNebula Sunstone Views can be grouped into two different layouts. On one hand, the classic Sunstone layout exposes a complete view of the cloud, allowing administrators and advanced users to have full control of any physical or virtual resource of the cloud. On the other hand, the cloud layout exposes a simplified version of the cloud where end-users will be able to manage any virtual resource of the cloud, without taking care of the physical resources management.

Using the OpenNebula Sunstone Views you will be able to provide a simplified UI aimed at end-users of an OpenNebula cloud. The OpenNebula Sunstone Views are fully customizable, so you can easily enable or disable specific information tabs or action buttons. *You can define multiple views for different user groups.* You can define multiple views for different user groups. Each view defines a set of UI components so each user just accesses and views the relevant parts of the cloud for her role. Default views:

- *Admin View.*
- *Group Admin View.*
- *Cloud View.*
- *User View.*

These views are in 3 directories **kvm**, **vcenter** and **mixed** that Opennebula proposes by default:

- `/etc/one/sunstone-views/kvm` for KVM hypervisor.
- `/etc/one/sunstone-views/vcenter` for vCenter hypervisor.
- `/etc/one/sunstone-views/mixed` to manage both hypervisors in the same view.

To choose the views you just have to change the configuration parameter **mode** in `sunstone-server.conf`.

```
# Default views directory
:mode: 'mixed'
```

The **mixed** directory includes the views explained above with all the functionality of KVM and vCenter together.

5.3.1 Default Views

Admin View

This view provides full control of the cloud. Details can be configured in the `/etc/one/sunstone-views/*/admin.yaml` file.

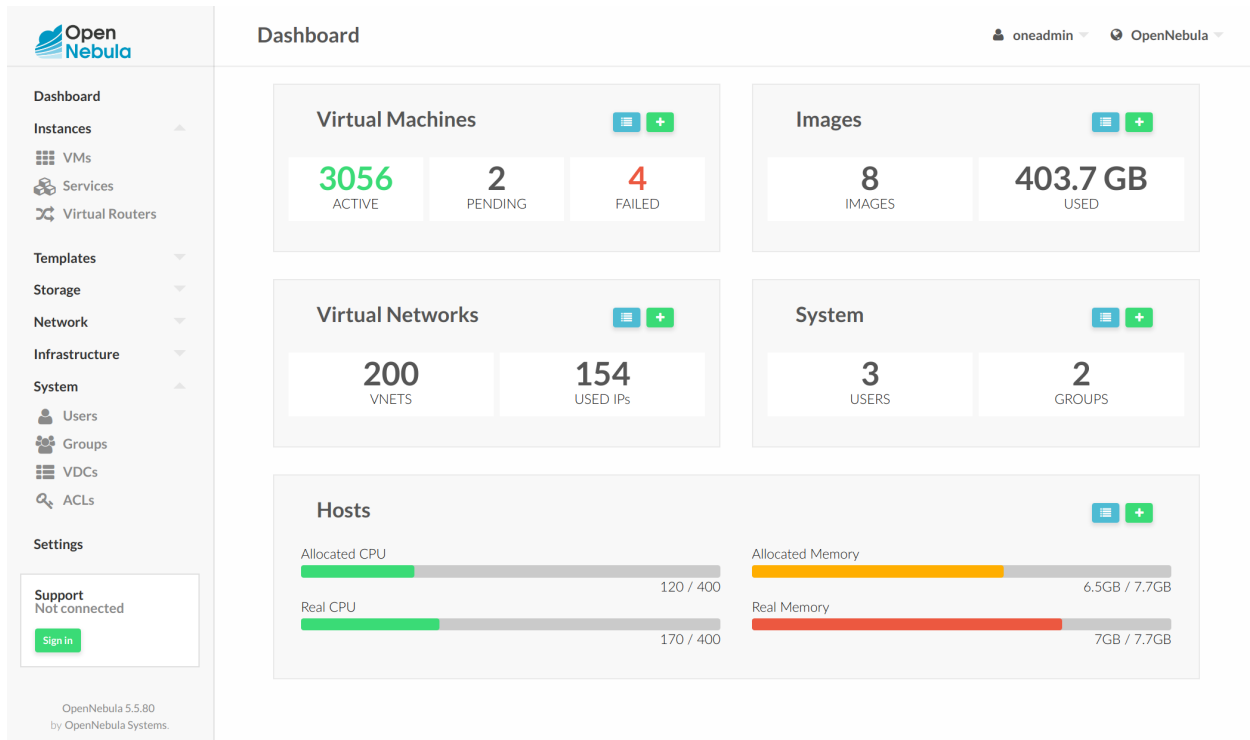

Group Admin View

Based on the Admin View. It provides control of all the resources belonging to a group, but with no access to resources outside that group, that is, restricted to the physical and virtual resources of the group. This view features the ability to create new users within the group as well as set and keep track of user quotas. For more information on how to configure this scenario see this section

Cloud View

This is a simplified view mainly intended for end-users that just require a portal where they can provision new virtual machines easily from pre-defined Templates. For more information about this view, please check the `/etc/one/sunstone-views/*/cloud.yaml` file.

In this scenario the cloud administrator must prepare a set of templates and images and make them available to the cloud users. These Templates must be ready to be instantiated. Before using them, users can optionally customize the VM capacity, add new network interfaces and provide values required by the template. Thereby, the user doesn't have to know any details of the infrastructure such as networking or storage. For more information on how to configure this scenario see this section

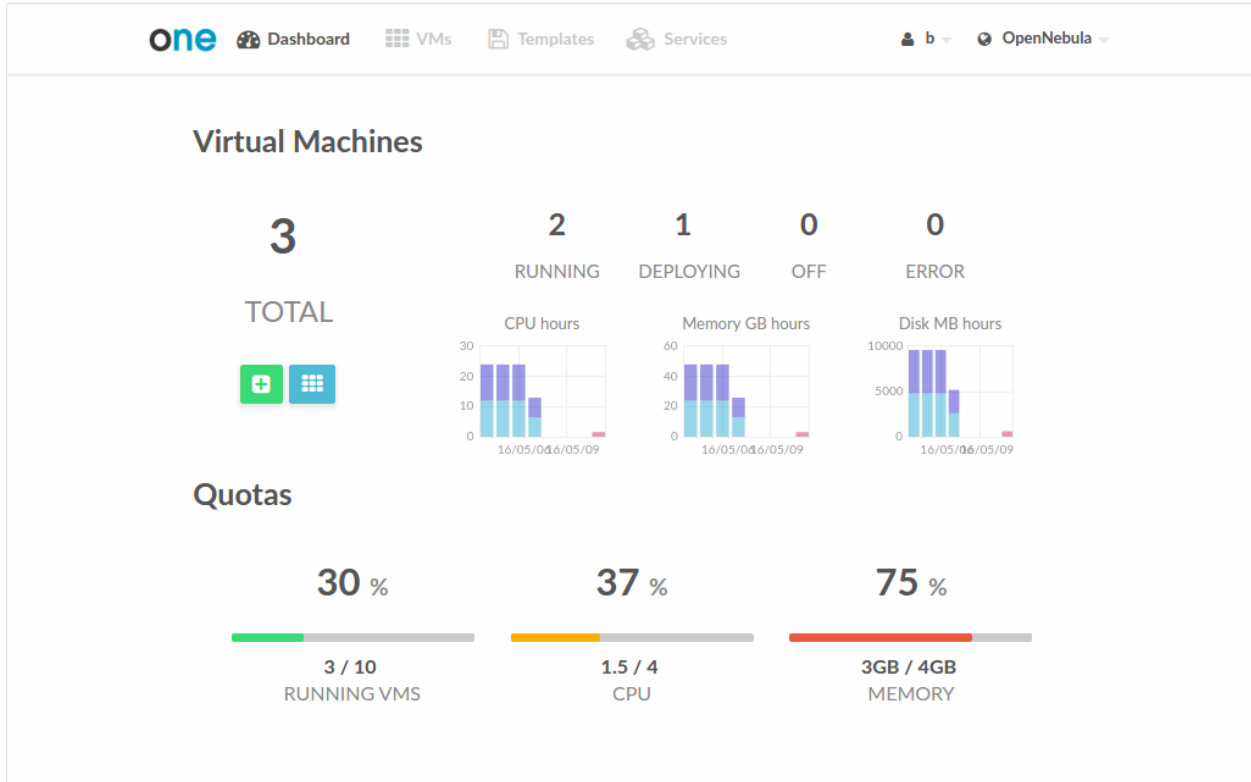

User View

Based on the Admin View, it is an advanced user view. It is intended for users that need access to more actions than the limited set available in the cloud view. Users will not be able to manage nor retrieve the hosts and clusters of the cloud. They will be able to see Datastores and Virtual Networks in order to use them when creating a new Image or Virtual Machine, but they will not be able to create new ones. Details can be configured in the `/etc/one/sunstone-views/*/user.yaml` file.

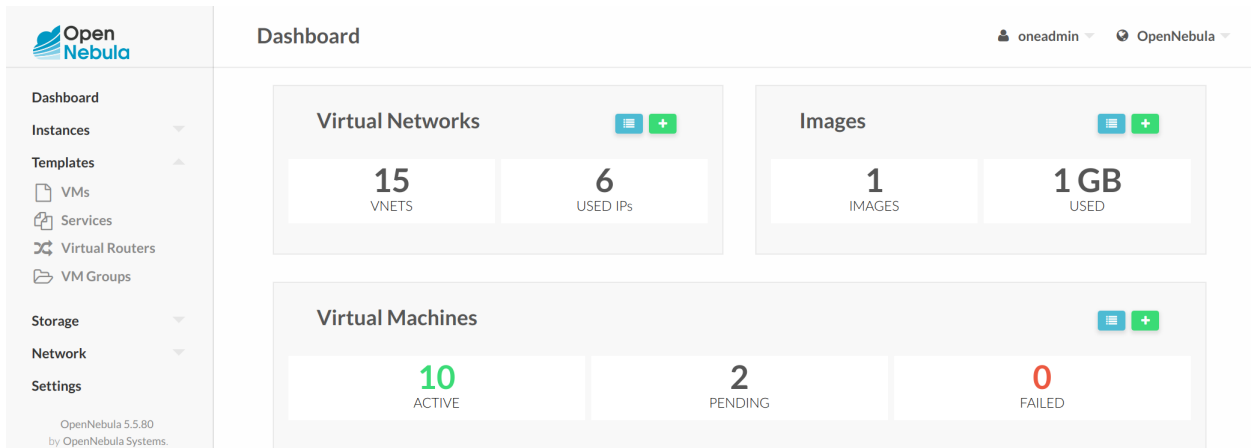

5.3.2 Configuring Access to the Views

By default, the admin view is only available to the `oneadmin` group. New users will be included in the `users` group and will use the default `cloud` view. The views assigned to a given group can be defined in the group creation

form or updating an existing group to implement different OpenNebula models. For more information on the different OpenNebula models please check the *Understanding OpenNebula documentation*.

5.3.3 Usage

Sunstone users can change their current view from the top-right drop-down menu:

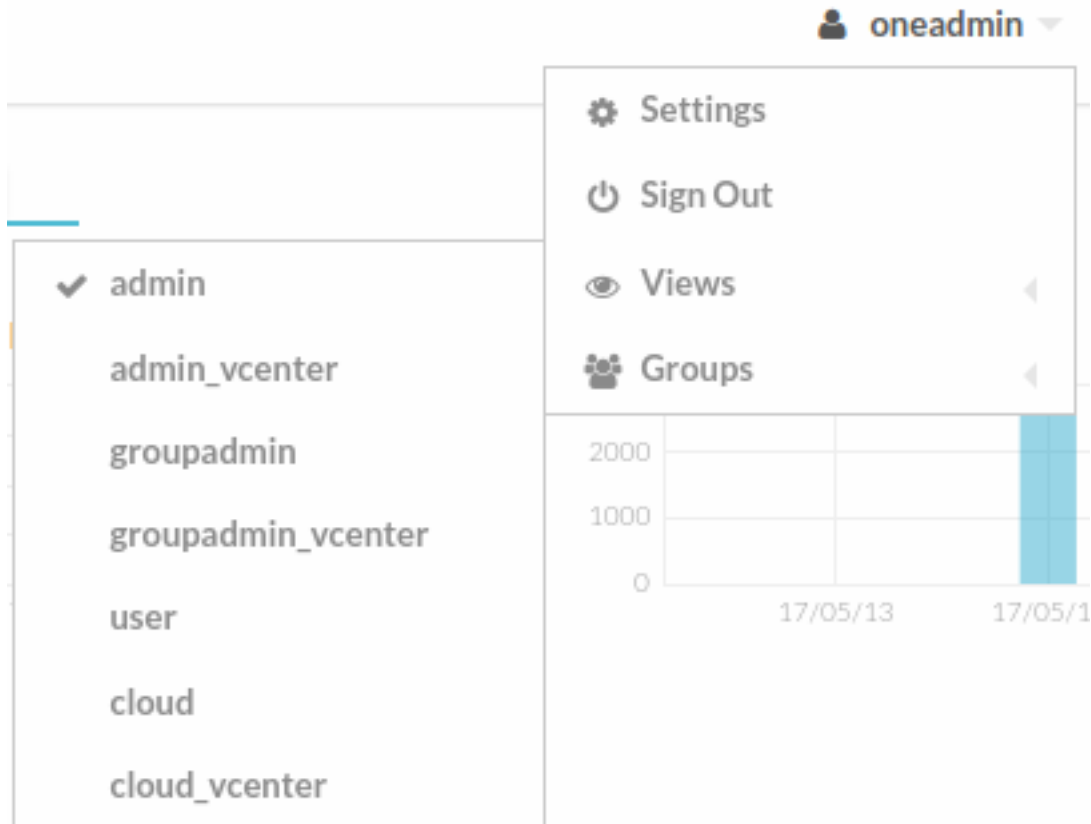

They can also configure several options from the settings tab:

- Views: change between the different available views
- Language: select the language that they want to use for the UI.
- Use secure websockets for VNC: Try to connect using secure websockets when starting VNC sessions.
- Display Name: If the user wishes to customize the username that is shown in Sunstone it is possible to do so by adding a special parameter named `SUNSTONE/DISPLAY_NAME` with the desired value. It is worth noting that Cloud Administrators may want to automate this with a hook on user create in order to fetch the user name from outside OpenNebula.

These options are saved in the user template, as well as other hidden settings like for instance the attribute that lets Sunstone remember the number of items displayed in the datatables per user. If not defined, defaults from `/etc/one/sunstone-server.conf` are taken.

The screenshot shows the OpenNebula Settings interface for the 'oneadmin' user. The left sidebar contains navigation options: Dashboard, Instances, Templates, Storage, Network, Infrastructure, System, and Settings. A 'Support Not connected' notification is visible. The main content area is titled 'Settings' and includes tabs for Info, Quotas, Group Quotas, Accounting, and Showback. The 'Info' tab is active, displaying a table of user information:

Information		Public SSH Key
ID	0	You can provide a SSH Key for this User clicking on the edit button
Name	oneadmin	
Group	oneadmin	edit
Authentication driver	core	
Password	Update password	
Table Order	-	edit
Language	-	edit
View	-	edit

Below the information table is the 'Attributes' section, showing a table with one attribute:

Attributes	
TOKEN_PASSWORD	25dd91fd23ea02a4918543ae388148d80b54aaa2 edit copy

At the bottom of the attributes section, there are two empty input fields and an 'Add' button.

5.4 Labels

The screenshot shows the 'Edit Labels' dialog box. At the top, there are two buttons: a grey one with a tag icon and a red one with a trash icon. The dialog title is 'Edit Labels'. Below the title, there is a list of labels:

- label
- linux
- label_persis

Each label has a green lock icon to its left. At the bottom of the dialog, there is a text input field containing the text 'label/fedora'.

Labels can be defined for most of the OpenNebula resources from the admin view. Each resource will store the labels information in its own template, thus it can be easily edited from the CLI or Sunstone. This feature enables the possibility to group the different resources under a given label and filter them in the admin and cloud views. The user will be able to easily find the template she wants to instantiate or select a set of resources to apply a given action.

The screenshot shows the OpenNebula web interface. On the left is a navigation menu with categories: Dashboard, Instances (with sub-items VMs, default, label, label_persis), Services (with sub-item Virtual Routers), Templates, Storage, Network, Infrastructure, System, and Settings. The main area displays a table of instances with columns for ID, Name, Owner, and Group. A single instance is listed: ID 0, Name ttylinux - kvm-0, Owner oneadmin, Group oneadmin. Below the table, it shows 'Showing 1 to 1 of 1 entries' and summary statistics: '1 TOTAL 0 ACTIVE 1 OFF'. An 'Edit Labels' modal window is open, showing a list of labels: 'label' and 'label_persis'. Under 'System Labels', there are checkboxes for 'default' (checked) and 'oneadmin' (unchecked). A text input field labeled 'Add Label' is at the bottom of the modal. To the right of the modal, there is a search bar and a pagination control showing 'previous 1 Next'.

The list of labels defined for each pool will be shown in the left navigation menu. After clicking on one of these labels only the resources with this label will be shown in the table. This filter is also available in the cloud view inside the virtual machine creation form to easily select a specific template.

To create a label hierarchy, use the '/' character. For example, you could have the labels 'Linux/Ubuntu' and 'Linux/CentOS'. Please note that a resource with the label 'Linux/Ubuntu' is not automatically added to the parent 'Linux' label, but you can do it explicitly.

5.4.1 Persistent Labels

You can also create persistent labels, these types of labels will not be deleted even when they have no associated resources. To define the persistent tags we have 2 options, defining them as system tags, including them in the file `/etc/one/sunstone-views.yaml` or adding them to the user's template, this second form can be done through the CLI or through the sunstone interface, doing Click on padlock already created tags.

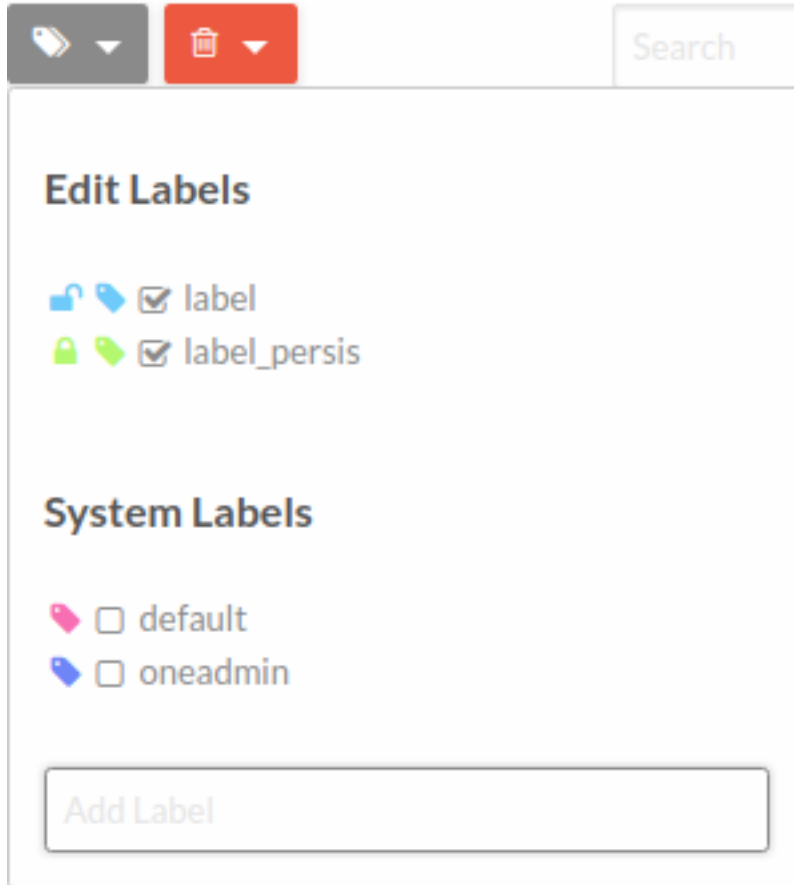

User Labels

This labels will be saved in the user's template when the user do click on padlock, this labels are easily editable from the CLI or Sunstone interface. And the following template when you save a label in the user's template

```
TEMPLATE = [
  LABELS = "labels_persis,label_persis_2"
]
```

System Labels

These labels are defined in `/etc/one/sunstone-views.yaml`, you can separate them per groups of users or introduce them into default section.

```
logo: images/opennebula-5.0.png
groups:
  oneadmin:
    - admin
    - admin_vcenter
    - groupadmin
    - groupadmin_vcenter
    - user
    - cloud
    - cloud_vcenter
```

(continues on next page)

(continued from previous page)

```

default:
  - cloud
default_groupadmin:
  - groupadmin
  - cloud
labels_groups:
  oneadmin:
    - oneadmin
  default:
    - default

```

5.4.2 Defining a New OpenNebula Sunstone View or Customizing an Existing one

View definitions are placed in the `/etc/one/sunstone-views/*` directory. Each view is defined by a configuration file, in the form:

```
<view_name>.yaml
```

The name of the view will be the filename without the yaml extension.

```

/etc/one/
...
|-- sunstone-views/
|   |-- mixed/
|   |   |-- admin.yaml      <--- the admin view
|   |   |-- cloud.yaml     <--- the cloud view
|   |-- kvm/
|   |   |-- admin.yaml     <--- the admin view
|   |   |-- cloud.yaml     <--- the cloud view
|   |-- vcenter/
|   |   |-- admin.yaml     <--- the admin view
|   |   |-- cloud.yaml     <--- the cloud view
`-- sunstone-views.yaml
...

```

Note: The easiest way to create a custom view is to copy the `admin.yaml` or `cloud.yaml` file and then harden it as needed.

Admin View Customization

The contents of a view file specifies the logos, links, confirm actions, group filter, enabled features, visible tabs, and enabled actions.

- *small_logo*: Image path to customize the Sunstone logo in admin views. By default OpenNebula logo.
- *provision_logo*: Image path to customize the Sunstone logo in user views. By default OpenNebula logo.
- *link_logo*: External URL below the logo.
- *text_link_logo*: Text link for `link_logo`.
- *confirm_vms*: If true, the user will need to confirm the actions on a VM.
- *filter_view*: If false, hides the group name by which it's filtering.

For the dashboard, the following widgets can be configured:

```
# The following widgets can be used inside any of the '_per_row' settings
# below. As the name suggest, the widgets will be scaled to fit one,
# two, or three per row. The footer uses the widgets at full size, i.e.
# one per row.
#
# - storage
# - users
# - network
# - hosts
# - vms
# - groupquotas
# - quotas
panel_tabs:
actions:
    Dashboard.refresh: false
    Sunstone.toggle_top: false
widgets_one_per_row:
    - hosts
widgets_three_per_row:
widgets_two_per_row:
    - vms
    - users
    - storage
    - network
widgets_one_footer:
```

Inside features there are twelve settings:

- **showback**: When this is false, all Showback features are hidden. The monthly report tables, and the cost for new VMs in the create VM wizard.
- **secgroups**: If true, the create VM wizard will allow to add security groups to each network interface.
- **instantiate_hide_cpu**: If true, hide the CPU setting in the VM creation dialog.
- **instantiate_cpu_factor**: False to not scale the CPU from VCPU. Number [0, 1] to scale.
- **instantiate_persistent**: True to show the option to make an instance persistent.
- **vcenter_vm_folder**: True to show an input to specify the the VMs and Template path/folder where a vCenter VM will be deployed to.
- **show_ds_instantiate**: True to show the datastore datatable to instantiate VM.
- **show_vmgroup_instantiate**: True to show the vmgroup datatable to instantiate VM.
- **show_vnet_instantiate**: True to show the vnet datatable to instantiate VM.
- **show_host_instantiate**: True to show the host datatable to instantiate VM.
- **show_monitoring_info**: True to show the monitoring info (VM & VRouters).
- **show_attributes_info**: True to show the attributes info (VM & VRouters).
- **resize_enforce**: If set to True, the host capacity will be checked. This will only affect oneadmin requests, regular users resize requests will always be enforced.
- **deploy_enforce**: If set to True, the host capacity will be checked. This will only affect oneadmin requests, regular users resize requests will always be enforced.
- **migrate_enforce**: If set to True, the host capacity will be checked. This will only affect oneadmin requests, regular users resize requests will always be enforced.

```

features:
  # True to show showback monthly reports, and VM cost
  showback: true

  # Allows to change the security groups for each network interface
  # on the VM creation dialog
  secgroups: true

```

This file also defines the tabs available in the view (note: tab is one of the main sections of the UI, those in the left-side menu). Each tab can be enabled or disabled by updating the `enabled_tabs` attribute. For example to disable the Clusters tab, comment the `clusters-tab` entry:

```

enabled_tabs:
  - dashboard-tab
  - instances-top-tab
  - vms-tab
  - oneflow-services-tab
  - templates-top-tab
  - templates-tab
  - oneflow-templates-tab
  - storage-top-tab
  - datastores-tab
  - images-tab
  - files-tab
  - marketplaces-tab
  - marketplaceapps-tab
  - network-top-tab
  - vnets-tab
  - vrouters-tab
  - vnets-topology-tab
  - secgroups-tab
  - infrastructure-top-tab
  #- clusters-tab
  - hosts-tab
  - zones-tab
  - system-top-tab
  - users-tab
  - groups-tab
  - vdc-tab
  - acls-tab
  - settings-tab
  - support-tab

```

Each tab can be tuned by selecting:

- The individual resource tabs available (`panel_tabs` attribute) in the tab, these are the tabs activated when an object is selected (e.g. the information, or capacity tabs in the Virtual Machines tab).
- The columns shown in the main information table (`table_columns` attribute).
- The action buttons available to the view (`actions` attribute).

The attributes in each of the above sections should be self-explanatory. As an example, the following section defines a simplified datastore tab, without the info panel tab and no action buttons:

```

datastores-tab:
  panel_tabs:
    datastore_info_tab: false

```

(continues on next page)

(continued from previous page)

```

datastore_image_tab: true
datastore_clusters_tab: false
table_columns:
  - 0      # Checkbox
  - 1      # ID
  - 2      # Owner
  - 3      # Group
  - 4      # Name
  - 5      # Capacity
  - 6      # Cluster
  #- 7      # Basepath
  #- 8      # TM
  #- 9      # DS
  - 10     # Type
  - 11     # Status
  #- 12     # Labels
actions:
  Datastore.refresh: true
  Datastore.create_dialog: false
  Datastore.import_dialog: false
  Datastore.addtocluster: false
  Datastore.rename: false
  Datastore.chown: false
  Datastore.chgrp: false
  Datastore.chmod: false
  Datastore.delete: false
  Datastore.enable: false
  Datastore.disable: false

```

Cloud View Customization

The cloud layout can also be customized by changing the corresponding `/etc/one/sunstone-views/` yaml files. In this file you can customize the options available when instantiating a new template, the dashboard setup or the resources available for cloud users.

Features

- `showback`: When this is false, all Showback features are hidden. The monthly report tables, and the cost for new VMs in the create VM wizard.
- `secgroups`: If true, the create VM wizard will allow to add security groups to each network interface.
- `instantiate_hide_cpu`: If true, hide the CPU setting in the VM creation dialog.
- `instantiate_cpu_factor`: False to not scale the CPU from VCPU. Number [0, 1] to scale.
- `instantiate_persistent`: True to show the option to make an instance persistent.
- `cloud_vm_create`: True to allow to create machines to cloud users.
- `show_monitoring_info`: True to show the monitoring info (VM & VRouters).
- `show_attributes_info`: True to show the attributes info (VM & VRouters).
- `show_attach_disk_advanced`: True to show advanced options in attach disk dialog.
- `show_attach_nic_advanced`: True to show advanced options in attach nic dialog.

```
features:
  # True to show showback monthly reports, and VM cost
  showback: true

  # Allows to change the security groups for each network interface
  # on the VM creation dialog
  secgroups: true
```

Resources

The list of VMs is always visible. The list of VM Templates and OneFlow Services can be hidden with the `provision_tabs` setting.

```
tabs:
  provision-tab:
    provision_tabs:
      flows: true
      templates: true
```

Dashboard

The dashboard can be configured to show user's quotas, group quotas, overview of user VMs, overview of group VMs

```
tabs:
  dashboard:
    # Connected user's quotas
    quotas: true
    # Overview of connected user's VMs
    vms: true
    # Group's quotas
    vdcquotas: false
    # Overview of group's VMs
    vdcvms: false
```

Create VM Wizard

The create VM wizard can be configured with the following options:

```
tabs:
  create_vm:
    # True to allow capacity (CPU, MEMORY, VCPU) customization
    capacity_select: true
    # True to allow NIC customization
    network_select: true
    # True to allow DISK size customization
    disk_resize: true
```

Actions

The actions available for a given VM can be customized and extended by modifying the yaml file. You can even insert VM panels from the admin view into this view, for example to use the disk snapshots or scheduled actions.

- Hiding the delete button

```
tabs:
  provision-tab:
    ...
    actions: &provisionactions
    ...
    VM.shutdown_hard: false
    VM.delete: false
```

- Using undeploy instead of power off

```
tabs:
  provision-tab:
    ...
    actions: &provisionactions
    ...
    VM.poweroff: false
    VM.poweroff_hard: false
    VM.undeploy: true
    VM.undeploy_hard: true
```

- Adding panels from the admin view, for example the disk snapshots tab

```
tabs:
  provision-tab:
    panel_tabs:
      ...
      vm_snapshot_tab: true
      ...
    ...
    actions: &provisionactions
    ...
    VM.disk_snapshot_create: true
    VM.disk_snapshot_revert: true
    VM.disk_snapshot_delete: true
```

one oneadmin OpenNebula

VMs Templates Services

ttylinux virtio-35 Refresh Back

📄 🔄 🔌 🗑️

🟢 RUNNING

📄 x0.1 - 128MB - ttylinux-vd

🌐 --

👤 oneadmin ⌚ 21h ago - ID: 35

Storage Actions

ID	Target	Image / Format-Size	Size	Persistent	Actions
0	vda	ttylinux-vd	27MB/24MB	YES	↩️ Revert ✖ Delete

- 0 16:02:15 02/10/2015 -/24MB Updated packages
 - 1 16:02:37 02/10/2015 -/24MB Release Candidate

Autorefresh

VM autorefresh time (ms) of individual VM view. By default at 10 seconds. You must add the following line in `vms-tab` in the different views:

```
actions:
  VM.refresh: true
  ...
  VM.menu_labels: true
autorefresh_info: 5000 # ms
```

5.5 User Security and Authentication

By default Sunstone works with the core authentication method (user and password) although you can configure any authentication mechanism supported by OpenNebula. In this section you will learn how to enable other authentication methods and how to secure the Sunstone connections through SSL.

5.5.1 Authentication Methods

Authentication is two-folded:

- **Web client and Sunstone server.** Authentication is based on the credentials stored in the OpenNebula database for the user. Depending on the type of this credentials the authentication method can be: sunstone, x509 and opennebula (supporting LDAP or other custom methods).

- **Sunstone server and OpenNebula core.** The requests of a user are forwarded to the core daemon, including the original user name. Each request is signed with the credentials of a special `server` user. This authentication mechanism is based either in symmetric key cryptography (default) or x509 certificates. Details on how to configure these methods can be found in the *Cloud Authentication section*.

The following sections details the client-to-Sunstone server authentication methods.

Basic Auth

In the basic mode, username and password are matched to those in OpenNebula's database in order to authorize the user at the time of login. Rack cookie-based sessions are then used to authenticate and authorize the requests.

To enable this login method, set the `:auth:` option of `/etc/one/sunstone-server.conf` to `sunstone`:

```
:auth: sunstone
```

OpenNebula Auth

Using this method the credentials included in the header will be sent to the OpenNebula core and the authentication will be delegated to the OpenNebula auth system, using the specified driver for that user. Therefore any OpenNebula auth driver can be used through this method to authenticate the user (i.e: LDAP). The sunstone configuration is:

```
:auth: opennebula
```

x509 Auth

This method performs the login to OpenNebula based on a x509 certificate DN (Distinguished Name). The DN is extracted from the certificate and matched to the password value in the user database.

The user password has to be changed running one of the following commands:

```
$ oneuser chauth new_user x509 "/C=ES/O=ONE/OU=DEV/CN=clouduser"
```

or the same command using a certificate file:

```
$ oneuser chauth new_user --x509 --cert /tmp/my_cert.pem
```

New users with this authentication method should be created as follows:

```
$ oneuser create new_user "/C=ES/O=ONE/OU=DEV/CN=clouduser" --driver x509
```

or using a certificate file:

```
$ oneuser create new_user --x509 --cert /tmp/my_cert.pem
```

To enable this login method, set the `:auth:` option of `/etc/one/sunstone-server.conf` to `x509`:

```
:auth: x509
```

The login screen will not display the username and password fields anymore, as all information is fetched from the user certificate:



Note that OpenNebula will not verify that the user is holding a valid certificate at the time of login: this is expected to be done by the external container of the Sunstone server (normally Apache), whose job is to tell the user's browser that the site requires a user certificate and to check that the certificate is consistently signed by the chosen Certificate Authority (CA).

Warning: Sunstone x509 auth method only handles the authentication of the user at the time of login. Authentication of the user certificate is a complementary setup, which can rely on Apache.

Remote Auth

This method is similar to x509 auth. It performs the login to OpenNebula based on a Kerberos `REMOTE_USER`. The `USER@DOMAIN` is extracted from `REMOTE_USER` variable and matched to the password value in the user database. To use Kerberos authentication users needs to be configured with the public driver. Note that this will prevent users to authenticate through the XML-RPC interface, only Sunstone access will be granted to these users.

To update existing users to use the Kerberos authentication change the driver to public and update the password as follows:

```
$ oneuser chauth new_user public "new_user@DOMAIN"
```

New users with this authentication method should be created as follows:

```
$ oneuser create new_user "new_user@DOMAIN" --driver public
```

To enable this login method, set the `:auth:` option of `/etc/one/sunstone-server.conf` to `remote`:

```
:auth: remote
```

The login screen will not display the username and password fields anymore, as all information is fetched from Kerberos server or a remote authentication service.

Note that OpenNebula will not verify that the user is holding a valid Kerberos ticket at the time of login: this is expected to be done by the external container of the Sunstone server (normally Apache), whose job is to tell the user's browser that the site requires a valid ticket to login.

Warning: Sunstone remote auth method only handles the authentication of the user at the time of login. Authentication of the remote ticket is a complementary setup, which can rely on Apache.

5.5.2 Configuring a SSL Proxy

OpenNebula Sunstone runs natively just on normal HTTP connections. If the extra security provided by SSL is needed, a proxy can be set up to handle the SSL connection that forwards the petition to the Sunstone server and takes back the answer to the client.

This set up needs:

- A server certificate for the SSL connections
- An HTTP proxy that understands SSL
- OpenNebula Sunstone configuration to accept petitions from the proxy

If you want to try out the SSL setup easily, you can find in the following lines an example to set a self-signed certificate to be used by a web server configured to act as an HTTP proxy to a correctly configured OpenNebula Sunstone.

Let's assume the server where the proxy is going to be started is called `cloudserver.org`. Therefore, the steps are:

Step 1: Server Certificate (Snakeoil)

We are going to generate a snakeoil certificate. If using an Ubuntu system follow the next steps (otherwise your mileage may vary, but not a lot):

- Install the `ssl-cert` package

```
# apt-get install ssl-cert
```

- Generate the certificate

```
# /usr/sbin/make-ssl-cert generate-default-snakeoil
```

- As we are using `lighttpd`, we need to append the private key with the certificate to obtain a server certificate valid to `lighttpd`

```
# cat /etc/ssl/private/ssl-cert-snakeoil.key /etc/ssl/certs/ssl-cert-snakeoil.pem > /
↳ etc/lighttpd/server.pem
```

Step 2: SSL HTTP Proxy

lighttpd

You will need to edit the `/etc/lighttpd/lighttpd.conf` configuration file and

- Add the following modules (if not present already)
 - `mod_access`
 - `mod_alias`
 - `mod_proxy`
 - `mod_accesslog`
 - `mod_compress`
- Change the server port to 443 if you are going to run `lighttpd` as root, or any number above 1024 otherwise:

```
server.port                = 8443
```

- Add the proxy module section:

```
#### proxy module
## read proxy.txt for more info
proxy.server              = ( "" =>
                            ("" =>
                              (
                                "host" => "127.0.0.1",
                                "port" => 9869
                              )
                            )
                          )

#### SSL engine
ssl.engine                = "enable"
ssl.pemfile               = "/etc/lighttpd/server.pem"
```

The host must be the server hostname of the computer running the Sunstone server, and the port the one that the Sunstone Server is running on.

nginx

You will need to configure a new virtual host in `nginx`. Depending on the operating system and the method of installation, `nginx` loads virtual host configurations from either `/etc/nginx/conf.d` or `/etc/nginx/sites-enabled`.

- A sample `cloudserver.org` virtual host is presented next:

```
#### OpenNebula Sunstone upstream
upstream sunstone {
    server 127.0.0.1:9869;
}

#### cloudserver.org HTTP virtual host
server {
```

(continues on next page)

(continued from previous page)

```

listen 80;
server_name cloudserver.org;

### Permanent redirect to HTTPS (optional)
return 301 https://$server_name:8443;
}

#### cloudserver.org HTTPS virtual host
server {
    listen 8443;
    server_name cloudserver.org;

    ### SSL Parameters
    ssl on;
    ssl_certificate /etc/ssl/certs/ssl-cert-snakeoil.pem;
    ssl_certificate_key /etc/ssl/private/ssl-cert-snakeoil.key;

    ### Proxy requests to upstream
    location / {
        proxy_pass http://sunstone;
    }
}

```

The IP address and port number used in `upstream` must be the one of the server Sunstone is running on. On typical installations the nginx master process is run as user `root` so you don't need to modify the HTTPS port.

Step 3: Sunstone Configuration

Edit `/etc/one/sunstone-server.conf` to listen at `localhost:9869`.

```

:host: 127.0.0.1
:port: 9869

```

Once the proxy server is started, OpenNebula Sunstone requests using HTTPS URIs can be directed to `https://cloudserver.org:8443`, that will then be unencrypted, passed to `localhost`, port 9869, satisfied (hopefully), encrypted again and then passed back to the client.

Note: To change `serveradmin` password, follow the next steps:

```

#oneuser passwd 1 --sha1 <PASSWORD>
#echo 'serveradmin:PASSWORD' > /var/lib/one/.one/oneflow_auth
#echo 'serveradmin:PASSWORD' > /var/lib/one/.one/ec2_auth
#echo 'serveradmin:PASSWORD' > /var/lib/one/.one/onegate_auth
#echo 'serveradmin:PASSWORD' > /var/lib/one/.one/occi_auth
#echo 'serveradmin:PASSWORD' > /var/lib/one/.one/sunstone_auth

```

Restart Sunstone after changing the password.

5.6 Cloud Servers Authentication

OpenNebula ships with two servers: *Sunstone* and EC2. When a user interacts with one of them, the server authenticates the request and then forwards the requested operation to the OpenNebula daemon.

The forwarded requests between the servers and the core daemon include the original user name, and are signed with the credentials of an special `server` user.

In this guide this request forwarding mechanism is explained, and how it is secured with a symmetric-key algorithm or x509 certificates.

5.6.1 Server Users

The *Sunstone* and EC2 services communicate with the core using a `server` user. OpenNebula creates the **serveradmin** account at bootstrap, with the authentication driver **server_cipher** (symmetric key).

This `server` user uses a special authentication mechanism that allows the servers to perform an operation on behalf of other user.

You can strengthen the security of the requests from the servers to the core daemon changing the serveruser's driver to **server_x509**. This is specially relevant if you are running your server in a machine other than the frontend.

Please note that you can have as many users with a **server_*** driver as you need. For example, you may want to have Sunstone configured with a user with **server_x509** driver, and EC2 with **server_cipher**.

5.6.2 Symmetric Key

Enable

This mechanism is enabled by default, you will have a user named **serveradmin** with driver **server_cipher**.

To use it, you need a user with the driver **server_cipher**. Enable it in the relevant configuration file in `/etc/one`:

- *Sunstone*: `/etc/one/sunstone-server.conf`
- EC2: `/etc/one/econe.conf`

```
:core_auth: cipher
```

Configure

You must update the configuration files in `/var/lib/one/.one` if you change the `serveradmin`'s password, or create a different user with the **server_cipher** driver.

```
$ ls -l /var/lib/one/.one
ec2_auth
sunstone_auth

$ cat /var/lib/one/.one/sunstone_auth
serveradmin:1612b78a4843647a4b541346f678f9e1b43bbcf9
```

Warning: `serveradmin` password is hashed in the database. You can use the `--sha1` flag when issuing `oneuser passwd` command for this user.

Warning: When Sunstone is running in a different machine than `oned` you should use an SSL connection. This can be archived with an SSL proxy like `stunnel` or `apache/nginx` acting as proxy. After securing OpenNebula XMLRPC connection configure Sunstone to use `https` with the proxy port:

```
:one_xmlrpc: https://frontend:2634/RPC2
```

5.6.3 x509 Encryption

Enable

To enable it, change the authentication driver of the **serveradmin** user, or create a new user with the driver **server_x509**:

```
$ oneuser chauth serveradmin server_x509
$ oneuser passwd serveradmin --x509 --cert usercert.pem
```

The serveradmin account should look like:

```
$ oneuser list

  ID GROUP      NAME              AUTH
↪PASSWORD
  0 oneadmin oneadmin      core
↪c24783ba96a35464632a624d9f829136edc0175e
  1 oneadmin serveradmin  server_x          /C=ES/O=ONE/OU=DEV/
↪CN=server
```

You need to edit `/etc/one/auth/server_x509_auth.conf` and uncomment all the fields. The defaults should work:

```
# User to be used for x509 server authentication
:srv_user: serveradmin

# Path to the certificate used by the OpenNebula Services
# Certificates must be in PEM format
:one_cert: "/etc/one/auth/cert.pem"
:one_key:  "/etc/one/auth/pk.pem"
```

Copy the certificate and the private key to the paths set in `:one_cert:` and `:one_key:`, or simply update the paths.

Then edit the relevant configuration file in `/etc/one`:

- **Sunstone**: `/etc/one/sunstone-server.conf`
- **EC2**: `/etc/one/econe.conf`

```
:core_auth: x509
```

Configure

To trust the serveradmin certificate, `/etc/one/auth/cert.pem` if you used the default path, the CA's certificate must be added to the `ca_dir` defined in `/etc/one/auth/x509_auth.conf`. See the [x509 Authentication guide for more information](#).

```
$ openssl x509 -noout -hash -in cacert.pem
78d0bbd8

$ sudo cp cacert.pem /etc/one/auth/certificates/78d0bbd8.0
```

5.6.4 Tuning & Extending

Files

You can find the drivers in these paths:

- `/var/lib/one/remotes/auth/server_cipher/authenticate`
- `/var/lib/one/remotes/auth/server_server/authenticate`

Authentication Session String

OpenNebula users with the driver **server_cipher** or **server_x509** use a special authentication session string (the first parameter of the XML-RPC calls). A regular authentication token is in the form:

```
username:secret
```

Whereas a user with a **server_*** driver must use this token format:

```
username:target_username:secret
```

The core daemon understands a request with this authentication session token as “perform this operation on behalf of `target_user`”. The `secret` part of the token is signed with one of the two mechanisms explained before.

5.7 Configuring Sunstone for Large Deployments

Low to medium enterprise clouds will typically deploy Sunstone in a single machine along with the OpenNebula daemons. However this simple deployment can be improved by:

- Isolating the access from Web clients to the Sunstone server. This can be achieved by deploying the Sunstone server in a separated machine.
- Improve the scalability of the server for large user pools. Usually deploying sunstone in a separate application container in one or more hosts.

Check also the [api scalability guide](#) as these of the tips also have an impact on Sunstone performance.

5.7.1 Deploying Sunstone in a Different Machine

By default the Sunstone server is configured to run in the frontend, but you are able to install the Sunstone server in a machine different from the frontend.

- You will need to install only the sunstone server packages in the machine that will be running the server. If you are installing from source use the `-s` option for the `install.sh` script.
- Make sure `:one_xmlrpc:` variable in `sunstone-server.conf` points to the right place where OpenNebula frontend is running, You can also leave it undefined and export `ONE_XMLRPC` environment variable.
- Provide the serveradmin credentials in the following file `/var/lib/one/.one/sunstone_auth`. If you changed the serveradmin password please check the [Cloud Servers Authentication guide](#).
- If you want to upload files to OpenNebula, you will have to share the upload directory (`/var/tmp` by default) between sunstone and oned. Some server do not take into account the `TMPDIR` env var and this directory must be defined in the configuration file, for example in Passenger (`client_body_temp_path`)

```
$ cat /var/lib/one/.one/sunstone_auth
serveradmin:1612b78a4843647a4b541346f678f9e1b43bbcf9
```

Using this setup the VirtualMachine logs will not be available. If you need to retrieve this information you must deploy the server in the frontend

5.7.2 Running Sunstone Inside Another Webserver

Self contained deployment of Sunstone (using `sunstone-server` script) is ok for small to medium installations. This is no longer true when the service has lots of concurrent users and the number of objects in the system is high (for example, more than 2000 simultaneous virtual machines).

Sunstone server was modified to be able to run as a `rack` server. This makes it suitable to run in any web server that supports this protocol. In ruby world this is the standard supported by most web servers. We now can select web servers that support spawning multiple processes like `unicorn` or embedding the service inside `apache` or `nginx` web servers using the `Passenger` module. Another benefit will be the ability to run Sunstone in several servers and balance the load between them.

Warning: Deploying Sunstone behind a proxy in a federated environment requires some specific configuration to properly handle the Sunstone headers required by the Federation.

- **nginx:** enable `underscores_in_headers on;` and `proxy_pass_request_headers on;`

Configuring memcached

When using one on these web servers the use of a `memcached` server is necessary. Sunstone needs to store user sessions so it does not ask for user/password for every action. By default Sunstone is configured to use memory sessions, that is, the sessions are stored in the process memory. Thin and webrick web servers do not spawn new processes but new threads all of them have access to that session pool. When using more than one process to server Sunstone there must be a service that stores this information and can be accessed by all the processes. In this case we will need to install `memcached`. It comes with most distributions and its default configuration should be ok. We will also need to install ruby libraries to be able to access it. The rubygem library needed is `memcache-client`. If there is no package for your distribution with this ruby library you can install it using rubygems:

```
$ sudo gem install memcache-client
```

Then you will have to change in sunstone configuration (`/etc/one/sunstone-server.conf`) the value of `:sessions` to `memcache`.

If you want to use `novnc` you need to have it running. You can start this service with the command:

```
$ novnc-server start
```

Another thing you have to take into account is the user on which the server will run. The installation sets the permissions for `oneadmin` user and group and files like the Sunstone configuration and credentials can not be read by other users. Apache usually runs as `www-data` user and group so to let the server run as this user the group of these files must be changed, for example:

```
$ chgrp www-data /etc/one/sunstone-server.conf
$ chgrp www-data /etc/one/sunstone-plugins.yaml
$ chgrp www-data /var/lib/one/.one/sunstone_auth
$ chmod a+x /var/lib/one
```

(continues on next page)

(continued from previous page)

```
$ chmod a+x /var/lib/one/.one
$ chmod a+x /var/lib/one/sunstone
$ chgrp www-data /var/log/one/sunstone*
$ chmod g+w /var/log/one/sunstone*
```

We advise to use Passenger in your installation but we will show you how to run Sunstone inside unicorn web server as an example.

For more information on web servers that support rack and more information about it you can check the [rack documentation](#) page. You can alternatively check a [list of ruby web servers](#).

Running Sunstone with Unicorn

To get more information about this web server you can go to its [web page](#). It is a multi process web server that spawns new processes to deal with requests.

The installation is done using rubygems (or with your package manager if it is available):

```
$ sudo gem install unicorn
```

In the directory where Sunstone files reside (`/usr/lib/one/sunstone` or `/usr/share/opennebula/sunstone`) there is a file called `config.ru`. This file is specific for rack applications and tells how to run the application. To start a new server using unicorn you can run this command from that directory:

```
$ unicorn -p 9869
```

Default unicorn configuration should be ok for most installations but a configuration file can be created to tune it. For example, to tell unicorn to spawn 4 processes and write `stderr` to `/tmp/unicorn.log` we can create a file called `unicorn.conf` that contains:

```
worker_processes 4
logger debug
stderr_path '/tmp/unicorn.log'
```

and start the server and daemonize it using:

```
$ unicorn -d -p 9869 -c unicorn.conf
```

You can find more information about the configuration options in the [unicorn documentation](#).

Running Sunstone with Passenger in Apache

[Phusion Passenger](#) is a module for [Apache](#) and [Nginx](#) web servers that runs ruby rack applications. This can be used to run Sunstone server and will manage all its life cycle. If you are already using one of these servers or just feel comfortable with one of them we encourage you to use this method. This kind of deployment adds better concurrency and lets us add an https endpoint.

We will provide the instructions for Apache web server but the steps will be similar for nginx following [Passenger documentation](#).

First thing you have to do is install Phusion Passenger. For this you can use pre-made packages for your distribution or follow the [installation instructions](#) from their web page. The installation is self explanatory and will guide you in all the process, follow them and you will be ready to run Sunstone.

Next thing we have to do is configure the virtual host that will run our Sunstone server. We have to point to the `public` directory from the Sunstone installation, here is an example:

```

<VirtualHost *:80>
  ServerName sunstone-server
  PassengerUser oneadmin
  # !!! Be sure to point DocumentRoot to 'public'!
  DocumentRoot /usr/lib/one/sunstone/public
  <Directory /usr/lib/one/sunstone/public>
    # This relaxes Apache security settings.
    AllowOverride all
    # MultiViews must be turned off.
    Options -MultiViews
    # Uncomment this if you're on Apache >= 2.4:
    #Require all granted
    # Comment this if you're on OpenNebula < 5.6.0:
    Options FollowSymLinks
  </Directory>
</VirtualHost>

```

Note: It's compulsory to add the `FollowSymLinks` option in the virtual host.

Note: When you're experiencing login problems you might want to set `PassengerMaxInstancesPerApp 1` in your passenger configuration or try memcached since Sunstone does not support sessions across multiple server instances.

Now the configuration should be ready, restart -or reload apache configuration- to start the application and point to the virtual host to check if everything is running.

Running Sunstone behind nginx SSL Proxy

How to set things up with nginx ssl proxy for sunstone and encrypted vnc.

```

# No squealing.
server_tokens off;

# OpenNebula Sunstone upstream
upstream sunstone {
  server 127.0.0.1:9869;
}

# HTTP virtual host, redirect to HTTPS
server {
  listen 80 default_server;
  return 301 https://$server_name:443;
}

# HTTPS virtual host, proxy to Sunstone
server {
  listen 443 ssl default_server;
  ssl_certificate /etc/ssl/certs/opennebula-certchain.pem;
  ssl_certificate_key /etc/ssl/private/opennebula-key.pem;
  ssl_stapling on;
}

```

And this is the changes that have to be made to `sunstone-server.conf`:

UI Settings

```
:vnc_proxy_port: 29876
:vnc_proxy_support_wss: only
:vnc_proxy_cert: /etc/one/ssl/opennebula-certchain.pem
:vnc_proxy_key: /etc/one/ssl/opennebula-key.pem
:vnc_proxy_ipv6: false
```

If using a selfsigned cert, the connection to VNC window in Sunstone will fail, either get a real cert, or manually accept the selfsigned cert in your browser before trying it with Sunstone. Now, VNC sessions should show “encrypted” in the title. You will need to have your browser trust that certificate, in both 443 and 29876 ports in the OpenNebula IP or FQDN.

Running Sunstone with Passenger using FreeIPA/Kerberos auth in Apache

It is also possible to use Sunstone remote authentication with Apache and Passenger. The configuration in this case is quite similar to Passenger configuration but we must include the Apache auth module line. How to configure freeIPA server and Kerberos is outside of the scope of this document, you can get more info in [FreeIPA Apache setup example](#)

As example to include Kerberos authentication we can use two different modules: `mod_auth_gssapi` or `mod_authnz_pam` And generate the keytab for http service, here is an example with Passenger:

```
LoadModule auth_gssapi_module modules/mod_auth_gssapi.so

<VirtualHost *:80>
  ServerName sunstone-server
  PassengerUser oneadmin
  # !!! Be sure to point DocumentRoot to 'public'!
  DocumentRoot /usr/lib/one/sunstone/public
  <Directory /usr/lib/one/sunstone/public>
    # Only is possible to access to this dir using a valid ticket
    AuthType GSSAPI
    AuthName "EXAMPLE.COM login"
    GssapiCredStore keytab:/etc/http.keytab
    Require valid-user
    ErrorDocument 401 '<html><meta http-equiv="refresh" content="0; URL=https://
→yourdomain"><body>Kerberos authentication did not pass.</body></html>'
    AllowOverride all
    # MultiViews must be turned off.
    Options -MultiViews
  </Directory>
</VirtualHost>
```

Note: User must generate a valid ticket running `kinit` to get acces to Sunstone service. You can also set a custom 401 document to warn users about any authentication failure.

Now our configuration is ready to use Passenger and Kerberos, restart -or reload apache configuration- and point to the virtual host using a valid ticket to check if everything is running.

Running Sunstone in Multiple Servers

You can run Sunstone in several servers and use a load balancer that connects to them. Make sure you are using memcache for sessions and both Sunstone servers connect to the same memcached server. To do this change the

parameter `:memcache_host` in the configuration file. Also make sure that both Sunstone instances connect to the same OpenNebula server.

MarketPlace

If you plan on using the `MarketPlaceApp` download functionality the Sunstone server(s) will need access to the `MarketPlace` backends.

If you are using `Phusion Passenger`, take the following recommendations into account:

- Set `PassengerResponseBufferHighWatermark` to `0`.
- Increase `PassengerMaxPoolSize`. Each `MarketPlaceApp` download will take one of this application processes.
- If `Passenger Enterprise` is available, set `PassengerConcurrencyModel` to `thread`.

If you are using another backend than `Passenger`, please port these recommendations to your backend.

VMWARE INFRASTRUCTURE SETUP

6.1 Overview

After configuring the OpenNebula front-end and the vCenter nodes, the next step is to learn what capabilities can be leveraged from the vCenter infrastructure and fine tune the OpenNebula cloud to make use of them.

The Virtualization Subsystem is the component in charge of talking with the hypervisor and taking the actions needed for each step in the VM life-cycle. This Chapter gives a detailed view of the vCenter drivers, the resources it manages and how to setup OpenNebula to leverage different vCenter features.

6.1.1 How Should I Read This Chapter

You should be reading this chapter after performing the *vCenter node install*.

This Chapter is organized in the *vCenter Driver Section*, which introduces the vCenter integration approach under the point of view of OpenNebula, with description of how to import, create and use VM Templates, resource pools, limitations and so on; the *Networking Setup Section* section that glosses over how OpenNebula can consume or create networks and how those networks can be used and then the *Datastore Setup Section* which introduces the concepts of OpenNebula datastores as related to vCenter datastores, and the VMDK image management made by OpenNebula.

After reading this Chapter, you can delve on advanced topics like OpenNebula upgrade, logging, scalability in the *Reference Chapter*. The next step should be proceeding to the Operations guide to learn how the Cloud users can consume the cloud resources that have been set up.

6.1.2 Hypervisor Compatibility

All this Chapter applies exclusively to vCenter hypervisor.

6.2 vCenter Driver

The vCenter driver for OpenNebula enables the interaction with vCenter to control the life-cycle of vCenter resources such as Virtual Machines, Templates, Networks and VMDKs.

6.2.1 OpenNebula approach to vCenter interaction

OpenNebula consumes resources from vCenter using import tools, although OpenNebula can create on its own switches, port groups and VMDK files. OpenNebula uses vCenter object references in order to control resources.

Managed Object Reference

vCenter resources like VMs, Templates, Datastores, Networks, Hosts and many more have an object identifier called Managed Object Reference, or moref, which is used by vCenter and OpenNebula to locate and manage these resources. Morefs have the following pattern:

- vm-XXXXX for Virtual Machines and Templates e.g vm-2543
- datastore-XXXXX for Datastores e.g datastore-411
- network-XXXXX for vCenter port groups e.g network-17
- domain-XXXXX for vCenter clusters e.g domain-c7
- group-pXXXXX for Storage DRS Clusters e.g group-p1149

OpenNebula stores the moref in attributes inside templates definitions. These are the attributes used by OpenNebula:

- VCENTER_CCR_REF. Contains a cluster moref.
- VCENTER_NET_REF. Contains a port group moref.
- VCENTER_DS_REF. Contains a datastore moref.
- VCENTER_DC_REF. Contains a datacenter moref.
- VCENTER_TEMPLATE_REF. Contains a VM template moref.
- DEPLOY_ID. When a VM is instantiated or imported, it will contain the VM's moref.

The Managed Object Reference is a unique identifier in a specific vCenter instance, so we could find two resources with the same moref in two different vCenter servers. That's why a vCenter Instance UUID is used together with the moref to uniquely identify a resource. An instance uuid has a pattern like this 805af9ee-2267-4f8a-91f5-67a98051eebc.

OpenNebula stores the instance uuid inside a template definition in the following attribute:

- VCENTER_INSTANCE_ID

OpenNebula's import tools, which are explained later, will get the morefs and vcenter's instance uuid for you when a resource is imported or created, but if you want to know the managed object reference of a resource we offer you the following information.

Getting a Managed Object Reference

In vSphere's web client, when we click on a resource in the Inventory like a Virtual Machine, the URL in your browser's changes. If you examine the URL at the end, you'll find a parameter ServerObjectRef which is followed by the instance uuid and you'll also find the resource type (VirtualMachine, Datastore...) followed by the moref.

Here you have two examples where you can find the instance uuid and the moref:

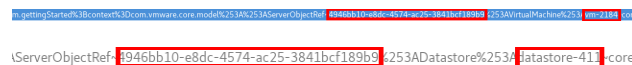

The screenshot shows a URL fragment: `ServerObjectRef=946bb10-e8dc-4574-ac25-3841bcf189b8%253ADatastore%253Adatastore-411%2Ecore`. The instance UUID `946bb10-e8dc-4574-ac25-3841bcf189b8` and the moref `datastore-411` are highlighted with red boxes.

If you want to get information about a resource, you can use the Managed Object Browser provided by VMWare, which listens on <https://x.x.x.x/mob/> where x.x.x.x is the FQDN/IP of your vCenter instance. Use your vSphere credentials and you can browse a resource using a URL like this <https://x.x.x.x/mob/?moid=yyyyy> where yyyyy is the moref of the resource you want to browse.

This is a screenshot of a virtual machine browsed by the Managed Object Browser:

The screenshot shows a browser window displaying the OpenNebula management interface. The title bar indicates the browser is 'No es seguro' and the URL is 'http://ocenter3.noblechassis.com:2184'. The page content shows 'Managed Object Type: ManagedObjectReference:VirtualMachine' and 'Managed Object ID: vm-2184'. Below this is a 'Properties' section with a table listing various attributes and their values:

Name	Type	Value
alarmCheckEnabled	Boolean	true
alarmPeriod	CustomField[]	
capacity	VirtualMachineCapacity	capacity
config	VirtualMachineConfigInfo	config
configBase	Event[]	
configBase	ManagedObjectReference	"vm"
customValue	CustomField[]	
datastore	ManagedObjectReference:Datastore	datastore-812 (79)
desiredStartDate	Alarm[]	<ul style="list-style-type: none"> desiredStartDate_alarm_10.10.21.81 Alarm[] desiredStartDate_alarm_10.10.21.81 Alarm[] desiredStartDate_alarm_10.10.21.81 Alarm[] desiredStartDate_alarm_10.10.21.81 Alarm[]

VMware VM Templates and OpenNebula

In OpenNebula, Virtual Machines are deployed from VMware VM Templates that **must exist previously in vCenter and must be imported into OpenNebula**. There is a one-to-one relationship between each VMware VM Template and the equivalent OpenNebula VM Template. Users will then instantiate the OpenNebula VM Template and OpenNebula will create a Virtual Machine clone from the vCenter template.

Note: After a VM Template is cloned and booted into a vCenter Cluster it can access VMware advanced features and it can be managed through the OpenNebula provisioning portal -to control the life-cycle, add/remove NICs, make snapshots- or through vCenter (e.g. to move the VM to another datastore or migrate it to another ESX). OpenNebula will poll vCenter to detect these changes and update its internal representation accordingly.

There is no need to convert your current Virtual Machines or Templates, or import/export them through any process; once ready just save them as VM Templates in vCenter, following [this procedure](#) and import it into OpenNebula as explained later in this chapter.

When a VMware VM Template is imported, OpenNebula will detect any virtual disk and network interface within the template. For each virtual disk, OpenNebula will create an OpenNebula image representing each disk discovered in the template. In the same way, OpenNebula will create a network representation for each standard or distributed port group associated to virtual network interfaces found in the template.

Warning: The process that discovers virtual disks and networks and then creates OpenNebula representations take some time depending on the number of discovered resources and the operations that must be performed so be patient.

The following sections explain some features that are related with vCenter templates and virtual machines deployed by OpenNebula.

Linked Clones

In OpenNebula, a new VM is deployed when a clone of an existing vCenter template is created, that's why OpenNebula requires that templates are first created in vCenter and then imported into OpenNebula.

In VMWare there are two types of cloning operations:

- The Full Clone. A full clone is an independent copy of a template that shares nothing with the parent template after the cloning operation. Ongoing operation of a full clone is entirely separate from the parent template. This is the default clone action in OpenNebula.
- The Linked Clone. A linked clone is a copy of a template that shares virtual disks with the parent template in an ongoing manner. This conserves disk space, and allows multiple virtual machines to use the same software installation.

When the **onevcenter** tool is used to import a vCenter template, as explained later, you'll be able to specify if you want to use linked clones when the template is imported. Note that if you want to use linked clones, OpenNebula has to create delta disks on top of the virtual disks that are attached to the template. This operation will modify the template so you may prefer that OpenNebula creates a copy of the template and modify that template instead, the **onevcenter** tool will allow you to choose what you prefer to do.

Important: Linked clone disks cannot be resized.

Note: Sunstone does not allow you to specify if you want to use Linked Clones as the operations involved are heavy enough to keep them out of the GUI.

VM Placement

In OpenNebula, by default, a new virtual machine cloned from a vCenter template will be displayed in the same folder where the template lives in vSphere's VM and Templates inventory. However you have the chance to select in which folder you want to see the VM's based on that template.

For example, if you have the following directory tree and you want VMs to be placed in the VMs folder under Management, the path to that folder from the datacenter root would be `/Management/VMs`. You can use that path in different OpenNebula actions e.g when a template is imported.

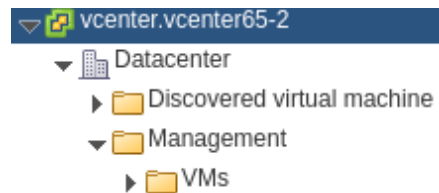

Resource Pools in OpenNebula

OpenNebula can place VMs in different Resource Pools. There are two approaches to achieve this:

- fixed per Cluster basis
- flexible per VM Template basis.

Fixed per Cluster basis

In the fixed per Cluster basis approach, the vCenter connection that OpenNebula use can be confined into a Resource Pool, to allow only a fraction of the vCenter infrastructure to be used by OpenNebula users. The steps to confine OpenNebula users into a Resource Pool are:

- Create a new vCenter user.
- Create a Resource Pool in vCenter and assign the subset of Datacenter hardware resources wanted to be exposed through OpenNebula.
- Give vCenter user Resource Pool Administration rights over the Resource Pool.
- Give vCenter user Resource Pool Administration (or equivalent) over the Datastores the VMs are going to be running on.

- Import the vCenter cluster into OpenNebula as explained later. The import action will create an OpenNebula host.
- Add a new attribute called `VCENTER_RESOURCE_POOL` to OpenNebula's host template representing the vCenter cluster (for instance, in the info tab of the host, or in the CLI), with the reference to a Resource Pool.

Attributes		
AVAILHOST	2	✎ 🗑
CPU SPEED	2195.0	✎ 🗑
HYPERVISOR	vcenter	✎ 🗑
IM_MAD	vcenter	✎ 🗑
TOTALHOST	2	✎ 🗑
TOTAL_WILDS	1	✎ 🗑
VM_MAD	vcenter	✎ 🗑
VCENTER_RESOURCE_POOL	<input type="text" value="TestResourcePool"/>	🗑

Flexible per VM Template

The second approach is more flexible in the sense that all Resource Pools defined in vCenter can be used, and the mechanism to select which one the VM is going to reside into can be defined using the attribute `VCENTER_RESOURCE_POOL` in the OpenNebula VM Template.

Once we have in OpenNebula an imported template, we can **update it** from the CLI or the Sunstone interface and we will have two choices:

- Specify a fixed Resource Pool that will be used by any VM based on the template.
- Offer a list of Resource Pools so the user can select one of them when a VM is instantiated.

Using the CLI we would use the `onetemplate update` command and we would add or edit the `VCENTER_RESOURCE_POOL` attribute.

If we want to specify a Resource Pool, that attribute would be placed inside the template and would contain a reference to the resource pool.

```
VCENTER_RESOURCE_POOL="TestResourcePool/NestedResourcePool"
```

If we wanted to offer a list to the user, we would place the `VCENTER_RESOURCE_POOL` attribute inside a `USER_INPUT` element, and it would contain a string that represents a list. Let's see an example:

```
USER_INPUTS=[
  VCENTER_RESOURCE_POOL="O|list|Which resource pool you want this VM to run in?_
  ↪|TestResourcePool/NestedResourcePool,TestResourcePool|TestResourcePool/
  ↪NestedResourcePool" ]
```

The `VCENTER_RESOURCE_POOL` has the following elements:

- `O`: it means that it is optional to select a Resource Pool.
- `list`: this will be a list shown to users.
- `Which resource pool you want this VM to run in?:` that's the question that will be shown to users.
- `TestResourcePool/NestedResourcePool,TestResourcePool`: that's the list of Resource Pool references separated with commas that are available to the user.
- `TestResourcePool/NestedResourcePool`: is the default Resource Pool that will be selected on the list.

Note: As we'll see later, the import tools provided by OpenNebula will create the `VCENTER_RESOURCE_POOL` attribute easily.

Using Sunstone we have the same actions described for the `onevcenter` tool.

If we want to specify a Resource Pool we should select Fixed from the Type drop-down menu and introduce the reference under Default Resource Pool:

If we wanted to offer a list to the user:

- We would select Provide on Instantiation from the Type drop-down menu.
- We would specify the default value that we want to be selected in the list.
- We would introduce the references of the Resource Pools that we want to include in the list, using a comma to separate values.

Referencing a Resource Pool

The `VCENTER_RESOURCE_POOL` attribute expects a string containing the name of the Resource Pool. If the Resource Pool is nested, the name of the Resource Pool should be preceded by slashes and the names of the parent Resource Pools.

For instance, a Resource Pool “NestedResourcePool” nested under “TestResourcePool”

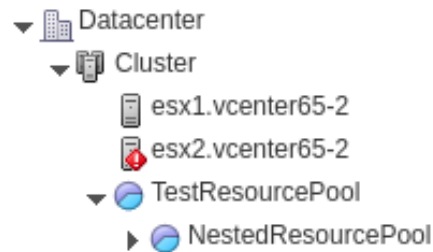

would be represented as “TestResourcePool/NestedResourcePool”:

```
VCENTER_RESOURCE_POOL="TestResourcePool/NestedResourcePool"
```

Resource deletion in OpenNebula

There are different behavior of the vCenter resources when deleted in OpenNebula.

The following resources are NOT deleted in vCenter when deleted in OpenNebula:

- VM Templates.
- Networks. Unless OpenNebula has created the port groups and/or switches instead of just consume them.
- Datastores.

The following resource are deleted in vCenter when deleted in OpenNebula:

- Virtual Machines.
- Images. A VMDK or ISO file will be deleted in vCenter unless the VCENTER_IMPORTED attribute is set to YES.

6.2.2 Considerations & Limitations

- **Unsupported Operations:** The following operations are **NOT** supported on vCenter VMs managed by OpenNebula, although they can be performed through vCenter:

Operation	Note
disk snapshots	Only system snapshots are available for vCenter VMs

- **No Security Groups:** Firewall rules as defined in Security Groups cannot be enforced in vCenter VMs.
- **No files in context:** Passing entire files to VMs is not supported, but all the other CONTEXT sections will be honored.
- Image names cannot contain spaces.
- vCenter credential password cannot have more than 22 characters.
- If you are running Sunstone using nginx/apache you will have to forward the following headers to be able to interact with vCenter, HTTP_X_VCENTER_USER, HTTP_X_VCENTER_PASSWORD and HTTP_X_VCENTER_HOST (or, alternatively, X_VCENTER_USER, X_VCENTER_PASSWORD and X_VCENTER_HOST). For example in nginx you have to add the following attrs to the server section of your nginx file: (underscores_in_headers on; proxy_pass_request_headers on;).

Snapshot limitations

OpenNebula treats **snapshots** a tad different than VMware. OpenNebula assumes that they are independent, whereas VMware builds them incrementally. This means that OpenNebula will still present snapshots that are no longer valid if one of their parent snapshots are deleted, and thus revert operations applied upon them will fail. The snapshot preserves the state and data of a virtual machine at a specific point in time including disks, memory, and other devices, such as virtual network interface cards so this operation may take some time to finish.

vCenter impose some limitations and its behavior may differ from vCenter 5.5 to 6.5. If you create a snapshot in OpenNebula note the following limitations:

- **It's not a good idea to add or detach disks or nics if you have created a snapshot.** DISKs and NICs elements will be removed from your OpenNebula VM and if you revert to your snapshot, those elements that were added or removed won't be added again to OpenNebula VM and vCenter configuration may not be in sync with OpenNebula's representation of the VM. It would be best to remove any snapshot, perform the detach actions and then create a snapshot again affecting operations.
- If despite the previous point you try to detach a disk while the VM is powered on, OpenNebula will not allow this action. If you detach the disk while the VM is in POWEROFF OpenNebula will remove the DISK element but the disk won't be removed from vCenter.
- You cannot perform the disk save as operation unless the VM is powered off.
- You cannot resize disks.

6.2.3 Configuring

The vCenter virtualization driver configuration file is located in `/etc/one/vcenter_driver.default`. This XML file is home for default values for OpenNebula VM templates and images.

Default values for Virtual Machine attributes will be located inside a TEMPLATE element under a VM element while default values for Images (e.g a representation of a VMDK file) will be located inside a TEMPLATE element under an IMAGE element.

So far the following default values for VM NIC can be set:

Attribute	Description	Values
MODEL	It will specify the network interface card model. By default it is set to vmxnet3.	e1000 e1000e pcnet32 sriovethernetcard vmxnetm vmnet2 vmnet3
INBOUND_AVG_BW	Average bitrate for the interface in kilobytes/second for inbound traffic.	
INBOUND_PEAK_BW	Maximum bitrate for the interface in kilobytes/second for inbound traffic.	
OUTBOUND_AVG_BW	Average bitrate for the interface in kilobytes/second for outbound traffic.	
OUTBOUND_PEAK_BW	Maximum bitrate for the interface in kilobytes/second for outbound traffic.	

Note: You can use the template attribute NIC_DEFAULT/MODEL to set a default nic model into your deployed machines. Note that NIC/MODEL have preference and priority. If you don't explicitly set any of these values vCenter driver will: for OpenNebula managed NICs (managed NICs) get the model from vCenter driver defaults file (/etc/one/vcenter_driver.default), and for vCenter managed NICs (unmanaged NICs) delegate the decision to vCenter (ie. will use the vCenter VM Template definition of the NIC).

Default attributes for VM GRAPHICS:

Attribute	Description	Values
KEYMAP	It will specify the keymap for a remote access through VNC	any keymap code

So far the following default values for an IMAGE can be set:

Attribute	Description	Values
VCENTER_ADAPTER_TYPE	Controller that will handle the image in vCenter	lsiLogic ide busLogic
VCENTER_DISK_TYPE	The vCenter Disk Type of the image.	thin thick eagerZeroedThick
DEV_PREFIX	Prefix for the emulated device the image will be mounted at. By default sd is used.	hd sd

It is generally a good idea to place defaults for vCenter-specific attributes. The following is an example:

```
<VCENTER>
  <VM>
    <TEMPLATE>
      <NIC>
        <MODEL>vmxnet3</MODEL>
        <INBOUND_AVG_BW>100</INBOUND_AVG_BW>
      </NIC>
      <GRAPHICS>
        <KEYMAP>US</KEYMAP>
      </GRAPHICS>
    </TEMPLATE>
  </VM>
  <IMAGE>
    <TEMPLATE>
      <DEV_PREFIX>sd</DEV_PREFIX>
      <VCENTER_DISK_TYPE>thin</DISK_TYPE>
      <VCENTER_ADAPTER_TYPE>lsiLogic</ADAPTER_TYPE>
    </TEMPLATE>
  </IMAGE>
</VCENTER>
```

Also you have `/etc/one/vcenter_driver.conf` where you can define the following attributes:

Attribute	Description	Value
vm_poweron_wait_default	Timeout to deploy VMs in vCenter	Integer
debug_information	If you want more error information in vCenter driver	true or false

6.2.4 vCenter Import Tool

vCenter clusters, VM templates, networks, datastores and VMDK files located in vCenter datastores can be easily imported into OpenNebula:

- Using the **onevcenter** tool from the command-line interface

```
$ onevcenter <command> -o <object type> -h <opennebula host_id> [<options>] [<args>]
```

- Using the Import button in Sunstone.

The Import button will be available once the `admin_vcenter` view is enabled in Sunstone. To do so, click on your user's name (Sunstone's top-right). A drop-down menu will be shown, click on Views and finally click on `admin_vcenter`.

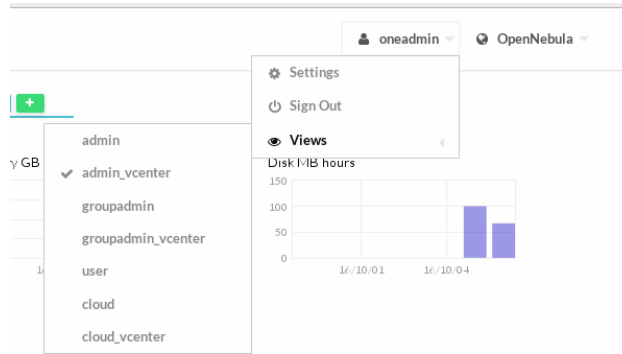

Warning: The image import operation may take a long time. If you use the Sunstone client and receive a “Cannot contact server: is it running and reachable?” the 30 seconds Sunstone timeout may have been reached. In this case either configure Sunstone to live behind Apache/NGINX or use the CLI tool instead.

vCenter resources can be easily imported into OpenNebula, these can be classified:

- Hosts
- Datastores
- Networks
- Templates
- Wilds
- Images

Importing vCenter Clusters

vCenter cluster is the first thing that you will want to add into your vcenter installation because all other vcenter resources depend on it. OpenNebula will import these clusters as opennebula hosts so you can monitor them easily using Sunstone (Infrastructure/Hosts) or through CLI (`onehost`). Also this is the only step where the authentication is to be required so it's important to assure that the process finishes successfully.

Import a cluster with `onevcenter`

When you select a vCenter Cluster to be imported, OpenNebula will create an OpenNebula Host that will represent the vCenter Cluster. Also, you'll have to tell OpenNebula in what OpenNebula Cluster you want to group the OpenNebula Host, if you don't select a previously existing cluster, the default action is that OpenNebula will create an OpenNebula cluster for you. A vCenter Cluster may have the same name in different folders and subfolders of a datacenter, OpenNebula will inform you about the location of the vCenter Cluster so you can identify it.

A sample section follows:

```

$ onevcenter hosts --vcenter <vcenter-host> --vuser <vcenter-username> --vpass
↪<vcenter-password>

Connecting to vCenter: vcenter.host...done!

Exploring vCenter resources...done!

Do you want to process datacenter Datacenter (y/[n])? y

* vCenter cluster found:
  - Name      : Cluster2
  - Location  : /
  Import cluster (y/[n])? y

  In which OpenNebula cluster do you want the vCenter cluster to be included?

  - ID: 100 - NAME: Cluster
  - ID: 101 - NAME: Cluster3

  Specify the ID of the cluster or press Enter if you want OpenNebula to create,
  ↪a new cluster for you:

  OpenNebula host Cluster2 with ID 2 successfully created.

```

Import a cluster with Sunstone

You can also import a cluster from Sunstone. Click on Hosts under the Infrastructure menu entry and then click on the Plus sign, a new window will be opened.

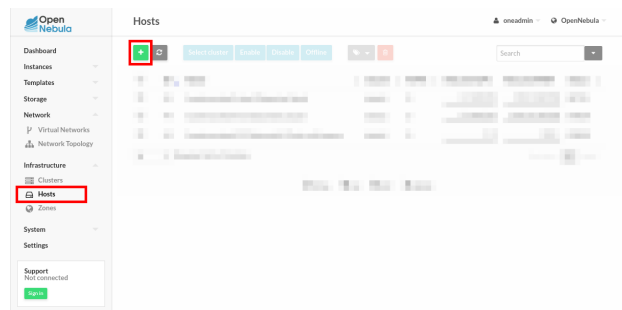

In the new window, select VMWare vCenter from the Type drop-down menu.

Introduce the vCenter hostname or IP address and the credentials used to manage the vCenter instance and click on **Get Clusters**

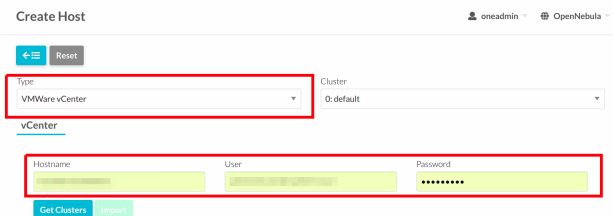

Once you enter the vCenter credentials you'll get a list of the vCenter clusters that haven't been imported yet. You'll

have the name of the vCenter cluster and the location of that cluster inside the Hosts and Clusters view in vSphere.

Note: A vCenter cluster is considered that it hasn't been imported if the cluster's moref and vCenter instance uuid is not found in OpenNebula's image pool.

If OpenNebula finds new clusters they will be grouped by the datacenter they belong.

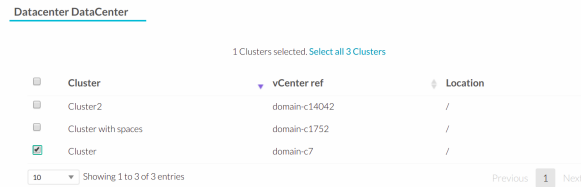

Before you check one or more vCenter clusters to be imported, you can select an OpenNebula cluster from the drop-down Cluster menu, if you select the default datastore (ID:0), OpenNebula will create a new OpenNebula cluster for you.



Select the vCenter clusters you want to import and finally click on the Import button. Once the import tool finishes you'll get the ID of the OpenNebula hosts created as representations of the vCenter clusters.

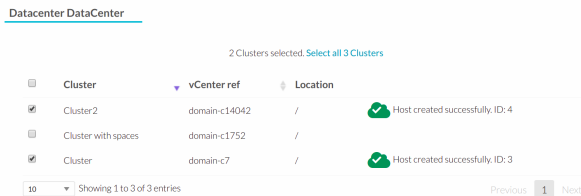

You can check that the hosts representing the vCenter clusters have a name containing the cluster name, and if there is name collision with a previously imported vCenter cluster, a string is added to avoid the collision. Also you can see that if you select the default datastore, OpenNebula will assign a new OpenNebula cluster with the same name of the imported vCenter cluster.

ID	Name	Cluster	RVMS	Allocated CPU	Allocated MEM	Status
4	Cluster2	100	0	0 / 1000 (0%)	0KB / 21.9GB (0%)	ON
3	Cluster	102	0	0 / 1000 (0%)	0KB / 21.9GB (0%)	ON

Note that if you delete an OpenNebula host representing a vCenter cluster and if you try to import it again you may have an error like the following.

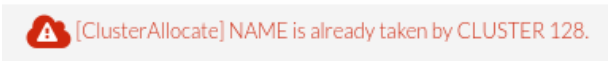

In that case should specify the right cluster from the Cluster drop-down menu or remove the OpenNebula Cluster so OpenNebula can create the cluster again automatically when the vCenter Cluster is imported.

Note: It's important to understand that OpenNebula will see vCenter Clusters as OpenNebula hosts, and an OpenNebula Cluster is created too when a new vCenter Cluster is imported as an OpenNebula host. All resources from that vCenter cluster (networks and storage) will be automatically imported to that same OpenNebula Cluster.

Note: You can define `VM_PREFIX` attribute within host template. This attribute means that when you instantiate a VM in this host, all vm will be named begin with `VM_PREFIX`.

Importing vCenter resources

Once you have imported your vCenter cluster you can import the rest of the vCenter resources delegating the authentication to the imported OpenNebula host. It's important then to check that the imported host is working otherwise you won't be able to import any resource with the host's credentials.

Importation tool operates with similar way in both Sunstone and Command Line Interface it's completely mandatory to have at least one vCenter cluster already working in order to import the rest of the resources, also in some case like images you need to have imported the proper datastore. Resources like Networks or Datastores could belong to more than one cluster so the tool will warn you about that situation.

We could differentiate the creation of vCenter resources with OpenNebula in two steps:

- Get concrete information about the vCenter server and the desired kind of resource, **list**:
 - [CLI] Using `onevcenter list -o <resource type> -h <host_id> [additional_info]`.
 - [Sunstone] Navigate to the proper section on sunstone and click on import button and select the proper host.

This will show you the list of objects that you can import giving you some information.

- **Import** selecteds resources based on the previous information collected by the first step:
 - [CLI] Using `onevcenter import <desired objects> -o <resource type> -h <host_id> [additional_info]`.

There are several ways to perform this operation, in this list an ID column arranging the unimported resources will appear in addition to the REF column, you can use both columns to select certain resoures:

Command (Example)	Note
<code>onevcenter import ref</code>	This will import the resource with ref
<code>onevcenter import 0</code>	This will import the first resource showed on the list, the resource with IM_ID 0
<code>onevcenter import "ref0, ref1"</code>	This will import both items with refs ref0 and ref1
<code>onevcenter import 0..5</code>	This will import items with IM_ID 0, 1, 2, 3, 4, 5

- [Sunstone] Simply select the desired resources (checking any option) from the previous list

Importing all resources with default configuration

In some scenarios you will want to import every resource of any vCenter server, the importation of some resources like could be the networks have an 'interactive' interface due to they require some options. This makes the automated importation a hard way for the administrator. Despite all of this in both Sunstone and `onevcenter` you can import all the resources from a vCenter host with the default configuration, this makes the labour of importing all resources an easy task.

- [CLI] using `onevcenter import_defaults` command:

```
onevcenter import_defaults -o datastores -h 0
```

This will import all datastores related to the imported OpenNebula host with ID: 0.

- [Sunstone] Click on the first checkbox at the corner of the table.

Importing vCenter Datastores





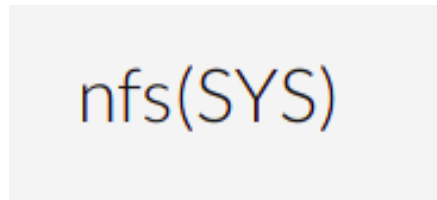

Virtual hard disks, which are attached to vCenter virtual machines and templates, have to be represented in OpenNebula as images. Images must be placed in OpenNebula's image datastores which can be easily created thanks to the import tools. vCenter datastores can be imported using the **onevcenter** tool or the Sunstone user interface.

Once you run the import tool, OpenNebula gives you information about the datastores it finds on each datacenter: the name of the datastore, the capacity of the datastores, and the IDs of OpenNebula Clusters which the vCenter datastores can be assigned to. If there are no OpenNebula Cluster's IDs it means that you haven't imported any vCenter cluster that uses this datastore. Although it's not mandatory that you import vCenter clusters before importing a vCenter datastore you may have later to assign a datastore to an OpenNebula cluster so OpenNebula VMs and Templates can use that datastore.

A vCenter datastore is unique inside a datacenter, so it is possible that two datastores can be found with the same name in different datacenters and/or vCenter instances. When you import a datastore, OpenNebula generates a name that avoids collisions, that name contains the datastore name, the datastore type between parentheses and, if there was another datastore with that name, a suffix. That name can be changed once the datastore has been imported to a more human-friendly name. This is sample name:



There's an important thing to know related to imported datastores. When you import a vCenter datastore, OpenNebula will store the vCenter hostname or IP address, the vCenter user and vCenter password (encrypted) inside the datastore template definition, as OpenNebula needs that credentials to perform API actions on vCenter. So if you ever change the user or password for the vCenter connections from OpenNebula you should edit the datastore template and change that user and/or password (password can be typed on clear and OpenNebula will stored it encrypted).

VCENTER_HOST	vcenter.vcenter3	 
VCENTER_PASSWORD	5TRPipwZQA==	 
VCENTER_USER	administrator@vsphere.local	 

Warning: You need to have already imported the vCenter cluster in order to import the datastore. Otherwise OpenNebula will complain that you need to import the associated vcenter cluster (see the previous point).

Import a datastore with onevcenter

Here's an example showing how a datastore is imported using the command-line interface:

First of all we already have one vCenter cluster imported with ID 0.

```
onevcenter list -o datastores -h 0

# vCenter: vCenter.server
```

(continues on next page)

(continued from previous page)

IMID	REF	NAME	CLUSTERS
0	datastore-15	datastore2	[102]
1	datastore-11	datastore1	[]
2	datastore-15341	datastore1 (1)	[100]
3	datastore-16	nfs	[102, 100]

The import tool (list) will discover datastores in each datacenter and will show the name of the datastore, the capacity and OpenNebula cluster IDs which this datastore will be added to.

Once you know what datastore you want to import:

```
onevcenter import datastore-16 -o datastores -h 0
ID: 100
ID: 101
```

When you select a datastore, two representations of the same datastore are created in OpenNebula: an IMAGE datastore and a SYSTEM datastore that's why you can see that two datastores have been created (unless the datastore is a StorageDRS, in that case only a SYSTEM datastore is created).

Import a datastore with Sunstone

In Sunstone, click on Datastores under the Storage menu entry and then click on the Import button, a new window will be opened.

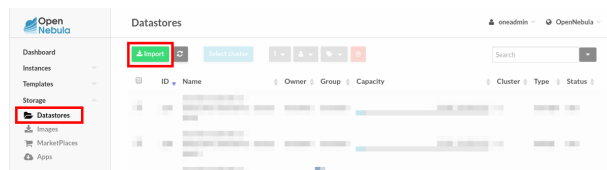

In the new window, choose a cluster to authenticate you into this vCenter instance and click on **Get Datastores**.

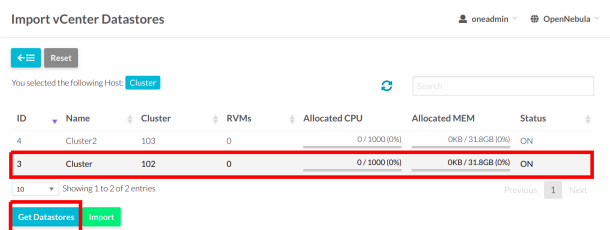

When you click on the Get Datastores button you'll get a list of datastores. You'll get the name of the datastores, its capacity and the IDs of existing OpenNebula clusters where a datastore will be assigned to. Remember, if OpenNebula Clusters IDs column is empty that means that the import tool could not find an OpenNebula cluster where the datastore can be grouped and you may have to assign it by hand later or you may cancel the datastore import tool action and try to import the vCenter clusters before.

OpenNebula will search for datastores that haven't been imported yet.

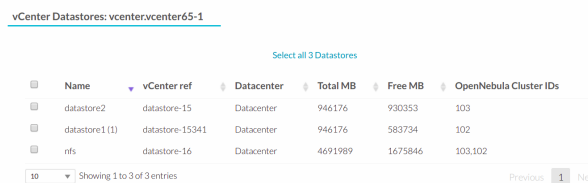

From the list, select the datastore you want to import and finally click on the Import button. Once you select a datastore and click on the Import button, the IDs of the datastores that have been created will be displayed:

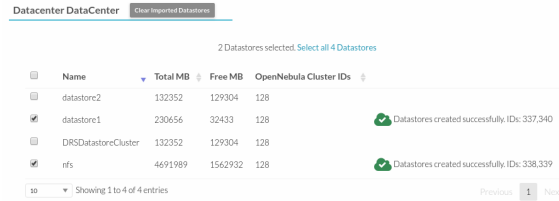

In the datastore list you can check the datastore name. Also between parentheses you can find SYS for a SYSTEM datastore, IMG for an IMAGE datastore or StorDRS for a StorageDRS cluster representation. Remember that datastore name can be changed once the datastore has been imported. Finally the datastores have been added to an OpenNebula cluster too if IDs were listed in the OpenNebula Cluster IDs column.

<input type="checkbox"/>	107	nfs(SYS)	oneadmin	oneadmin	-/-	102.103	SYSTEM	ON
<input type="checkbox"/>	106	nfs(IMG)	oneadmin	oneadmin	0KB/-	102.103	IMAGE	ON
<input type="checkbox"/>	105	datastore1 (1)(SYS)	oneadmin	oneadmin	-/-	102	SYSTEM	ON
<input type="checkbox"/>	104	datastore1 (1)(IMG)	oneadmin	oneadmin	0KB/-	102	IMAGE	ON

Importing vCenter VM Templates

The **onevcenter** tool and the Sunstone interface can be used to import existing VM templates from vCenter.

Important: This step should be performed **after** we have imported the datastores where the template’s hard disk files are located as it was explained before.

Important: Before importing a template check that the datastores that hosts the virtual hard disks have been monitored and that they report its size and usage information. You can’t create images in a datastore until it’s monitored.

The import tools (either the **onevcenter** tool or Sunstone) gives you information about the templates, when a template is selected to be imported, you have to note that OpenNebula inspects the template in search for virtual disks and virtual network interface cards.

It’s mandatory that you import vCenter datastores used by your vCenter template before importing it, because OpenNebula requires an IMAGE datastore to put the images that represents detected virtual disks. If OpenNebula doesn’t find the datastore the import action will fail.

ERROR: datastore nfs: has to be imported first as an image datastore!
✕

OpenNebula will create OpenNebula images that represents found disks, and OpenNebula Virtual Networks that represents the port groups used by the virtual NICs. For example, we have a template that has three disks and a nic connected to the VM Network port group.

▶ Hard disk 1	70,00 MB
▶ Hard disk 2	10,00 MB
▶ Hard disk 3	5,00 MB
▶ Network adapter 1	VM Network (disconnected)

Indeed after the import operation finishes there will be three images representing each of the virtual disks found within the template. The name of the images have been generated by OpenNebula and contains the file name, the datastore where it's found and OpenNebula's template ID so it's easier for you to know what image is associated with what template. Note that these images are non-persistent. The name of the images can be changed after the images have been imported.

278	corelinux7_x86_64_5-000001 - nfs [Template 66]	oneadmin	oneadmin	nfs [vcenter/vcenter3-Datacenter] (IMG)	OS	READY	0
277	corelinux7_x86_64_3-000001 - nfs [Template 66]	oneadmin	oneadmin	nfs [vcenter/vcenter3-Datacenter] (IMG)	OS	READY	0
276	corelinux7_x86_64_4-000001 - nfs [Template 66]	oneadmin	oneadmin	nfs [vcenter/vcenter3-Datacenter] (IMG)	OS	READY	0

Also a virtual network will be created. The name will be the same as vCenter . Note that the virtual network is added automatically to an OpenNebula cluster which contains the vCenter cluster. E.g This network belongs to two OpenNebula cluters (100, 101) in the following screenshot.

0	VM Network	oneadmin	oneadmin	No	100,101	0/255
---	------------	----------	----------	----	---------	-------

A vCenter template name is only unique inside a folder, so you may have two templates with the same name in different folders inside a datacenter. If OpenNebula detects a collision it will add a string (based on a SHA1 hash operation on the VM Template characteristics) to the name to prevent name duplication in OpenNebula. The VM Template name in OpenNebula can be changed once it has been imported. The following screenshot shows an example:



Import a VM Template with onevcenter

This would be the process using the **onevcenter** tool.

```
$ onevcenter list -o templates -h 0
# vCenter: vcenter.Server
IMID REF      NAME
  0 vm-8720    corelinux7 x86_64 with spaces
  1 vm-9199    one-corelinux7_x86_64
  2 vm-8663    dist_nic_test
```

In this example our vcenter.server has 3 templates and they are listed from IM_ID = 0 to 2.

Whenever you are ready to import:

```
onevcenter import vm-1754 -o templates -h 0
- Template: corelinux7_x86_64
```

In this section you'll be asked several questions and different actions will be taken depending on your answers.

First you'll be prompted if you want to use linked clones.

```
Would you like to use Linked Clones with VMs based on this template (y/[n])?
```

If you want to use linked clones with the template, as explained before, you can create a copy of the template so the original template remains intact.

```
Do you want OpenNebula to create a copy of the template, so the original template_
↳remains untouched ([y]/n)?
```

If you want to create a copy of the template, you can give it a name or use the same name with the one- prefix.

```
The new template will be named adding a one- prefix to the name of the original_
↳template.
If you prefer a different name please specify or press Enter to use defaults:_
↳corelinux7_linked_x86_64
```

If a copy of the template is used, this action may take some time as a full clone of the template and its disks has to be performed.

```
WARNING!!! The cloning operation can take some time depending on the size of disks._
↳Please wait...
```

If linked clone usage was selected, delta disks will be created and that action will also require some time.

```
Delta disks are being created, please be patient...
```

Now, either you use linked clones or not, you can select the folder where you want VMs based on this template to be shown in vSphere's VMs and Templates inventory.

```
Do you want to specify a folder where the deployed VMs based on this template will_
↳appear in vSphere's VM and Templates section?
If no path is set, VMs will be placed in the same location where the template lives.
Please specify a path using slashes to separate folders e.g /Management/VMs or press_
↳Enter to use defaults:
```

OpenNebula will inspect the vCenter template and will create images and networks for the virtual disks and virtual networks associated to the template. Those actions will require some time to finish.

```
The existing disks and networks in the template are being imported, please be patient.
↳..
```

The template is almost ready but you have the chance to specify a Resource Pool or provide a list to users so they can select which Resource Pool will be used.

By default OpenNebula will use the first Resource Pool that is available in the datacenter unless a specific Resource Pool has been set for the host representing the vCenter cluster. If you haven't already have a look to the "[Resource Pools in OpenNebula](#)" section in this chapter so you can fully understand the following.

```
This template is currently set to launch VMs in the default resource pool.
Press y to keep this behaviour, n to select a new resource pool or d to delegate the_
↳choice to the user ([y]/n/d)?
```

If you want to select a new resource pool, a list of available Resource Pools will display so you can select one of them:

```
The list of available resource pool is:

- TestResourcePool/NestedResourcePool
- TestResourcePool

Please input the new default resource pool name:
```

If you want to create a list of Resource Pools that will allow the user to select one of them, you have the chance of accepting the list generated by the import tool or enter the references of the Resource Pools using a comma to separate the values:

The list of available resource pools to be presented to the user are
 ↪ "TestResourcePool/NestedResourcePool,TestResourcePool"
 Press y to agree, or input a comma separated list of resource pools to edit ([y]/
 ↪comma separated list)

If you selected a list, you will be asked to select the reference of the default Resource Pool in that list:

The default resource pool presented to the end user is set to "TestResourcePool/
 ↪NestedResourcePool".
 Press y to agree, or input a new resource pool ([y]/resource pool name)

Import a VM Template with Sunstone

In Sunstone, click on VMs under the Template menu entry and then click on the Import button, a new window will be opened.

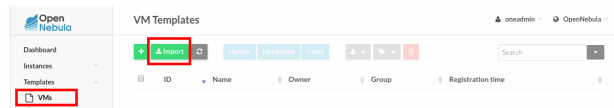

In the new window, choose a cluster to authenticate you into this vCenter instance and click on **Get Templates**.

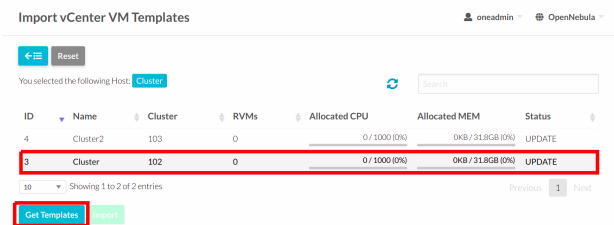

OpenNebula will search for templates that haven't been imported yet.



Before importing a template, you can click on the down arrow next to the template's name and specify the Resource Pools as it was explained in the *Resource Pools in OpenNebula section in this chapter*

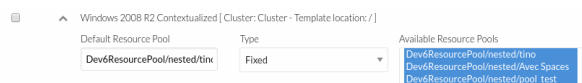

Note: If the vCenter cluster doesn't have DRS enabled you won't be able to use Resource Pools and hence the down arrow won't display any content at all.

Select the template you want to import and finally click on the Import button. **This process may take some time** as OpenNebula will import the disks and network interfaces that exists in the template and will create images and networks to represent them.

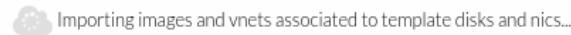

Once the template has been imported you get the template's ID.

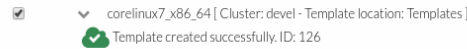

Note: A vCenter template is considered that it hasn't been imported if the template's moref and vCenter instance uuid is not found in OpenNebula's template pool.

Warning: If OpenNebula does not find new templates, check that you have previously imported the vCenter clusters that contain those templates.

Warning: If you want to use linked clones with a template, please import it using the **onevcenter** tool as explained in the previous section.

Note: When an image is created to represent a virtual disk found in the vCenter template, the VCENTER_IMPORTED attribute is set to YES automatically. This attribute prevents OpenNebula to delete the file from the vCenter datastore when the image is deleted from OpenNebula.

After a vCenter VM Template is imported as a OpenNebula VM Template, it can be modified to change the capacity in terms of CPU and MEMORY, the name, permissions, etc. It can also be enriched to add:

- New disks
- New network interfaces
- Context information

Important: If you modify a VM template and you edit a disk or nic that was found by OpenNebula when the template was imported, please read the following notes:

- Disks and nics that were discovered in a vCenter template have a special attribute called OPENNEBULA_MANAGED set to NO.
 - The OPENNEBULA_MANAGED=NO should only be present in DISK and NIC elements that exist in your vCenter template as OpenNebula doesn't apply the same actions that those applied to disks and nics that are not part of your vCenter template.
 - If you edit a DISK or NIC element in your VM template which has OPENNEBULA_MANAGED set to NO and you change the image or virtual network associated to a new resource that is not part of the vCenter template please don't forget to remove the OPENNEBULA_MANAGED attribute in the DISK or NIC section of the VM template either using the Advanced view in Sunstone or from the CLI with the onetemplate update command.
-

Before using your OpenNebula cloud you may want to read about the vCenter specifics.

Importing running Virtual Machines

Once a vCenter cluster is monitored, OpenNebula will display any existing VM as Wild. These VMs can be imported and managed through OpenNebula once the host has been successfully acquired.

In the command line we can list wild VMs with the one host show command:

```
$ onehost show 0
HOST 0 INFORMATION
ID           : 0
NAME        : MyvCenterHost
CLUSTER     : -
[....]

WILD VIRTUAL MACHINES

      NAME                                     IMPORT_ID  CPU
↔  MEMORY test-rp-removeme - Cluster          vm-2184    1
↔      256
[....]
```

In Sunstone we have the Wild tab in the host's information:

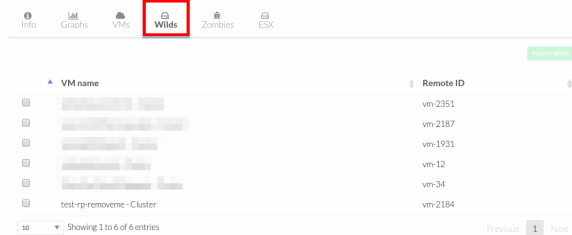

VMs in running state can be imported, and also VMs defined in vCenter that are not in Power On state (this will import the VMs in OpenNebula as in the poweroff state).

Important: Before you import a Wild VM you must have imported the datastores where the VM's hard disk files are located as it was explained before. OpenNebula requires the datastores to exist before the image that represents an existing virtual hard disk is created.

Warning: While the VM is being imported, OpenNebula will inspect the virtual disks and virtual nics and it will create images and virtual networks referencing the disks and port-groups used by the VM so the process may take some time, please be patient.

To import existing VMs you can use the 'onehost importvm' command.

```
$ onehost importvm 0 "test-rp-removeme - Cluster"
$ onevm list
ID USER      GROUP      NAME                STAT UCPU    UMEM HOST          TIME
3  oneadmin  oneadmin  test-rp-removem  runn 0.00    20M [vcenter.v 0d 01h02
```

Also the Sunstone user interface can be used from the host's Wilds tab. Select a VM from the list and click on the Import button.

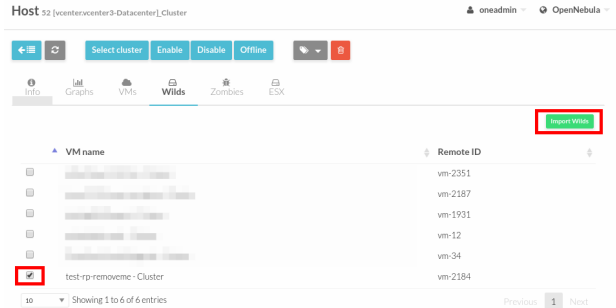

After a Virtual Machine is imported, their life-cycle (including creation of snapshots) can be controlled through OpenNebula. The following operations *cannot* be performed on an imported VM:

- Recover –recreate
- Undeploy (and Undeploy –hard)
- Migrate (and Migrate –live)
- Stop

Once a Wild VM is imported, OpenNebula will reconfigure the vCenter VM so VNC connections can be established once the VM is monitored.

Also, network management operations are present like the ability to attach/detach network interfaces, as well as capacity (CPU and MEMORY) resizing operations and VNC connections if the ports are opened before hand.

Importing vCenter Networks

OpenNebula can create Virtual Network representations of existing vCenter networks (standard port groups and distributed port groups). OpenNebula can handle on top of these representations three types of Address Ranges: Ethernet, IPv4 and IPv6. This networking information can be passed to the VMs through the contextualization process.

When you import a vCenter port group or distributed port group, OpenNebula will create an OpenNebula Virtual Network that represents that vCenter network.

The import tool (either the `onevcenter` tool or Sunstone) gives you information about the found networks on each datacenter:

- The name of the network
- The type of network (Standard Port Group or Distributed Port Group)
- The name of the vCenter cluster where the port group is used and the ID of the OpenNebula host referenced to the proper vCenter cluster.

If there are no OpenNebula Cluster's ID it means that you haven't imported any vCenter cluster that uses this port group so to import properly the network you should have imported the vcenter cluster first.

Note: Multicluster networks are supported by OpenNebula, Port Groups and Distributed Port Groups spanning across than 1 vCenter cluster can be properly imported. OpenNebula will show up the related vCenter clusters and at least 1 should be imported before proceeding with the network import process. Even if it is possible to import a multicluster network having only 1 vCenter cluster imported, it is best to import all vCenter clusters related to the network into OpenNebula first (arranging them into OpenNebula clusters).

A vCenter network name is unique inside a datacenter, so it is possible that two networks can be found with the same name in different datacenters and/or vCenter instances. When a network is imported, OpenNebula checks its existing

network pool and generates a name that avoids collisions if needed. This name can be changed once the virtual network has been imported. The following screenshot shows an example:



Warning: You need to have already imported the vCenter cluster in order to import any vnet. Otherwise OpenNebula will complain that you need to import the associated vcenter cluster (see the previous point).

Import networks with onevcenter

The import tool will discover port groups in each datacenter and will show the name of the port group, the port group type (Port Group or Distributed Port Group), the cluster that uses that port group and the OpenNebula cluster ID which this virtual network will be added to.

You will notice that the cluster name have color, this can mean two things:

In case that the network had more than 1 vCenter cluster associated, the list command will show a list of the OpenNebula clusters.

Here's an example showing how a standard port group or distributed port group is imported using the command-line interface:

Like always we need first to get the list of the importable objects:

```
$ onevcenter list -o networks -h 0

# vCenter: vcenter.Server

  IMID REF          NAME          CLUSTERS
  ---  ---          ---          ---
  0    network-12    VM Network    [100, 102]
  1    network-12245 testing00     [100, 102]
  2    network-12247 testing03     [102]
  3    network-12248 testing02     [102]
  4    network-12246 testing01     [100, 102]
```

Note: It is possible to get networks with CLUSTERS column set to -1, this means that there are vCenter clusters related to the network that you don't have already imported depending on how many -1 you are seeing, look at the previous note above.

With this information, we now want to import 'Testing0*' networks (it's common to import more than one network). Easily with the list command we realize that testing networks are included in IMIDs 1 to 4.

```
$ onevcenter import 1..4 -o networks -h 0
```

or

```
$ onevcenter import "network-12245, network-12247, network-12246, network-12248" -o_
networks -h 0
```

(continues on next page)

(continued from previous page)

Even if the second option (above) is too long it's still very useful when you want to import a couple of not sequential nets. After this you'll be asked several questions and different actions will be taken depending on your answers.

If you want to import the network and the vnet has vlan id it will show to you in first place. Next step is to assign an Address Range. You can know more about address ranges in the Managing Address Ranges section.

First you have to specify the size of the address pool:

```
How many VMs are you planning to fit into this network [255]?
```

Next you have to specify the type of address pool:

```
What type of Virtual Network do you want to create (IPv[4],IPv[6],[E]thernet) ?
```

If you choose an Ethernet pool, you can choose the first mac address in the pool although it's optional:

```
Please input the first MAC in the range [Enter for default]:
```

If you choose an IPv4 address pool, you'll have to specify the initial IP address and the first mac address in the pool (optional):

```
Please input the first IP in the range: 10.0.0.0
Please input the first MAC in the range [Enter for default]:
```

If you choose an IPv6 address pool, you'll have to specify the first mac address in the pool (optional) and if you want to use SLAAC:

```
Please input the first MAC in the range [Enter for default]:
Do you want to use SLAAC Stateless Address Autoconfiguration? ([y]/n)
```

For SLAAC autoconfiguration you'll have to specify the GLOBAL PREFIX and the ULA_PREFIX or use the defaults.

```
Please input the GLOBAL PREFIX [Enter for default]:
Please input the ULA PREFIX [Enter for default]:
```

If you don't want to use SLAAC autoconfiguration you'll have to specify an IPv6 address and the prefix length.

```
Please input the IPv6 address (cannot be empty):
Please input the Prefix length (cannot be empty):
```

Finally if the network was created successfully you'll get a message with the name of the network (generated automatically by OpenNebula as described earlier) and the numeric ID.

```
OpenNebula virtual network TestPG - Cluster [vcenter_vcenter3 - Datacenter] b28ffce07734 with ID 140 created with size 255!
```

Import networks with Sunstone

In Sunstone the process is similar, click on Virtual Networks under the Network menu entry and then click on the Import button, a new window will be opened.

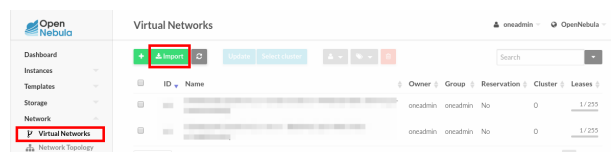

In the new window, choose a cluster to authenticate you into this vCenter instance and click on **Get Networks**.

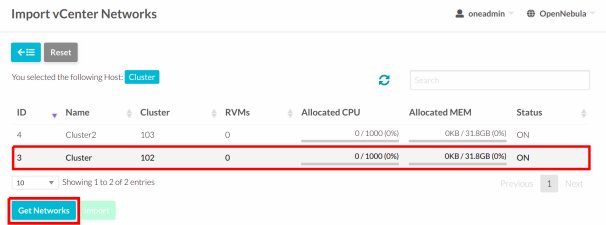

When you click on the Get Networks, you'll get a list of port groups. You'll get the name of the port group, its type, the cluster, the location of the cluster and the IDs of an existing OpenNebula cluster which this virtual network will be assigned to. If OpenNebula Clusters ID is -1 that means that the import tool could not find an OpenNebula cluster where the datastore can be grouped and you may have to assign it by hand later or you may cancel the datastore import tool action and try to import the vCenter clusters before.

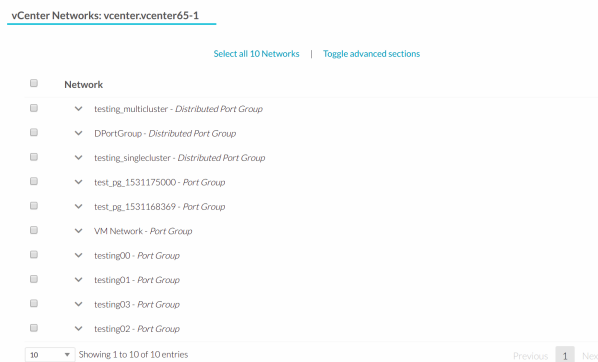

Before importing a network, you can click on the down arrow next to the network's name and specify the type of address pool you want to configure:

- eth for an Ethernet address range pool.
- ipv4 for an IPv4 address range pool.
- ipv6 for an IPv6 address range pool with SLAAC.
- ipv6_static for an IPv6 address range pool without SLAAC (it requires an IPv6 address and a prefix length).

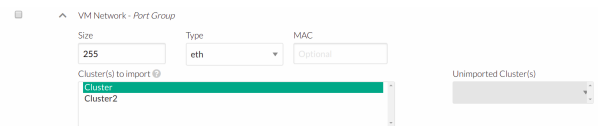

When you import a network, the default address range is a 255 MAC addresses pool.

Finally click on the Import button, the ID of the virtual network that has been created will be displayed:



Warning: If OpenNebula does not find new networks, check that you have previously imported the vCenter clusters that are using those port groups.

Importing vCenter Images

OpenNebula can create Image representations of vCenter VMDK and ISO files that are present in vCenter datastores.

A VMDK or ISO file may have the same name in different locations inside the datastore. The import tools will provide you the following information for each found file:

- The path inside the datastore.
- The size of the VMDK file. This will be the capacity size of the VMDk file as it was seen from a Virtual Machine perspective. For example, a VMDK file may be only a few KBs in size as it may have been thin provisioned, however the size that would report a Virtual Machine, if that file was attached to the VM, would be different and hence the capacity is displayed if it's available otherwise it will display the file's size.
- The type of the file: VmDiskFileInfo or IsoImageFileInfo.

When you import an image, OpenNebula generates a name that avoids collisions, that name contains the image name and, if there was another image with that name, a suffix. That name can be changed once the image has been imported to a more human-friendly name. This is sample name:

```
one-11-corelinux7_x86_64-11_2
```

The import tools will look for files that haven't been previously imported, checking if there's a file with the same PATH and DATASTORE_ID attributes.

Import images with onevcenter

The **onevcenter** tool and the Sunstone interface can be used to import this kind of files.

The onevcenter tool needs that an OpenNebula's IMAGE datastore name is specified as an argument. OpenNebula will browse the datastores and look for VMDK and ISO files. This means that it's mandatory to have the proper vCenter image datastore imported into OpenNebula, we can pass on this information through onevcenter tool with -d option so be sure to check this before the import image operation:

This is an easy way for check available vcenter datastores:

```
onedatastore list | grep -E 'img.*vcenter'
```

100	datastore2 (IM	924G	100%	102	1	img	vcenter	vcenter	on
102	datastore1 (IM	924G	88%	-	0	img	vcenter	vcenter	on
106	nfs (IMG)	4.5T	39%	100,102	24	img	vcenter	vcenter	on

Here's an example showing how a VMDK file can be imported using the command-line interface. In this case we are going to use datastore1 (102) and host 0:

```
onevcenter list -o images -h 0 -d 106
# vCenter: vcenter.vcenter65-1
```

IMID	REF	PATH
0	one-21	one_223304/21/one-21.vmdk
1	Core-current.iso.iso	one_223304/22/Core-current.iso.iso

Once the image has been imported, it will report the OpenNebula image ID.

Import images with Sunstone

Images can also be imported from Sunstone. Click on Images under the Storage menu entry and click on the Import button.

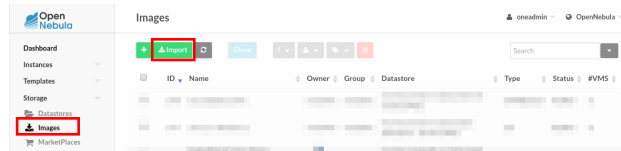

In the new window, choose a cluster to authenticate you into this vCenter instance and click on **Get Images**.

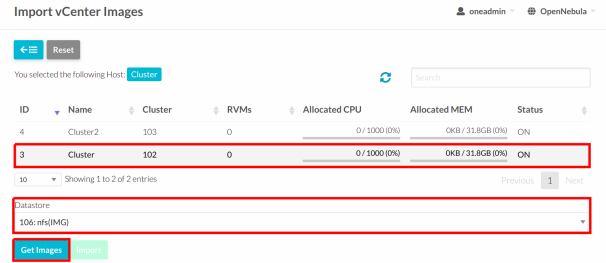

OpenNebula will search for VMDK and ISO files that haven't been imported yet.

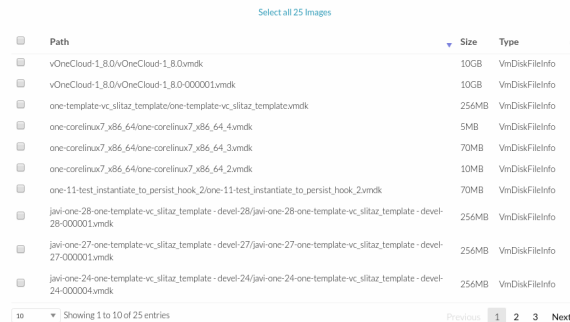

Select the images you want to import and click on the Import button. The ID of the imported images will be reported.

Note: When an image is created using the import tool, the `VCENTER_IMPORTED` attribute is set to `YES` automatically. This attribute prevents OpenNebula to delete the file from the vCenter datastore when the image is deleted from OpenNebula, so it can be used to prevent a virtual hard disk to be removed accidentally from a vCenter template. This default behavior can be changed in `/var/lib/one/etc/remotes/vmm/vcenter/vcenter.rc` by setting `DELETE_IMAGES` to `Yes`.

6.2.5 Migrate vCenter Virtual Machines with OpenNebula

vCenter Driver allows migration of VMs between different vCenter clusters (ie, OpenNebula hosts) and/or. Depending on the type of migration (cold, the VM is powered off, or saved; or live, the VM is migrated while running), or the target (cluster and/or datastore), several requirements needs to be met in order to migrate the machine.

The next table summarize the general limitations, detailed limitation explanation and requirements can be found in sections below.

Migration Type	Hosts	Datstores
COLD	All cases supported	Only VMs with unmanaged disks
LIVE	All cases supported	Only VMs with unmanaged disks

Migrating a VM Between vCenter Clusters (OpenNebula Hosts)

Requirements (both live and cold migrations)

- Every Network attached to the selected VMs need to exists in both vCenter clusters and OpenNebula clusters
- Every Datastore that is used by the VM need to exist in both vCenter clusters and OpenNebula clusters
- **Target OpenNebula host can specify a ESX_MIGRATION_LIST attribute:**
 - If not specified, target ESX host is not explicitly declared and migration may fail
 - If set to an empty string (“”), OpenNebula will randomly chose a target ESX from all the ESXs that belong to the vCenter target cluster
 - If set to a space-separated list of ESX hostnames (that need to belong to the vCenter target cluster), OpenNebula will randomly chose a target ESX from the list

Note: A good place to check if the VM meets the OpenNebula requirements is to peep into the ‘AUTOMATIC_REQUIREMENTS’ attribute of the and check if it includes the target OpenNebula clusters (remember, a cluster in OpenNebula is a collection of hosts, virtual networks and datastores, a cluster in vCenter is represented as a host in OpenNebula).

Requirements (only live migrations)

- vMotion interface enabled in both vCenter clusters (otherwise the driver will warn about compatibility issues)
- OpenNebula live migration only works for running VMs so be sure to check the state before

Usage (CLI)

Cold Migration

```
$ onevm migrate "<VM name>" <destination host id>
```

Live Migration

```
$ onevm migrate --live "<VM name>" <destination host id>
```

Migrating a VM Between Datastores

On a VM migration, target datastore can be changed. Disks belonging to the VM will be migrated to the target datastore. This is useful for rebalancing resources usage among datastores.

Requirements (both cold and live migrations)

- Every Datastore that is used by the VM needs to exist in both vCenter clusters and OpenNebula clusters

Limitations

- **It is not possible to migrate to a different datastore VMs with any managed disk.** Disks added to the VM by OpenNebula (managed disks) are created on a specific folder on the datastore, not on the VM folder. After a migration, vCenter will move that disk from that folder to the VM folder, changing the path, which is not updated by OpenNebula. This means that some operations can fail later on, like disk back-up. For this reason, DS migrations of these VMs are disallowed.

Usage (CLI)

Cold Migration

```
$ onevm migrate "<VM name>" <destination host id> <destination datastore id>
```

Live Migration

```
$ onevm migrate --live "<VM name>" <destination host id> <destination datastore id>
```

6.3 vCenter Datastores

vCenter datastores hosts VMDK files and other file types so VMs and templates can use them, and these datastores can be represented in OpenNebula as both an Images datastore and a System datastore:

- Images Datastore. Stores the images repository. VMDK files are represented as OpenNebula images stored in this datastore.
- System Datastore. Holds disk for running virtual machines, copied or cloned from the Images Datastore.

For example, if we have a vcenter datastore called nfs, when we import the vCenter datastore into OpenNebula, two OpenNebula datastores will be created as an Images datastore and as a System datastore pointing to the same vCenter datastores:

```
* Datastore found:
- Name      : nfs
- Datacenter : Datacenter
- Total MB  : 4691989
- Free MB   : 1564950
- Import name: nfs [vcenter.vcenter5-devel - Datacenter]
Import this datastore [y/n]? y

NOTE: For each vCenter datastore a SYSTEM and IMAGE datastore
will be created in OpenNebula except for a StorageDRS which is
represented as a SYSTEM datastore only.

OpenNebula datastore 315 created!
OpenNebula datastore 316 created!
```

ID	NAME	SIZE	AVAIL	CLUSTERS	IMAGES	TYPE	DS	TM	STAT
313	LocalDatastor	225.3G	17%	0,120	0	img	vcenter	vcenter	on
314	LocalDatastor	225.3G	17%	0,120	0	sys	-	vcenter	on
315	nfs [vcenter.	4.5T	33%	0,120	0	img	vcenter	vcenter	on
316	nfs [vcenter.	4.5T	33%	0,120	0	sys	-	vcenter	on

Important: If the vCenter instance features a read only datastore, please be aware that you should disable the SYSTEM representation of the datastore after importing it to avoid OpenNebula trying to deploy VMs in it.

6.3.1 Images and disks

When the vCenter hypervisor is used we have three OpenNebula image types:

- OS: A bootable disk Image. Every VM template must define one DISK referring to an Image of this type.
- CDROM: These Images are read-only data.
- DATABLOCK: A datablock Image is a storage for data. These Images can be created from previous existing data (e.g uploading a VMDK file), or as an empty drive.

OpenNebula images can be also classified in **persistent** and **non-persistent** images:

- Non-persistent images. These images are used by at least one VM. It can still be used by other VMs. When a new VM using a non-persistent image is deployed a copy of the VMDK file is created.
- Persistent images. A persistent image can be use only by a VM. It cannot be used by new VMs. The original file is used, no copies are created.

Disks attached to a VM will be backed by a non-persistent or persistent image although volatile disks are also supported. Volatile disks are created on-the-fly on the target hosts and they are disposed when the VM is shutdown.

6.3.2 Limitations

- When a vCenter template or wild VM is imported into OpenNebula, the virtual disks are imported, an images are created in OpenNebula representing those virtual disks. Although these images represent files that already exist in the datastores, OpenNebula accounts the size of those imported images as if they were new created files and therefore the datastore capacity is decreased even though no real space in the vCenter datastore is being used by the OpenNebula images. You should understand this limitation if for example an image cannot be imported as OpenNebula reports that no more space is left or if you're using disk quotas.
- No support for disk snapshots in the vCenter datastore.
- Image names and paths cannot contain spaces or non ASCII characters.

6.3.3 The vCenter Transfer Manager

OpenNebula's vCenter Transfer Manager driver deals with disk images in the following way:

- New disk images created by OpenNebula are placed in an Images datastore. They can be created as persistent or non-persistent images.
- Persistent images are used by vCenter VMs from the datastore where the persistent images were created.
- Non-persistent images are copied from the Images datastore where they were created to a System datastore chosen by OpenNebula's scheduler.
- Volatile images are created in a System datastore chosen by the scheduler and deleted from that datastore once it's no longer needed (e.g disk detach or VM's terminate action).
- Creation of empty datablocks and VMDK image cloning are supported, as well as image deletion.

The scheduler chooses the datastore according to the configuration in the `/etc/one/sched.conf` as explained in the Operation's guide:

- By default it tries to optimize storage usage by selecting the datastore with less free space.
- It can optimize I/O by distributing the VMs across available datastores.

The vCenter datastore in OpenNebula is tied to a vCenter instance in the sense that all operations to be performed in the datastore are going to be performed through the vCenter instance and credentials stored in the datastore's template.

vCenter datastores can be represented in OpenNebula to achieve the following VM operations:

- *Upload VMDK files*
- *Upload ISO files*
- *Create empty datablocks*
- Clone VMDKs images
- Delete VMDK images

Important: Note that if you change the vCenter credentials (e.g password change) you will have to update the OpenNebula datastore's template and provide the new credentials so OpenNebula can continue performing vCenter operations.

OpenNebula Clusters

A Cluster is a group of Hosts and clusters can have associated Datastores and Virtual Networks. When a vCenter cluster is imported, the import tool assigns automatically a cluster to the OpenNebula host representing the vCenter cluster.

Important: When a vCenter datastore is imported into OpenNebula, OpenNebula tries to add the datastores to an existing OpenNebula cluster. If you haven't previously imported a vCenter cluster that uses that datastore, the automatic assignment won't have found a suitable OpenNebula cluster and hence the scheduler won't know which are the right datastores that can be used when a VM is deployed. In this case you should add the datastores to the cluster where the OpenNebula host (representing the vCenter Cluster) is found as explained in the Add Resources to Clusters section.

File location used by the Transfer Manager

VMDK files or ISO files are placed and named into a vcenter datastore, according to these rules:

- Persistent images. These images are placed following this pattern: `IMAGE_DIR/IMAGE_ID/one-IMAGE_ID.vmdk`, e.g: `one/258/one-258.vmdk`. `IMAGE_DIR` is by default the directory `one` but a different directory can be used thanks to the `VCENTER_DS_IMAGE_DIR` attribute.
- Non-persistent images. These images are placed following this pattern: `IMAGE_DIR/IMAGE_ID/one-IMAGE_ID.vmdk`, e.g: `one/259/one-259.vmdk`. `IMAGE_DIR` is by default the directory `one` but a different directory can be used thanks to the `VCENTER_DS_IMAGE_DIR` attribute.
- Non-persistent images used by a Virtual Machine. The copy of a non-persistent image follows this pattern: `IMAGE_DIR/IMAGE_ID/one-VMID-IMAGE_ID-DISK_NUMBER.vmdk` where `VMID` is replaced with the VM numeric identifier, `IMAGE_ID` would be the identifier of the original image and `DISK_NUMBER` is replaced with the position of the disk inside the VM.
- Volatile disks attached to a VM. These images are placed following this pattern: `VOLATILE_DIR/one-VMID-DISK_NUMBER.vmdk`, e.g `one-volatile/285/one-285-2.vmdk`. `VOLATILE_DIR` is by default the `one-volatile` directory but a different directory can be used thanks to the `VCENTER_DS_VOLATILE_DIR` attribute.

In the following example we can see that the file associated to the Image with OpenNebula's ID 8 contains the VMDK file using the placement logic explained above.

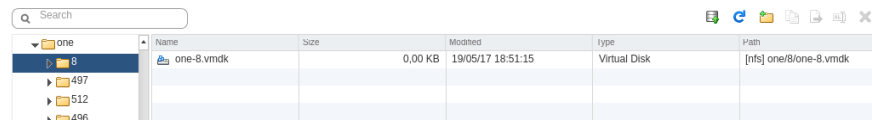

Name	Size	Modified	type	Path
one-8.vmdk	0,00 KB	19/05/17 18:51:15	Virtual Disk	[ntfs] one/8/one-8.vmdk

Important: OpenNebula is committed to not leaving unneeded folders and files on your datastores, however note that in vCenter 6.5 we have detected a bug in its API that currently prevents OpenNebula to delete empty directories created by OpenNebula. Hence you may find empty folders in your datastores inside locations mentioned earlier that you may have to remove by hand if those folders bothers you somehow.

6.3.4 Requirements

In order to use the vCenter datastore, the following requirements need to be met:

- All the ESX servers controlled by vCenter need to mount the same VMFS datastore with the same name.
- The ESX servers need to be part of the Cluster controlled by OpenNebula
- Before you can create images in an IMAGE datastore check that the datastore has been monitored and that it reports its size and usage information. You can't create images in a datastore until it's monitored.

6.3.5 Upload VMDK files

You can upload VMDK files that can be attached to Virtual Machines as Virtual Hard Disks.

The file containing the VMDK can be uploaded in two ways:

- Adding the file from your web browser or
- Specify the path using an URL.

The file to be uploaded can be:

- A standalone VMDK file. This file can also be compressed with gzip or bzip2.
- Flat files and a VMDK descriptor in an archived tar file. Both files must live in the first level of the archived tar file as folders and subfolders are not supported by OpenNebula inside the tar. The tar file can also be compressed with gzip or bzip2.

Using the CLI

You can use the `oneimage` CLI command. Here's an example where we want to upload a standalone vmdk file to the IMAGE datastore with ID 154.

We specify the `vcenter` driver, type, a name and a description. The type parameter can be `OS` (if you want to tell OpenNebula that the image contains an Operating System), `DATABLOCK` and `CDROM`. If you want to specify other options run `oneimage` without parameters and you'll have a list of the parameters and some examples.

```
$ oneimage create -d 153 --type OS --name test_standalone --path /tmp/tinycore-2.1-
↪x86.vmdk --driver vcenter --description "Upload test"
ID: 134
```

The command will return the image ID. While the image is being uploaded the Image status will be LOCKED. You can check later if the status has changed to READY or ERROR.

Using Sunstone

You have to select the IMAGE datastore where you want that file to be uploaded and specify if you want the image to be persistent or non-persistent when used by a Virtual Machine.

When you upload a VMDK file you can assign the image a type either Operating System Image or Generic Storage Datablock.

In the following example we're uploading a tar gz file containing a flat file and vmdk descriptor, using our browser. OpenNebula will upload the file to a temporary location, untar and uncompress that file and upload its contents to the vCenter datastore you've chosen.

The screenshot shows the 'Create Image' wizard in Sunstone. The 'Name' field contains 'test_upload_vmdk'. The 'Description' field contains 'Trying to upload a VMDK tarred and zipped containing a flat file and a vmdk file.'. The 'Type' dropdown is set to 'Generic storage datablock'. The 'Datastore' dropdown is set to '153: nfs [vcenter:centner65-2 - Datacenter] (IMG)'. There is a checkbox for 'This image is persistent' which is currently unchecked. Under the 'Image location' section, the 'Upload' radio button is selected, and the file 'Test.tar.gz' is listed below it.

Warning: If your Sunstone server is not located behind an Apache or NGINX server with Passenger, you may receive an error with the message **Cannot contact server. Is it running or reachable?** if the upload operation takes more than 30 seconds to finish. In that case you may refresh the Images window and you'll see that the new image is in the LOCKED state but the upload operation is still on course, so check it again later to see if the Image is in the READY state or ERROR.

Click on the Create button to start the file uploading process.

While the image is uploaded the status will be LOCKED, you can refresh the Images tab later to check if the status is READY to use or ERROR.

132	test_upload_vmdk	oneadmin	oneadmin	nfs [vcenter:centner65-2 - Datacenter] (IMG)	DATABLOCK	READY	0
-----	------------------	----------	----------	--	-----------	-------	---

6.3.6 Upload ISO files

You can upload ISO files that can be used as CDROM images that can be attached to Virtual Machines.

Note: CDROM images files can only be attached to a Virtual Machine when it's in the POWEROFF state as the ISO files is attached to the Virtual Machine as an IDE CD-ROM drive which is not a hot-pluggable devices.

The ISO file can be uploaded in two ways:

- Adding the file from your web browser or
- Specify the path using an URL.

Using the CLI

You can use the oneimage CLI command. Here's an example where we want to upload a standalone vmdk file to the IMAGE datastore with ID 154.

We specify the vcenter driver, type will be CDROM, a name and a description.

```
$ oneimage create -d 153 --name test_iso_file --type CDROM --path http://
↳ tinycorelinux.net/8.x/x86/release/Core-current.iso --driver vcenter --description
↳ "Upload ISO test"
ID: 135
```

The command will return the image ID. While the ISO image is being uploaded the Image status will be LOCKED. You can check later if the status has changed to READY or ERROR.

Using Sunstone

In the following example we're using an URL in Internet. OpenNebula will download the ISO file to a temporary file and then upload it to the vCenter datastore you've chosen.

The screenshot shows the 'Create Image' wizard in Sunstone. It has two tabs: 'Wizard' (selected) and 'Advanced'. The 'Name' field contains 'test_upload'. The 'Description' field contains 'A Tiny Core Linux ISO file.'. The 'Type' dropdown is set to 'Readonly CD-ROM'. The 'Datastore' dropdown is set to '153:nfs [vcentercenter65-2-Datacenter] (IMG)'. Under 'Image location', the 'Path in OpenNebula server' radio button is selected, and the 'Path' field contains 'http://tinycorelinux.net/8.x/x86/release/Core-current.iso'. There are 'Reset' and 'Create' buttons at the top left, and 'Wizard' and 'Advanced' tabs at the top right.

Warning: If your Sunstone server is not located behind an Apache or NGINX server with Passenger, you may receive an error with the message **Cannot contact server. Is it running or reachable?** if the upload operation takes more than 30 seconds to finish. In that case you may refresh the Images window and you'll see that the new image is in the LOCKED state but the upload operation is still on course, so check it again later to see if the Image is in the READY state or ERROR.

Click on the Create button to start the file uploading process.

While the image is uploaded the status will be LOCKED, you can refresh the Images tab later to check if the status is READY to use or ERROR.

```
131 test_upload_cdrom oneadmin oneadmin nfs [vcentercenter65-2-Datacenter] (IMG) CDROM READY 0
```

6.3.7 Create empty datablocks

You can easily create empty VMDK datablocks from OpenNebula.

In Sunstone you can follow these steps:

- Give the datablock a name. A description is optional.
- Select Generic storage datablock in the drop-down Type menu.
- Choose the IMAGE datastore where you want OpenNebula to create the empty datablock.

- Select Empty disk image.
- Specify the size in MB of the datablock.
- Select the disk type (Optional). You have a full list of disk types in the VCENTER_DISK_TYPE attribute description explained in the Configuration section.
- Select the bus adapter (Optional). You have a full list of controller types in the VCENTER_ADAPTER_TYPE attribute description explained in the Configuration section.

Finally click on Create.

While the VMDK file is created in the datastore the Image status will be LOCKED, you can refresh the Images tab later to check if the status is READY to use or ERROR.

Note: If you don't specify a disk type and/or bus adapter controller type the default values contained in the `/etc/one/vcenter_driver.default` file are applied. You have more information [here](#).

6.3.8 Configuration

In order to create a OpenNebula vCenter datastore that represents a vCenter VMFS datastore, a new OpenNebula datastore needs to be created with the following attributes. The `onevcenter` import tool creates a datastore representation with the required attributes.

Attribute	Description
DS_MAD	Must be set to <code>vcenter</code> if TYPE is SYSTEM_DS
TM_MAD	Must be set <code>vcenter</code>
TYPE	Must be set to SYSTEM_DS or IMAGE_DS
VCENTER_DEFAULT_ADAPTER	Default adapter type used by virtual disks to plug inherited to VMs for the images in the datastore. It is inherited by images and can be overwritten if specified explicitly in the image. Possible values (careful with the case): <code>lsiLogic</code> , <code>ide</code> , <code>busLogic</code> . More information in the VMware documentation . Known as “Bus adapter controller” in Sunstone.
VCENTER_DISK_TYPE	Type of disk to be created when a DATABLOCK is requested. This value is inherited from the datastore to the image but can be explicitly overwritten. The type of disk has implications on performance and occupied space. Values (careful with the case): <code>delta</code> , <code>eagerZeroedThick</code> , <code>flatMonolithic</code> , <code>preallocated</code> , <code>raw</code> , <code>rdm</code> , <code>rdmp</code> , <code>seSparse</code> , <code>sparse2Gb</code> , <code>sparseMonolithic</code> , <code>thick</code> , <code>thick2Gb</code> , <code>thin</code> . More information in the VMware documentation . Known as “Disk Provisioning Type” in Sunstone.
VCENTER_DATASTORE	Managed Object Reference of the vCenter datastore. Please visit the Managed Object Reference section to know more about these references.
VCENTER_DATACENTER	Managed Object Reference of the vCenter datacenter. Please visit the Managed Object Reference section to know more about these references.
VCENTER_INSTANCE	The vCenter instance ID. Please visit the Managed Object Reference section to know more about these references.
VCENTER_HOST	Hostname or IP of the vCenter host
VCENTER_USER	Name of the vCenter user.
VCENTER_PASSWORD	Password of the vCenter user. It’s encrypted when the datastore template is updated using the secret stored in the <code>/var/lib/one/.one/one_key</code> an
VCENTER_IMAGES_FOLDER	(Optional) Specifies what folder under the root directory of the datastore will host persistent and non-persistent images e.g <code>one</code>
VCENTER_DISKS_FOLDER	(Optional) Specifies what folder under the root directory of the datastore will host the volatile disks

All OpenNebula datastores are actively monitoring, and the scheduler will refuse to deploy a VM onto a vCenter datastore with insufficient free space.

6.4 Datastore clusters with Storage DRS

Thanks to OpenNebula’s scheduler, you can manage your datastores clusters with load distribution but you may already be using vCenter’s [Storage DRS](#) capabilities. Storage DRS allows you to manage the aggregated resources of a datastore cluster. If you’re using Storage DRS, OpenNebula can delegate the decision of selecting a datastore to the Storage DRS cluster (SDRS) but as this behavior interferes with OpenNebula’s scheduler and vSphere’s API impose some restrictions, there will be some limitations in StorageDRS support in OpenNebula.

When you import a SDRS cluster using `onevcenter` or Sunstone:

- The cluster will be imported as a SYSTEM datastore only. vSphere’s API does not provide a way to upload or create files directly into the SDRS cluster so it can’t be used as an IMAGE datastore.
- OpenNebula detects the datastores grouped by the SDRS cluster so you can still import those datastores as both IMAGE and SYSTEM datastores.
- Non-persistent images are not supported by a SDRS as vSphere’s API does not provide a way to create, copy or delete files to a SDRS cluster as a whole, however you can use persistent and volatile images with the VMs backed by your SDRS.
- Linked clones over SDRS are not supported by OpenNebula, so when a VM clone is created a full clone is performed.

In order to delegate the datastore selection to the SDRS cluster you must inform OpenNebula's scheduler that you want to use specifically the SYSTEM datastore representing the storage cluster. You can edit a VM template and add the following expression: `ID=DATASTORE_ID` to the attribute `SCHED_DS_REQUIREMENTS`, where `DATASTORE_ID` must be replaced with the numeric id assigned by OpenNebula to the datastore. Thanks to this attribute OpenNebula will always use this datastore when deploying a VM. There's an alternative if you don't want to use `SCHED_DS_REQUIREMENTS` if you have several SYSTEM datastores in the same OpenNebula cluster associated to the vCenter cluster, you can disable all SYSTEM datastores but the one that represents your StorageDRS cluster as the scheduler will not use disabled datastores.

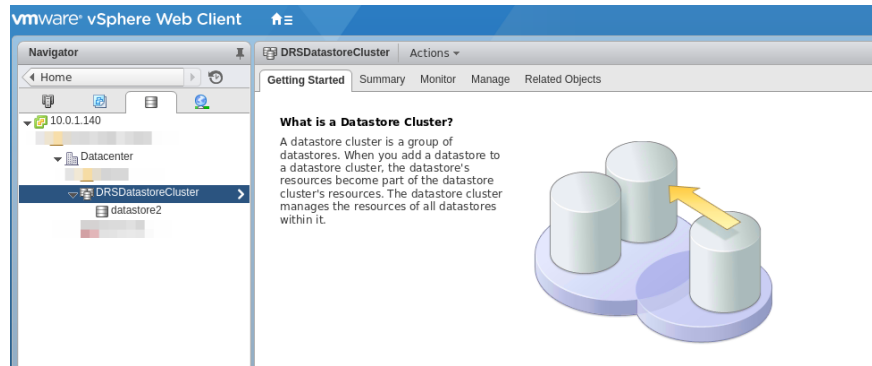

6.5 Marketplace with vCenter Datastores

The vCenter datastores are compatible with OpenNebula HTTP and S3 marketplaces. It's necessary a generic VM Template. More information about OpenNebula marketplaces can be found [here](#).

6.6 Tuning and Extending

Drivers can be easily customized please refer to the specific guide for each datastore driver or to the Storage subsystem developer's guide.

However you may find the files you need to modify here:

- `/var/lib/one/remotes/datastore/vcenter`
- `/var/lib/one/remotes/tm/vcenter`

6.7 vCenter Networking Overview

Virtual Networks from vCenter can be represented using OpenNebula virtual networks, where a one-to-one relationship exists between an OpenNebula's virtual network and a vSphere's port group. When adding NICs in a VM template or when attaching a NIC (hot-plugging) to a running VM in OpenNebula, a network interface can be attached to an OpenNebula's Virtual Network.

OpenNebula can consume port groups or create port groups.

In vSphere's terminology, a port group can be seen as a template for creating virtual ports with particular sets of specifications such as VLAN tagging. The VM's network interfaces connect to vSphere's virtual switches through port groups. vSphere provides two types of port groups:

- Port Group (or Standard Port Group). The port group is connected to a vSphere Standard Switch.
- Distributed Port Group. The port group is connected to a vSphere Distributed Switch.

According to VMWare's [vSphere Networking Guide](#) we have two virtual switches types:

- vSphere Standard Switch. It works much like a physical Ethernet switch. A vSphere standard switch can be connected to physical switches by using physical Ethernet adapters, also referred to as uplink adapters, to join virtual networks with physical networks. You create and configure the virtual standard switch on each ESXi host where you want that virtual switch to be available.
- vSphere Distributed Switch. It acts as a single switch across all associated hosts in a datacenter to provide centralized provisioning, administration, and monitoring of virtual networks. You configure a vSphere distributed switch on the vCenter Server system and the configuration is populated across all hosts that are associated with the switch. This lets virtual machines to maintain consistent network configuration as they migrate across multiple hosts.

Note: The vSphere Distributed Switch is only available for VMWare's vSphere Enterprise Plus licence.

If you want to associate OpenNebula's virtual networks to vSphere's port groups:

- You can create the port groups using vSphere's Web Client and then consume them using the import tools or,
- You can create port groups directly from OpenNebula using a virtual network definition, adding the attribute `VN_MAD=vcenter` to the network template and letting OpenNebula create the network elements for you.

6.8 Consuming existing vCenter port groups

Existing vCenter networks can be represented using OpenNebula Virtual Networks, taking into account that the BRIDGE attribute of the Virtual Network needs to match the name of the Network (port group) defined in vCenter.

OpenNebula supports both "Port Groups" and "Distributed Port Groups", and as such can **create or consume** any vCenter defined network resource.

Networks can be created using vSphere's web client, with any specific configuration like for instance VLANs. OpenNebula will use these networks with the defined characteristics representing them as Virtual Networks. OpenNebula additionally can handle on top of these networks three types of Address Ranges: Ethernet, IPv4 and IPv6.

vCenter VM Templates can define their own NICs, and OpenNebula will manage them and its information (IP, MAC, etc) is known by OpenNebula. Any NIC present in the OpenNebula VM Template, or added through the `attach_nic` operation, will be handled by OpenNebula, and as such it is subject to be detached.

OpenNebula Virtual Networks which consume existing port groups will have the attribute `VN_MAD=dummy`.

You can easily consume vCenter networks using the import tools as explained in the [Importing vCenter Networks](#) section.

6.9 Creating Port Groups from OpenNebula

OpenNebula can create a vCenter network from a Virtual Network template if the vCenter network driver is used (thanks to the attribute `VN_MAD=vcenter`).

This is the workflow when OpenNebula needs to create a vCenter network:

1. Enable the VNET hooks in OpenNebula's `oned` configuration file.
2. Create a new OpenNebula Virtual Network template. Add the required attributes to the template including the OpenNebula's Host ID which represents the vCenter cluster where the network elements will be created.

3. When the Virtual Network is created, a hook will create the network elements required on each ESX host that are members of the specified vCenter cluster.
4. The Virtual Network will be automatically assigned to the OpenNebula cluster which includes the vCenter cluster represented as an OpenNebula host.
5. The hooks works asynchronously so you may have to refresh the Virtual Network information until you find the VCENTER_NET_STATE attribute. If it completes the actions successfully that attribute will be set to READY and hence you can use it from VMs and templates. If the hook fails VCENTER_NET_STATE will be set to ERROR and the VCENTER_NET_ERROR attribute will offer more information.

6.9.1 Enabling the VNET hooks

If you want to use the vcenter network driver you must uncomment or add the following lines to the oned.conf configuration file:

```
VNET_HOOK = [
  name      = "vcenter_net_create",
  on        = "CREATE",
  command   = "vcenter/create_vcenter_net.rb",
  arguments = "$ID $TEMPLATE"]

VNET_HOOK = [
  name      = "vcenter_net_delete",
  on        = "REMOVE",
  command   = "vcenter/delete_vcenter_net.rb",
  arguments = "$ID $TEMPLATE"]
```

Note: If you don't want OpenNebula to remove the vCenter network elements when a Virtual Network is deleted, remove the VNET_HOOK associated to the REMOVE action.

Warning: You'll have to restart the oned service so these changes are applied.

This hooks are the scripts responsible of creating the vCenter network elements and deleting them when the OpenNebula Virtual Network template is deleted.

6.9.2 Hooks information

The creation hook performs the following actions for each ESX host found in the cluster assigned to the template if a standard port group has been chosen:

- If the port group does not exist, it will create it.
- If the port group or switch name exist, **they won't be updated** ignoring new attributes to protect you from unexpected changes that may break your connectivity.

The creation hook performs the following actions if a distributed port group has been chosen:

- OpenNebula creates the distributed switch if it doesn't exist. If the switch exists, it's not updated ignoring any attribute you've set.
- OpenNebula creates the distributed port group if it doesn't exist in the datacenter associated with the vCenter cluster. If the distributed port group already exists **it won't be updated** to protect you from unexpected changes.

- For each ESX host found in the cluster assigned to the template, it adds the ESX host to the distributed switch.

Creation hook is asynchronous which means that you'll have to check if the `VCENTER_NET_STATE` attribute has been set. Once the hook finishes you'll find the `VCENTER_NET_STATE` either with the `READY` value or the `ERROR` value. If an error was found you can check what was wrong.

Here's a screenshot once the hook has finished and the network is ready:

vCenter information	
VCENTER_INSTANCE_ID	8C3875CD-275B-4718-BFE4-99739AE06F78
VCENTER_NET_ERROR	
VCENTER_NET_REF	network-1131
VCENTER_NET_STATE	READY
VCENTER_ONE_HOST_ID	66
VCENTER_PORTGROUP_TYPE	Port Group
VCENTER_SWITCH_NAME	

The removal hook performs the following actions:

- OpenNebula contacts with the vCenter server.
- For each ESX host found in the vCenter cluster assigned to the template, it tries to remove both the port group and the switch. If the switch has no more port groups left then the switch will be removed too.

In this case the hook is also asynchronous. If you want to know if it succeeded or failed you can run the following command:

```
grep EXECUTE /var/log/one/oned.log | grep vcenter_net_delete
```

If the script failed, you can check the lines before `EXECUTE FAILURE` in the `/var/log/one/oned.log` to get more information on the failure. If the removal hook fails you may have to check your vCenter server and delete those resources that could not be deleted automatically.

Warning: If a port group or switch is in use e.g a VM is running and have a NIC attached to that port group the remove operation will fail so please ensure that you have no VMs or templates using that port group before trying to remove the Virtual Network representation.

6.9.3 vCenter Network attributes

You can easily create a Virtual Network definition from Sunstone but you can also create a template and apply it with the `onevnet` command. Here's the table with the attributes that must be added inside a `TEMPLATE` section:

Attribute	Type	Mandatory	Description
VN_MAD	string	Yes	Must be set to <code>vcenter</code>
BRIDGE	string	Yes	It's the port group name.
PHYDEV	string	No	If you want to assign uplinks to your switch you can specify the names of the physical network interface cards of your ESXi hosts that will be used. You can use several physical NIC names using a comma between them e.g <code>vmnic0,vmnic1</code> . Note that two switches cannot share the same physical nics and that you must be sure that the same physical interface name exists and it's available for every ESX host in the cluster. This attribute will be ignored if the switch already exists.
VCENTER_PORTGROUP	string	Yes	There are two possible values Port Group and Distributed Port Group. Port Group means a Standard Port Group
VCENTER_HOST_ID	integer	Yes	The OpenNebula host id which represents the vCenter cluster where the network will be created.
VCENTER_SWITCH_NAME	string	Yes	The name of the virtual switch where the port group will be created. If the vcenter switch already exists it won't update it to avoid accidental connectivity issues
VCENTER_SWITCH_PORTS	integer	No	The number of ports assigned to a virtual standard switch or the number of uplink ports assigned to the Uplink port group in a Distributed Virtual Switch. This attribute will be ignored if the switch already exists.
MTU	integer	No	The maximum transmission unit setting for the virtual switch. This attribute will be ignored if the switch already exists.
VLAN_ID	integer	Yes (unless <code>AUTOMATIC_VLAN_ID</code>)	The VLAN ID, will be generated if not defined and <code>AUTOMATIC_VLAN_ID</code> is set to YES
AUTOMATIC_VLAN_ID	boolean	Yes (unless <code>VLAN_ID</code>)	Mandatory and must be set to YES if <code>VLAN_ID</code> hasn't been defined so OpenNebula created a VLAN ID automatically
VCENTER_VNET_DELETE_HOOK	boolean	No	This attribute is a protection mechanism to prevent accidental deletion with <code>vcenter_vnet_delete</code> hook

6.9.4 Settings applied to virtual switches and port groups created by OpenNebula

OpenNebula uses the following values when creating virtual switches and port groups in vCenter according to what the vSphere's Web Client uses in the same operations:

- VLAN ID is set to 0, which means that no VLANs are used.
- MTU value is set to 1500.

Standard port groups created by OpenNebula have the following settings:

- Number of ports is set to Elastic. According to VMWare's documentation, the Elastic mode is used to ensure efficient use of resources on ESXi hosts where the ports of virtual switches are dynamically scaled up and down. In any case, the default port number for standard switches is 128.
- Security - Promiscuous mode is set to Reject, which means that the virtual network adapter only receives frames that are meant for it.
- Security - MAC Address Changes is set to Accept, so the ESXi host accepts requests to change the effective MAC address to other than the initial MAC address.

- Security - Forged transmits is set to Accept, which means that the ESXi host does not compare source and effective MAC addresses.
- Traffic Shaping policies to control the bandwidth and burst size on a port group are disabled. You can still set QoS for each NIC in the template.
- Physical NICs. The physical NICs used as uplinks are bridged in a bond bridge with teaming capabilities.

Distributed port groups created by OpenNebula have the following settings:

- Number of ports is set to Elastic. According to VMWare's documentation, the Elastic mode is used to ensure efficient use of resources on ESXi hosts where the ports of virtual switches are dynamically scaled up and down. The default port number for distributed switches is 8.
- Static binding. When you connect a virtual machine to a distributed port group, a port is immediately assigned and reserved for it, guaranteeing connectivity at all times. The port is disconnected only when the virtual machine is removed from the port group.
- Auto expand is enabled. When the port group is about to run out of ports, the port group is expanded automatically by a small predefined margin.
- Early Bindind is enabled. A free DistributedVirtualPort will be selected to assign to a Virtual Machine when the Virtual Machine is reconfigured to connect to the port group.

6.9.5 OpenNebula Virtual Network template (Sunstone)

In this section we will explain how a Virtual Network definition can be created using the Sunstone user interface, and we will introduce the available attributes for the vcenter network driver.

The first step requires you to introduce the virtual network's name:

The screenshot shows the 'Create Virtual Network' form in Sunstone. At the top, there are navigation buttons: a back arrow, a 'Reset' button, and a 'Create' button. Below these are tabs for 'General', 'Conf', 'Addresses', 'Security', 'QoS', and 'Context'. The 'General' tab is active. Under 'Name', the text 'vcenter_network_test' is entered. Under 'Description', there is an empty text area.

In the Conf tab, select vCenter from the Network Mode menu, so the vcenter network driver is used (the `VN_MAD=vcenter` attribute will be added to OpenNebula's template). The Bridge name will be the name of the port group, and by default it's the name of the Virtual Network but you can choose a different port group name.

The screenshot shows the 'Conf' tab in Sunstone. A dropdown menu for 'Network mode' is open, displaying several options. The 'vCenter' option is highlighted with a blue background. A red rectangular box is drawn around the entire dropdown menu. Other options visible include 'Bridged', 'Bridged & Security Groups', 'Bridged & ebttables VLAN', '802.1Q', 'VXLAN', 'Open vSwitch', and 'Custom'.

Once you've selected the vCenter network mode, Sunstone will show several network attributes that can be defined.

vSphere standard switches or distributed switches with port groups. Security Groups are not applied.

VLAN ID: Automatic VLAN ID (dropdown)

Physical device @: (text input)

MTU of the interface: (text input)

Switch name: (text input)

Number of ports: (text input)

Port group type: Port group (dropdown)

OpenNebula's Host ID: Please select (dropdown)

You have more information about these attributes in the *vCenter Network attributes* section, but we'll comment some of them:

OpenNebula Host's ID

In order to create a Virtual Network using the vcenter driver we must select which vCenter cluster, represented as an OpenNebula host, this virtual network will be associated to. OpenNebula will act on each of the ESX hosts which are members of the vCenter cluster.

Physical device

If you want to assign uplinks to your switch you can specify the names of the physical network interface cards of your ESXi hosts that will be used. You can use several physical NIC names using a comma between them e.g vmnic0,vmnic1. Note that you must check that two switches cannot share the same physical NIC and that you must be sure that the same physical interface name exists and it's available for every ESX host in the cluster.

Let's see an example. If you want to create a port group in a new virtual switch, we'll first check what physical adapters are free and unassigned in the hosts of my vCenter cluster. I've two hosts in my cluster:

In my first host, the vmnic1 adapter is free and is not assigned to any vSwitch:

Settings | Storage | **Networking** | Alarm Definitions | Tags | Permissions

Virtual switches
VMkernel adapters
Physical adapters
TCP/IP configuration
Advanced

Physical adapters

Device	Actual Speed	Configured Speed	Switch	MAC Address
Intel Corporation 82576 Gigabit Network Connection				
vmnic0	1000 Mb	Auto negotiate	vSwitch0	78:e3:b5:11:ab:4a
vmnic1	1000 Mb	Auto negotiate	--	78:e3:b5:11:ab:4b

In my second host, the vmnic1, vmnic2 and vmnic3 interfaces are free:

Virtual switches
VMkernel adapters
Physical adapters
TCP/IP configuration
Advanced

Physical adapters

Device	Actual Speed	Configured Speed	Switch	MAC Address
Intel Corporation 82571EB Gigabit Ethernet Controller				
vmnic2	Down	Auto negotiate	--	00:23:8b:ce:a8:7e
vmnic3	Down	Auto negotiate	--	00:23:8b:ce:a8:7f
Intel Corporation 80003ES2LAN Gigabit Ethernet Controller				
vmnic0	1000 Mb	Auto negotiate	vSwitch0	00:23:8b:ce:a8:7c
vmnic1	Down	Auto negotiate	--	00:23:8b:ce:a8:7d

So if I want to specify an uplink, the only adapter that I could use in both ESX hosts would be **vmnic1** and OpenNebula will create the switches and uplinks as needed:

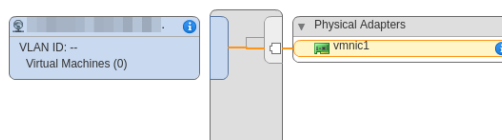

Number of ports

This attribute is optional. With this attribute we can specify the number of ports that the virtual switch is configured to use. If you set a value here please make sure that you know and understand the [maximums supported by your vSphere platform](#).

VLAN ID

This attribute is optional. You can set a manual VLAN ID, force OpenNebula to generate an automatic VLAN ID or set that no VLANs are used. This value will be assigned to the VLAN_ID attribute.

Address Ranges

In order to create your Virtual Network you must also add an Address Range in the Addresses tab. Please visit the Virtual Network Definition section.

6.9.6 Limitations

OpenNebula won't sync ESX hosts. OpenNebula won't create or delete port groups or switches on ESX hosts that are added/removed after the Virtual Network was created. For example, if you're using vMotion and DPM and an ESX host is powered on, that ESX host won't have the switch and/or port group that was created by OpenNebula hence a VM cannot be migrated to that host.

Virtual Network Update is not supported. If you update a Virtual Network definition, OpenNebula won't update the attributes in existing port groups or switches so you should remove the virtual network and create a new one with the new attributes.

Security groups. Security Groups are not supported by the vSphere Switch mode.

Network alias. It is possible to use network interface alias with vCenter, however if you attach an alias when the vm is running the action will take action on the next reboot (OpenNebula deploy). If you do not want to reboot the machine you can manually execute the next command on the machine prompt:

```
$ /usr/sbin/one-contextd all reconfigure
```

6.10 Network monitoring

OpenNebula gathers network monitoring info for each VM. Real-time data is retrieved from vCenter thanks to the Performance Manager which collects data every 20 seconds and maintains it for one hour. Real-time samples are used so no changes have to be applied to vCenter's Statistics settings. Network metrics for transmitted and received traffic are provided as an average using KB/s unit.

The graphs provided by Sunstone are different from those found in vCenter under the Monitor -> Performance Tab when selecting Realtime in the Time Range drop-down menu or in the Advanced view selecting the Network View. The reason is that Sunstone uses polling time as time reference while vCenter uses sample time on their graphs, so an approximation to the real values aggregating vCenter's samples between polls is needed. As a result, upload and download peaks will be different in value and different peaks between polls won't be depicted. Sunstone's graphs will provide a useful information about networking behaviour which can be examined on vCenter later with greater detail.

OPEN CLOUD HOST SETUP

7.1 Overview

The Hosts are servers with a hypervisor installed (KVM or LXD) which execute the running Virtual Machines. These Hosts are managed by the KVM or LXD Driver, which will perform the actions needed to manage the VM and its life-cycle. This chapter analyses the KVM or LXD driver in detail, and will give you, amongst other things, the tools to configure and add KVM or LXD hosts into the OpenNebula Cloud.

7.1.1 How Should I Read This Chapter

Before reading this chapter, you should have already installed your *Frontend*, the *KVM Hosts* and/or *LXD Hosts* and have an OpenNebula cloud up and running with at least one virtualization node.

This chapter will focus on the configuration options for the Hosts.

- Read the *KVM driver* section in order to understand the procedure of configuring and managing KVM Hosts.
- Read the *LXD driver* section in order to understand the procedure of configuring and managing LXD Hosts.
- In the *Monitoring* section, you can find information about how OpenNebula is monitoring its Hosts and Virtual Machines, and changes you can make in the configuration of that subsystem.
- You can read this section if you are interested in performing *PCI Passthrough*.

After reading this chapter, you should read the *Open Cloud Storage* chapter.

7.1.2 Hypervisor Compatibility

This chapter applies to KVM and LXD.

Follow the *vCenter Node* section for a similar guide for vCenter.

7.2 KVM Driver

KVM (Kernel-based Virtual Machine) is the hypervisor for OpenNebula's *Open Cloud Architecture*. KVM is a complete virtualization system for Linux. It offers full virtualization, where each Virtual Machine interacts with its own virtualized hardware. This guide describes the use of the KVM with OpenNebula.

7.2.1 Requirements

The Hosts will need a CPU with Intel VT or AMD's AMD-V features, in order to support virtualization. KVM's [Preparing to use KVM](#) guide will clarify any doubts you may have regarding if your hardware supports KVM.

KVM will be installed and configured after following the [KVM Host Installation](#) section.

7.2.2 Considerations & Limitations

Try to use *virtio* whenever possible, both for networks and disks. Using emulated hardware, both for networks and disks, will have an impact in performance and will not expose all the available functionality. For instance, if you don't use *virtio* for the disk drivers, you will not be able to exceed a small number of devices connected to the controller, meaning that you have a limit when attaching disks, and it will not work while the VM is running (live disk-attach).

7.2.3 Configuration

KVM Configuration

The OpenNebula packages will configure KVM automatically, therefore you don't need to take any extra steps.

Drivers

The KVM driver is enabled by default in OpenNebula:

```

#-----
# KVM Virtualization Driver Manager Configuration
# -r number of retries when monitoring a host
# -t number of threads, i.e. number of hosts monitored at the same time
# -l <actions[=command_name]> actions executed locally, command can be
# overridden for each action.
# Valid actions: deploy, shutdown, cancel, save, restore, migrate, poll
# An example: "-l migrate=migrate_local,save"
# -p more than one action per host in parallel, needs support from hypervisor
# -s <shell> to execute remote commands, bash by default
#
# Note: You can use type = "qemu" to use qemu emulated guests, e.g. if your
# CPU does not have virtualization extensions or use nested Qemu-KVM hosts
#-----
VM_MAD = [
    NAME           = "kvm",
    SUNSTONE_NAME  = "KVM",
    EXECUTABLE     = "one_vmm_exec",
    ARGUMENTS      = "-t 15 -r 0 kvm",
    DEFAULT        = "vmm_exec/vmm_exec_kvm.conf",
    TYPE           = "kvm",
    KEEP_SNAPSHOTS= "no",
    IMPORTED_VMS_ACTIONS = "terminate, terminate-hard, hold, release, suspend,
        resume, delete, reboot, reboot-hard, resched, unresched, disk-attach,
        disk-detach, nic-attach, nic-detach, snap-create, snap-delete"
]

```

The configuration parameters: `-r`, `-t`, `-l`, `-p` and `-s` are already preconfigured with sane defaults. If you change them you will need to restart OpenNebula.

Read the Virtual Machine Drivers Reference for more information about these parameters, and how to customize and extend the drivers.

Driver Defaults

There are some attributes required for KVM to boot a VM. You can set a suitable defaults for them so, all the VMs get needed values. These attributes are set in `/etc/one/vmm_exec/vmm_exec_kvm.conf`. The following can be set for KVM:

- **EMULATOR:** path to the kvm executable.
- **OS:** attributes `KERNEL`, `INITRD`, `BOOT`, `ROOT`, `KERNEL_CMD`, `MACHINE` and `ARCH`.
- **VCPU**
- **FEATURES:** attributes `ACPI`, `PAE`.
- **DISK:** attributes `DRIVER` and `CACHE`. All disks will use that driver and caching algorithm.
- **NIC:** attribute `FILTER`.
- **RAW:** to add libvirt attributes to the domain XML file.
- **HYPERV:** to enable hyperv extensions.
- **SPICE:** to add default devices for SPICE.

For example:

```
OS      = [ ARCH = "x86_64" ]
FEATURES = [ PAE = "no", ACPI = "yes", APIC = "no", HYPERV = "no", GUEST_AGENT = "no",
↳ ]
DISK     = [ DRIVER = "raw" , CACHE = "none"]
HYPERV_OPTIONS="<relaxed state='on'/><vapic state='on'/><spinlocks state='on' retries=
↳ '4096'/>"
SPICE_OPTIONS="
  <video>
    <model type='qxl' heads='1'/>
  </video>
  <sound model='ich6' />
  <channel type='spicevmc'>
    <target type='virtio' name='com.redhat.spice.0'/>
  </channel>
  <redirdev bus='usb' type='spicevmc'/>
  <redirdev bus='usb' type='spicevmc'/>
  <redirdev bus='usb' type='spicevmc'/>"
```

Note: These values can be overridden in the VM Template

Live-Migration for Other Cache settings

In case you are using disks with a cache setting different to none you may have problems with live migration depending on the libvirt version. You can enable the migration adding the `--unsafe` parameter to the `virsh` command. The file to change is `/var/lib/one/remotes/etc/vmm/kvm/kvmrc`. Uncomment the following line, and execute `onehost sync --force` afterwards:

```
MIGRATE_OPTIONS=--unsafe
```

Configure the Timeouts (Optional)

Optionally, you can set a timeout for the VM Shutdown operation can be set up. This feature is useful when a VM gets stuck in Shutdown (or simply does not notice the shutdown command). By default, after the timeout time the VM will return to Running state but is can also be configured so the VM is destroyed after the grace time. This is configured in `/var/lib/one/etc/remotes/vmm/kvm/kvmrc`:

```
# Seconds to wait after shutdown until timeout
export SHUTDOWN_TIMEOUT=300

# Uncomment this line to force VM cancellation after shutdown timeout
#export FORCE_DESTROY=yes
```

Working with cgroups (Optional)

Cgroups is a kernel feature that allows to control the number of resources allocated to a given process (among other things). It can be used to enforce the amount of CPU assigned to a VM, as defined in its OpenNebula template (i.e., a VM with CPU=0.5 will get half of the physical CPU cycles than a VM with CPU=1.0). The cgroups are configured **on each hypervisor host (where required), not on the front-end.**

Note: In current operating systems running the systemd, the cgroups are enabled and used by libvirt/KVM automatically. No configuration is necessary. The tool `lscgroup` (included in distribution package `libcgroup-tools` on RHEL/CentOS or `cgroup-tools` on Debian/Ubuntu) can be used to check the cgroups state on your system. The cgroups aren't available if you get an error output of the tool, e.g.:

```
$ lscgroup
cgroups can't be listed: Cgroup is not mounted
```

Follow the documentation of your operating system to enable and configure the cgroups.

Cgroups can be used to limit the overall amount of physical RAM that the VMs can use, so you can leave always a fraction to the host OS. In this case, you may want to set also the `RESERVED_MEM` parameter in host or cluster templates.

OpenNebula automatically generates a number of CPU shares proportional to the CPU attribute in the VM template. For example, the host running 2 VMs (ID 73 and 74, with CPU=0.5 and CPU=1) should be configured following way:

```
/sys/fs/cgroup/cpu,cpuacct/machine.slice/
|-- cgroup.clone_children
|-- cgroup.event_control
...
|-- cpu.shares
|-- cpu.stat
|-- machine-gemu\x2d1\x2done\x2d73.scope
|   |-- cgroup.clone_children
|   |-- cgroup.event_control
|   |-- cgroup.procs
|   |-- cpu.shares
|   ...
|   `-- vcpu0
```

(continues on next page)

(continued from previous page)

```

|         |-- cgroup.clone_children
|         ...
|-- machine-qemu\x2d2\x2done\x2d74.scope
|     |-- cgroup.clone_children
|     |-- cgroup.event_control
|     |-- cgroup.procs
|     |-- cpu.shares
|     ...
|     `-- vcpu0
|         |-- cgroup.clone_children
|         ...
|-- notify_on_release
`-- tasks

```

with the CPU shares for each VM:

```

$ cat '/sys/fs/cgroup/cpu,cpuacct/machine.slice/machine-qemu\x2d1\x2done\x2d73.scope/
↳cpu.shares'
512
$ cat '/sys/fs/cgroup/cpu,cpuacct/machine.slice/machine-qemu\x2d2\x2done\x2d74.scope/
↳cpu.shares'
1024

```

Note: The cgroups (directory) layout can be different based on your operating system and configuration. The [libvirt documentation](#) describes all the cases and a way the cgroups are managed by libvirt/KVM.

VCPUs are not pinned so most probably the virtual machine's process will be changing the physical cores it is using. In an ideal case where the VM is alone in the physical host the total amount of CPU consumed will be equal to VCPU plus any overhead of virtualization (for example networking). In case there are more VMs in that physical node and is heavily used then the VMs will compete for physical CPU time. In this case, the cgroups will provide a fair share of CPU time between VMs (a VM with CPU=2 will get double the time as a VM with CPU=1).

In case you are not overcommitting (CPU=VCPU) all the virtual CPUs will have one physical CPU (even if it's not pinned) so they could consume the number of VCPU assigned minus the virtualization overhead and any process running in the host OS.

7.2.4 Usage

KVM Specific Attributes

The following are template attributes specific to KVM, please refer to the template reference documentation for a complete list of the attributes supported to define a VM.

DISK

- **TYPE:** This attribute defines the type of the media to be exposed to the VM, possible values are: `disk` (default), `cdrom` or `floppy`. This attribute corresponds to the `media` option of the `-driver` argument of the `kvm` command.
- **DRIVER:** specifies the format of the disk image; possible values are `raw`, `qcow2`... This attribute corresponds to the `format` option of the `-driver` argument of the `kvm` command.

- **CACHE:** specifies the optional cache mechanism, possible values are `default`, `none`, `writethrough` and `writeback`.
- **IO:** set IO policy possible values are `threads` and `native`.
- **DISCARD:** controls what to do with trim commands, the options are `ignore` or `unmap`. It can only be used with `virtio-scsi`.
- **IO Throttling support:** You can limit **TOTAL/READ/WRITE** throughput or **IOPS**. Also burst control for this IO operations can be set for each disk. See the reference guide for the attribute names and purpose.

NIC

- **TARGET:** name for the tun device created for the VM. It corresponds to the `ifname` option of the `'-net'` argument of the `kvm` command.
- **SCRIPT:** name of a shell script to be executed after creating the tun device for the VM. It corresponds to the `script` option of the `'-net'` argument of the `kvm` command.
- **QoS to control the network traffic.** We can define different kind of controls over network traffic:
 - `INBOUND_AVG_BW`
 - `INBOUND_PEAK_BW`
 - `INBOUND_PEAK_KW`
 - `OUTBOUND_AVG_BW`
 - `OUTBOUND_PEAK_BW`
 - `OUTBOUND_PEAK_KW`
- **MODEL:** ethernet hardware to emulate. You can get the list of available models with this command:

```
$ kvm -net nic,model=? -nographic /dev/null
```

- **FILTER** to define a network filtering rule for the interface. Libvirt includes some predefined rules (e.g. `clean-traffic`) that can be used. [Check the Libvirt documentation](#) for more information, you can also list the rules in your system with:

```
$ virsh -c qemu:///system nwfilter-list
```

- **VIRTIO_QUEUES** to define how many queues will be used for the communication between CPUs and Network drivers. This attribute only is available with `MODEL = 'virtio'`.

Graphics

If properly configured, libvirt and KVM can work with **SPICE** ([check this for more information](#)). To select it, just add to the `GRAPHICS` attribute:

- `TYPE = SPICE`

Enabling spice will also make the driver inject specific configuration for these machines. The configuration can be changed in the driver configuration file, variable `SPICE_OPTIONS`.

Virtio

Virtio is the framework for IO virtualization in KVM. You will need a linux kernel with the virtio drivers for the guest, check [the KVM documentation for more info](#).

If you want to use the virtio drivers add the following attributes to your devices:

- DISK, add the attribute `DEV_PREFIX="vd"` or `DEV_PREFIX="sd"`
- NIC, add the attribute `MODE="virtio"`

For disks you can also use SCSI bus (`sd`) and it will use virtio-scsi controller. This controller also offers high speed as it is not emulating real hardware but also adds support to trim commands to free disk space when the disk has the attribute `DISCARD="unmap"`. If needed, you can change the number of vCPU queues this way:

```
FEATURES = [
  VIRTIO_SCSI_QUEUES = 4
]
```

Additional Attributes

The **raw** attribute offers the end user the possibility of passing by attributes not known by OpenNebula to KVM. Basically, everything placed here will be written literally into the KVM deployment file (**use libvirt xml format and semantics**).

```
RAW = [ type = "kvm",
  data = "<devices><serial type=\"pty\"><source path=\"/dev/pts/5\"/><target_
↪port=\"0\"/></serial><console type=\"pty\" tty=\"/dev/pts/5\"><source path=\"/dev/
↪pts/5\"/><target port=\"0\"/></console></devices>" ]
```

Libvirt metadata

The following OpenNebula information is added to the metadata section of the Libvirt domain, the specific attributes are listed below:

- `system_datastore`
- `name`
- `uname`
- `uid`
- `gname`
- `gid`
- `opennebula_version`
- `stime`
- `deployment_time`

They correspond to their values OpenNebula equivalents for the XML representation of the VM. `opennebula_version` and `deployment_time` are the OpenNebula version used during the deployment and deployment time at epoch format, respectively.

Also the VM name is included at Libvirt XML `title` field, so if the `--title` option is used for listing the Libvirt domains the VM name will be shown with the domain name.

Disk/Nic Hotplugging

KVM supports hotplugging to the `virtio` and the `SCSI` buses. For disks, the bus the disk will be attached to is inferred from the `DEV_PREFIX` attribute of the disk template.

- `vd: virtio` (recommended).
- `sd: SCSI` (default).

If `TARGET` is passed instead of `DEV_PREFIX` the same rules apply (what happens behind the scenes is that OpenNebula generates a `TARGET` based on the `DEV_PREFIX` if no `TARGET` is provided).

The defaults for the newly attached disks and NICs are in `/var/lib/one/remotes/etc/vmm/kvm/kvmrc`. The relevant parameters are prefixed with `DEFAULT_ATTACH_` and explained in the *Files and Parameters* below.

For Disks and NICs, if the guest OS is a Linux flavor, the guest needs to be explicitly tell to rescan the PCI bus. This can be done issuing the following command as root:

```
# echo 1 > /sys/bus/pci/rescan
```

Enabling QEMU Guest Agent

QEMU Guest Agent allows the communication of some actions with the guest OS. This agent uses a `virtio` serial connection to send and receive commands. One of the interesting actions is that it allows to freeze the filesystem before doing an snapshot. This way the snapshot won't contain half written data. Filesystem freeze will only be used with `CEPH` and `qcow2` storage drivers.

The agent package needed in the Guest OS is available in most distributions. Is called `qemu-guest-agent` in most of them. If you need more information you can follow these links:

- https://access.redhat.com/documentation/en-US/Red_Hat_Enterprise_Linux/7/html/Virtualization_Deployment_and_Administration_Guide/chap-QEMU_Guest_Agent.html
- http://wiki.libvirt.org/page/Qemu_guest_agent
- <http://wiki.qemu.org/Features/QAPI/GuestAgent>

To enable the communication channel with the guest agent this line must be present in `/etc/one/vmm_exec/vmm_exec_kvm.conf`:

```
RAW = "<devices><channel type='unix'><source mode='bind'></source><target type='virtio' name=
↳ 'org.qemu.guest_agent.0'></target></channel></devices>"
```

Importing VMs

VMs running on KVM hypervisors that were not launched through OpenNebula can be imported in OpenNebula. It is important to highlight that, besides the limitations explained in the host guide, the “Poweroff” operation is not available for these imported VMs in KVM.

7.2.5 Tuning & Extending

Multiple Actions per Host

Warning: This feature is experimental. Some modifications to the code must be done before this is a recommended setup.

By default the drivers use a unix socket to communicate with the libvirt daemon. This method can only be safely used by one process at a time. To make sure this happens the drivers are configured to send only one action per host at a time. For example, there will be only one deployment done per host at a given time.

This limitation can be solved configuring libvirt to accept TCP connections and OpenNebula to use this communication method.

Libvirt configuration

Here is described how to configure libvirtd to accept unencrypted and unauthenticated TCP connections in a CentOS 7 machine. For other setup check your distribution and libvirt documentation.

Change the file `/etc/libvirt/libvirtd.conf` in each of the hypervisors and make sure that these parameters are set and have the following values:

```
listen_tls = 0
listen_tcp = 1
tcp_port = "16509"
auth_tcp = "none"
```

You will also need to modify `/etc/sysconfig/libvirtd` and uncomment this line:

```
LIBVIRT_ARGS="--listen"
```

After modifying these files the libvirt daemon must be restarted:

```
$ sudo systemctl restart libvirtd
```

OpenNebula configuration

The VMM driver must be configured so it allows more than one action to be executed per host. This can be done adding the parameter `-p` to the driver executable. This is done in `/etc/one/oned.conf` in the `VM_MAD` configuration section:

```
VM_MAD = [
  name      = "kvm",
  executable = "one_vmm_exec",
  arguments = "-t 15 -r 0 kvm -p",
  default   = "vmm_exec/vmm_exec_kvm.conf",
  type      = "kvm" ]
```

Change the file `/var/lib/one/remotes/etc/vmm/kvm/kvmrc` so set a TCP endpoint for libvirt communication:

```
export LIBVIRT_URI=qemu+tcp://localhost/system
```

The scheduler configuration should also be changed to let it deploy more than one VM per host. The file is located at `/etc/one/sched.conf` and the value to change is `MAX_HOST`. For example, to let the scheduler submit 10 VMs per host use this line:

```
MAX_HOST = 10
```

After this update the remote files in the nodes and restart opennebula:

```
$ onehost sync --force
$ sudo systemctl restart opennebula
```

Files and Parameters

The driver consists of the following files:

- `/usr/lib/one/mads/one_vmm_exec` : generic VMM driver.
- `/var/lib/one/remotes/vmm/kvm` : commands executed to perform actions.

And the following driver configuration files:

- `/etc/one/vmm_exec/vmm_exec_kvm.conf` : This file is home for default values for domain definitions (in other words, OpenNebula templates).

It is generally a good idea to place defaults for the KVM-specific attributes, that is, attributes mandatory in the KVM driver that are not mandatory for other hypervisors. Non mandatory attributes for KVM but specific to them are also recommended to have a default.

- `/var/lib/one/remotes/etc/vmm/kvm/kvmrc` : This file holds instructions to be executed before the actual driver load to perform specific tasks or to pass environmental variables to the driver. The syntax used for the former is plain shell script that will be evaluated before the driver execution. For the latter, the syntax is the familiar:

```
ENVIRONMENT_VARIABLE=VALUE
```

The parameters that can be changed here are as follows:

Parameter	Description
LIBVIRT_URI	Connection string to libvirtd
QEMU_PROTOCOL	Protocol used for live migrations
SHUTDOWN_TIMEOUT	Seconds to wait after shutdown until timeout
FORCE_DESTROY	Force VM cancellation after shutdown timeout
CANCEL_NO ACPI	Force VM's without ACPI enabled to be destroyed on shutdown
MIGRATE_OPTIONS	Set options for the virsh migrate command
DEFAULT_ATTACH_CACHE	This parameter will set the default cache type for new attached disks. It will be used in case the attached disk does not have an specific cache method set (can be set using templates when attaching a disk).
DEFAULT_ATTACH_DISCARD	Default discard option for newly attached disks, if the attribute is missing in the template.
DEFAULT_ATTACH_IO	Default I/O policy for newly attached disks, if the attribute is missing in the template.
DEFAULT_ATTACH_TOTAL	Default total bytes/s I/O throttling for newly attached disks, if the attribute is missing in the template.
DEFAULT_ATTACH_TOTAL_MAX	Default Maximum total bytes/s I/O throttling for newly attached disks, if the attribute is missing in the template.
DEFAULT_ATTACH_TOTAL_LENGTH	Default Maximum length total bytes/s I/O throttling for newly attached disks, if the attribute is missing in the template.
DEFAULT_ATTACH_READ	Default read bytes/s I/O throttling for newly attached disks, if the attribute is missing in the template.
DEFAULT_ATTACH_READ_MAX	Default Maximum read bytes/s I/O throttling for newly attached disks, if the attribute is missing in the template.
DEFAULT_ATTACH_READ_LENGTH	Default Maximum length read bytes/s I/O throttling for newly attached disks, if the attribute is missing in the template.
DEFAULT_ATTACH_WRITE	Default write bytes/s I/O throttling for newly attached disks, if the attribute is missing in the template.
DEFAULT_ATTACH_WRITE_MAX	Default Maximum write bytes/s I/O throttling for newly attached disks, if the attribute is missing in the template.
DEFAULT_ATTACH_WRITE_LENGTH	Default Maximum length write bytes/s I/O throttling for newly attached disks, if the attribute is missing in the template.
DEFAULT_ATTACH_TOTAL_IOPS	Default total IOPS throttling for newly attached disks, if the attribute is missing in the template.
DEFAULT_ATTACH_TOTAL_MAX_IOPS	Default Maximum total IOPS throttling for newly attached disks, if the attribute is missing in the template.
DEFAULT_ATTACH_TOTAL_LENGTH_IOPS	Default Maximum length total IOPS throttling for newly attached disks, if the attribute is missing in the template.
DEFAULT_ATTACH_READ_IOPS	Default read IOPS throttling for newly attached disks, if the attribute is missing in the template.
DEFAULT_ATTACH_READ_MAX_IOPS	Default Maximum read IOPS throttling for newly attached disks, if the attribute is missing in the template.
DEFAULT_ATTACH_READ_LENGTH_IOPS	Default Maximum length read IOPS throttling for newly attached disks, if the attribute is missing in the template.
DEFAULT_ATTACH_WRITE_IOPS	Default write IOPS throttling for newly attached disks, if the attribute is missing in the template.
DEFAULT_ATTACH_WRITE_MAX_IOPS	Default Maximum write IOPS throttling for newly attached disks, if the attribute is missing in the template.
DEFAULT_ATTACH_WRITE_LENGTH_IOPS	Default Maximum length write IOPS throttling for newly attached disks, if the attribute is missing in the template.
DEFAULT_ATTACH_NIC_MODEL	Default NIC model for newly attached NICs, if the attribute is missing in the template.
DEFAULT_ATTACH_NIC_FILTER	Default NIC libvirt filter for newly attached NICs, if the attribute is missing in the template.

See the Virtual Machine drivers reference for more information.

7.2.6 Troubleshooting

image magic is incorrect

When trying to restore the VM from a suspended state this error is returned:

```
libvirtd1021: operation failed: image magic is incorrect
```

It can be fixed by applying:

```
options kvm_intel nested=0
options kvm_intel emulate_invalid_guest_state=0
options kvm ignore_msrs=1
```

7.3 LXD Driver

LXD is a daemon which provides a REST API to drive LXC containers. Containers are lightweight OS-level Virtualization instances, they behave like Virtual Machines but don't suffer from hardware emulation processing penalties by sharing the kernel with the host.

7.3.1 Requirements

- The host needs to be an Ubuntu system > 1604.
- No hardware support required
- The guest OS will share the Linux kernel with the virtualization node, so you won't be able to launch any non-Linux OS.

Bear in mind that although you can spawn containers with any linux distribution, the kernel will be the one in the host, so you can end up having an ArchLinux container with an Ubuntu kernel.

The LXD drivers support using LXD through snap packages, if there is a snap installed, it will detect it and use that installation path.

7.3.2 Considerations & Limitations

There are a number of regular features that are not implemented yet:

- snapshots
- live migration
- save/restore
- live disk resize
- LVM datastore
- PCI Passthrough
- volatile filesystems
- **offline disk resize:**

- not supported on multiple partition images
- only supported **xfs** and **ext4** filesystems
- **datablocks**: Datablocks created on OpenNebula will need to be formatted before being attached to a container
- **multiple partition images**: One of the partitions must have a valid */etc/fstab* to mount the partitions

7.3.3 Configuration

There are some interaction options between LXD and OpenNebula configured in `/var/tmp/one/etc/vmm/lxd/lxdrc`

```
#####
# VNC Options
#####
#
# Options to customize the VNC access to the container:
# - :command: to be executed in the VNC terminal.
# - :width: of the terminal
# - :height: of the terminal
# - :timeout: seconds to close the terminal if no input has been received
:vnc:
:command: /bin/login
:width: 800
:height: 600
:timeout: 300

#####
# OpenNebula Configuration Options
#####
#
# Default path for the datastores. This only need to be change if the
# corresponding value in oned.conf has been modified.
:datastore_location: /var/lib/one/datastores
```

Important: The **command** parameter under **vnc** dictates which command will appear in noVNC when entering a container. Having `/bin/bash` will skip the login

In case of a more complex cgroup configuration the containers cgroup could be placed in separate slice instead of default root cgroup. You can configure it via an environmental variable

```
export LXC_CGROUP_PREFIX=system.slice
```

LXD daemon

Every existing container should have defined the following limits: `limits.cpu` `limits.vcpu` and `limits.memory`. The `opennebula-node-lxd` package sets the default profile with these limits to 100%, 1 and 512MB.

Drivers

The LXD driver is enabled by default in OpenNebula:

```

#-----
# LXD Virtualization Driver Manager Configuration
# -r number of retries when monitoring a host
# -t number of threads, i.e. number of hosts monitored at the same time
# -l <actions[=command_name]> actions executed locally, command can be
#     overridden for each action.
#     Valid actions: deploy, shutdown, cancel, save, restore, migrate, poll
#     An example: "-l migrate=migrate_local,save"
# -p more than one action per host in parallel, needs support from hypervisor
# -s <shell> to execute remote commands, bash by default
# -w Timeout in seconds to execute external commands (default unlimited)
#-----
VM_MAD = [
    NAME           = "lxd",
    SUNSTONE_NAME  = "LXD",
    EXECUTABLE     = "one_vmm_exec",
    ARGUMENTS      = "-t 15 -r 0 lxd",
    # DEFAULT      = "vmm_exec/vmm_exec_lxd.conf",
    TYPE           = "xml",
    KEEP_SNAPSHOTS = "no",
    IMPORTED_VMS_ACTIONS = "terminate, terminate-hard, reboot, reboot-hard, poweroff, ↵
↵poweroff-hard, suspend, resume, stop, delete, nic-attach,   nic-detach"
]

```

The configuration parameters: `-r`, `-t`, `-l`, `-p` and `-s` are already preconfigured with sane defaults. If you change them you will need to restart OpenNebula.

Read the Virtual Machine Drivers Reference for more information about these parameters, and how to customize and extend the drivers.

7.3.4 Usage

LXD Specific Attributes

The following are template attributes specific to LXD, please refer to the template reference documentation for a complete list of the attributes supported to define a VM.

Security

Containers can be either [privileged](#) or [unprivileged](#) and can also allow nested containers. In order to define this setting in the OpenNebula template you should add:

```

LXD_SECURITY_PRIVILEGED=true
LXD_SECURITY_NESTING=true

```

By default OpenNebula will create unprivileged images

Profiles

The LXD daemon may hold several defined profiles. Every container inherits properties by default from the default profile. However you can set a custom profile to inherit from, in the VM template.

```
LXD_PROFILE=<profile_name>
```

Bear in mind that the template will override any matching key with the profile. If the profile is not found on the node, the default profile will be applied and an error will appear on the VM log.

A probe will run in each node reporting to the frontend which profiles exist on the node in order for them to be easily applied without having to manually look for them.

Disks

Attached disks are handled by `type: disk` devices in the container, this works different from KVM in such a way that the disk is mounted on the LXD host and then the mountpoint is passed-through the container in an user defined mountpoint .

The disk_attaching process, on a high level descriptions follows:

- There is an image file whose contents should be visible inside a container directory
- In order to tell LXD to handle a disk, this file should be mounted on a host directory, `$DATASTORE_LOCATION/$system_datastore_id/$vm_id/mapper/disk.$disk_id`
- The disk can be of different types, currently, the supported ones are **raw** and **qcow2** image files, and ceph **rbd**.
- In order to be mounted, first, each image needs to be mapped to a host device
- Depending on the image type, a different utility will be used, `losetup` for **raw** images, `qemu-nbd` for **qcow2** images and `rbd-nbd` for ceph **rbd**.
- If the image has multiple partitions, each partition will be mounted until an `/etc/fstab` file is found and each partition with a valid filesystem will be mounted accordingly.

Additional Attributes

The **raw** attribute offers the end user the possibility of passing by attributes not known by OpenNebula to LXD. Basically, everything placed here will be written literally into the LXD deployment file.

```
RAW = [ type = "lxd",
        "boot.autostart": "true", "limits.processes": "10000"]
```

Importing VMs

LXD can deploy containers without any resource limitation, however, OpenNebula cannot create a VM without a stated capacity, thus the wild containers should have these keys defined. Once imported, the containers will benefit from:

- start
- stop *hard also*
- restart *hard also*
- attach/detach_nic
- vnc connection

Containers won't get any benefit from storage related actions since they don't have a valid image in the datastore. If you delete the imported container it will become wild again.

7.3.5 Tuning & Extending

Multi-hypervisor

Since LXD doesn't require virtualization extensions, it can peacefully coexist alongside KVM or other HVM hypervisor in the same virtualization node.

Images

The LXD drivers can create containers from images in the same format as KVM, ex. a qcow2 image.

Create your own image

Basically you create a file, map it into a block device, format the device and create a partition, dump data into it and voilà, you have an image.

We will create a container using the LXD CLI and dump it into a block device in order to use it later in OpenNebula datastores. It could be a good time to *contextualize* `<kvm_contextualization>` the container, the procedure is the same as KVM.

```
# truncate -s 2G container.img
# block=$(losetup --find --show container.img)
# mount $block /mnt
# lxc init my-container ubuntu:18.04
# cp -rpa /var/lib/lxd/containers/my-container/rootfs/* /mnt
# umount $block
# losetup -d $block
```

Now the image is ready to be used, you can also use `qemu-img` to convert the image format. Note that you can use any linux standard filesystem / partition layout as a base image for the container. This enables you to easily import images from raw lxc, root partitions from KVM images or proxmox templates.

Use a linuxcontainers.org Marketplace

Every regular LXD setup comes by default with a public image server read access in order to pull container images from.

```
# lxc remote list
+-----+-----+-----+-----+-----+-----+-----+-----+
↪---+-----+-----+
|      NAME      |          URL          |   PROTOCOL   | AUTH_
↪TYPE | PUBLIC | STATIC |
+-----+-----+-----+-----+-----+-----+-----+
↪---+-----+-----+
| images         | https://images.linuxcontainers.org | simplestreams |
↪   | YES   | NO   |
+-----+-----+-----+-----+-----+-----+-----+
↪---+-----+-----+
| local (default) | unix://              | lxd           | tls
↪   | NO   | YES  |
+-----+-----+-----+-----+-----+-----+-----+
↪---+-----+-----+
| ubuntu        | https://cloud-images.ubuntu.com/releases | simplestreams |
↪   | YES  | YES  |
```

(continues on next page)

(continued from previous page)

```

+-----+-----+-----+-----+-----+-----+-----+-----+-----+
↪---+-----+-----+
| ubuntu-daily      | https://cloud-images.ubuntu.com/daily      | simplestreams |
↪   | YES          | YES          |
+-----+-----+-----+-----+-----+-----+-----+-----+-----+
↪---+-----+-----+

```

OpenNebula can leverage the existing **images** server by using it as a backend for a Marketplace..

Use a KVM disk image

The LXD driver can create a container from an image with a partition table, as long as this image has valid fstab file. LXD containers security is based on this uuid mapping, when you start a container its uuids are mapped according to the LXD config. However, sometimes the container rootfs cannot be mapped, this issue happens with the marketplace images, and in order to use the you need to set the `LXD_SECURITY_PRIVILEGED` to true in the container VM template.

You can get this type of images directly from the OpenNebula Marketplace.

Custom storage backends

If you want to customize the supported images ex. *vmdk* files, the LXD driver has some modules called mappers which allow the driver to interact with several image formats like *raw*, *qcow2* and *rbd* devices.

The mapper basically is a ruby class with two methods defined, a `do_map` method, which loads a disk file into a system block device, and an `do_unmap` method, which reverts this ex.

```

disk.qcow2      -> map -> /dev/nbd0
disk.raw        -> map -> /dev/loop0
one/one-7-54-0  -> map -> /dev/nbd0

```

However things can get tricky when dealing with images with a partition table, you can check the code of the mapper devices [here](#).

7.4 Monitoring

This section provides an overview of the OpenNebula monitoring subsystem. The monitoring subsystem gathers information relative to the Hosts and the Virtual Machines, such as the Host status, basic performance indicators, as well as Virtual Machine status and capacity consumption. This information is collected by executing a set of static probes provided by OpenNebula. The output of these probes is sent to OpenNebula using a push mechanism.

7.4.1 Overview

Each host periodically sends monitoring data via UDP to the Frontend which collects it and processes it in a dedicated module. This distributed monitoring system resembles the architecture of dedicated monitoring systems, using a lightweight communication protocol, and a push model.

OpenNebula starts a `collectd` daemon running in the Front-end that listens for UDP connections on port 4124. In the first monitoring cycle the OpenNebula connects to the host using `ssh` and starts a daemon that will execute the probe scripts and sends the collected data to the `collectd` daemon in the Frontend every specific amount of seconds

(configurable with the `-i` option of the `collectd IM_MAD`). This way the monitoring subsystem doesn't need to make new ssh connections to receive data.

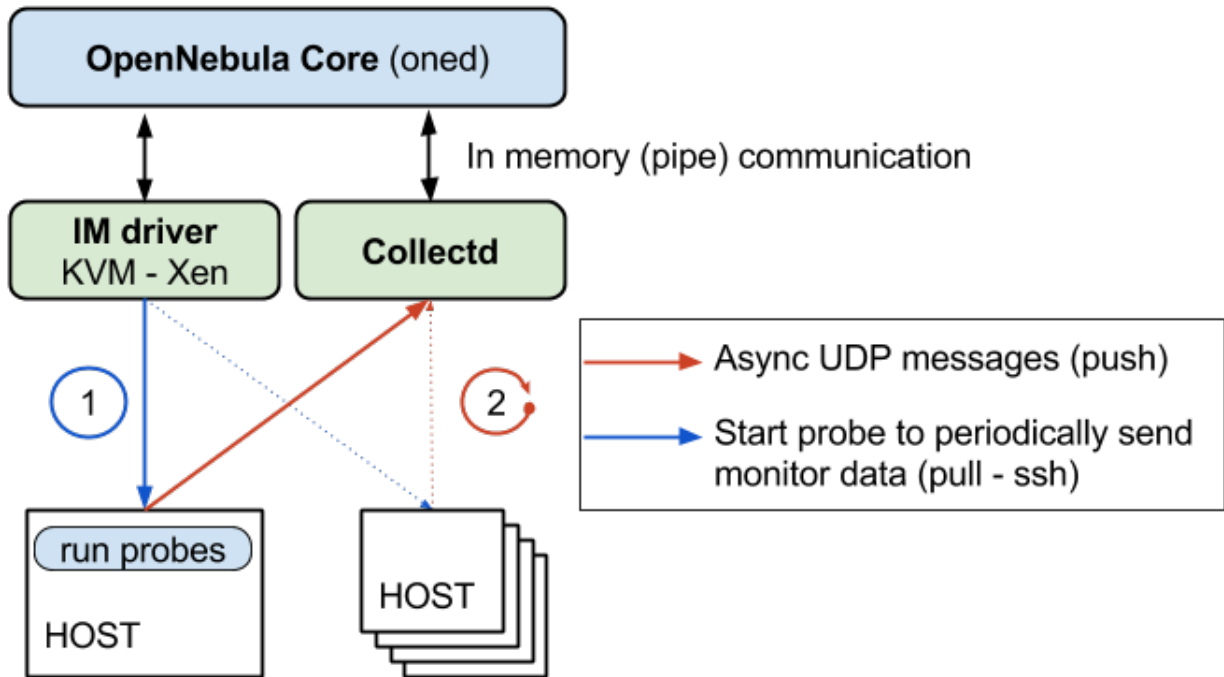

If the agent stops in a specific Host, OpenNebula will detect that no monitoring data is received from that hosts and will restart the probe with SSH.

Apart from the periodical monitoring some specific drivers (SSH and LVM transfer managers) will trigger sending the data instantly when an action is finished. This is done by sending the HUP signal to the `collectd` client on the host. You can trigger the information update manually with the `onehost forceupdate` command.

7.4.2 Requirements

- The firewall of the Frontend (if enabled) must allow UDP packages incoming from the hosts on port 4124.

7.4.3 OpenNebula Configuration

Enabling the Drivers

To enable this monitoring system `/etc/one/oned.conf` must be configured with the following snippets:

`collectd` must be enabled both for KVM:

Note: every setting is also aplicable to LXD

```
#-----
# Information Collector for KVM IM's.
#-----
# This driver CANNOT BE ASSIGNED TO A HOST, and needs to be used with KVM
# -h prints this help.
```

(continues on next page)

(continued from previous page)

```

# -a Address to bind the collectd socket (defaults 0.0.0.0)
# -p UDP port to listen for monitor information (default 4124)
# -f Interval in seconds to flush collected information (default 5)
# -t Number of threads for the server (default 50)
# -i Time in seconds of the monitorization push cycle. This parameter must
#     be smaller than MONITORING_INTERVAL_HOST, otherwise push monitorization will
#     not be effective.
#-----
IM_MAD = [
    NAME           = "collectd",
    EXECUTABLE     = "collectd",
    ARGUMENTS     = "-p 4124 -f 5 -t 50 -i 20" ]
#-----

```

Valid arguments for this driver are:

- **-a:** Address to bind the collectd socket (defaults 0.0.0.0)
- **-p:** port number
- **-f:** Interval in seconds to flush collected information to OpenNebula (default 5)
- **-t:** Number of threads for the collectd server (default 50)
- **-i:** Time in seconds of the monitorization push cycle. This parameter must be smaller than MONITORING_INTERVAL_HOST (see below), otherwise push monitorization will not be effective.

KVM:

```

#-----
# KVM UDP-push Information Driver Manager Configuration
# -r number of retries when monitoring a host
# -t number of threads, i.e. number of hosts monitored at the same time
#-----
IM_MAD = [
    NAME           = "kvm",
    SUNSTONE_NAME = "KVM",
    EXECUTABLE     = "one_im_ssh",
    ARGUMENTS     = "-r 3 -t 15 kvm" ]
#-----

```

The arguments passed to this driver are:

- **-r:** number of retries when monitoring a host
- **-t:** number of threads, i.e. number of hosts monitored at the same time

Monitoring Configuration Parameters

OpenNebula allows to customize the general behavior of the whole monitoring subsystem:

Parameter	Description
MONITORING_INTERVAL_HOST	Time in seconds between host monitorization. It must have a value greater than the manager timer
MONITORING_INTERVAL_VM	Time in seconds between VM monitorization. It must have a value greater than the manager timer
MONITORING_INTERVAL_DATASTORE	Time in seconds between Datastore monitorization. It must have a value greater than the manager timer
MONITORING_INTERVAL_MARKET	Time in seconds between marketplace monitorization. It must have a value greater than the manager timer
HOST_PER_INTERVAL	Number of hosts monitored in each interval.

7.4.4 Troubleshooting

Healthy Monitoring System

Every (approximately) `monitoring_push_cycle` of seconds OpenNebula is receiving the monitoring data of every Virtual Machine and of a host like such:

```
Tue May 24 16:21:47 2016 [Z0][InM][D]: Host thost087 (0) successfully monitored.
Tue May 24 16:21:47 2016 [Z0][VMM][D]: VM 0 successfully monitored: STATE=a CPU=0.0
↔MEMORY=113404 NETRX=648 NETTX=398
Tue May 24 16:22:07 2016 [Z0][InM][D]: Host thost087 (0) successfully monitored.
Tue May 24 16:22:07 2016 [Z0][VMM][D]: VM 0 successfully monitored: STATE=a CPU=0.0
↔MEMORY=113516 NETRX=648 NETTX=468
Tue May 24 16:22:11 2016 [Z0][VMM][D]: VM 0 successfully monitored: DISK_SIZE=[ID=0,
↔SIZE=27] DISK_SIZE=[ID=1,SIZE=1]
Tue May 24 16:22:27 2016 [Z0][InM][D]: Host thost087 (0) successfully monitored.
Tue May 24 16:22:27 2016 [Z0][VMM][D]: VM 0 successfully monitored: STATE=a CPU=0.0
↔MEMORY=113544 NETRX=648 NETTX=468
```

However, if in `oned.log` a host is being monitored **actively** periodically (every `MONITORING_INTERVAL_HOST` seconds) then the monitorization is **not** working correctly:

```
Tue May 24 16:24:23 2016 [Z0][InM][D]: Monitoring host thost087 (0)
Tue May 24 16:25:23 2016 [Z0][InM][D]: Monitoring host thost087 (0)
Tue May 24 16:26:23 2016 [Z0][InM][D]: Monitoring host thost087 (0)
```

If this is the case it's probably because OpenNebula is receiving probes faster than it can process. See the Tuning section to fix this.

Monitoring Probes

For the troubleshooting of errors produced during the execution of the monitoring probes, please refer to the *troubleshooting* section.

7.4.5 Tuning & Extending

Adjust Monitoring Interval Times

In order to tune your OpenNebula installation with appropriate values of the monitoring parameters you need to adjust the `-i` option of the `collectd IM_MAD` (the monitoring push cycle).

If the system is not working healthily it will be due to the database throughput since OpenNebula will write the monitoring information to a database, an amount of ~4KB per VM. If the number of virtual machines is too large and the monitoring push cycle too low, OpenNebula will not be able to write that amount of data to the database.

Driver Files

The probes are specialized programs that obtain the monitor metrics. Probes are defined for each hypervisor, and are located at `/var/lib/one/remotes/im/kvm-probes.d` for KVM.

You can easily write your own probes or modify existing ones, please see the Information Manager Drivers guide. Remember to synchronize the monitor probes in the hosts using `onehost sync` as described in the Managing Hosts guide.

7.5 PCI Passthrough

It is possible to discover PCI devices in the Hosts and assign them to Virtual Machines for the KVM hypervisor.

The setup and environment information is taken from [here](#). You can safely ignore all the VGA related sections, for PCI devices that are not graphic cards, or if you don't want to output video signal from them.

Warning: The overall setup state was extracted from a preconfigured Fedora 22 machine. **Configuration for your distro may be different.**

7.5.1 Requirements

- The host that is going to be used for virtualization needs to support **I/O MMU**. For Intel processors this is called VT-d and for AMD processors is called AMD-Vi. The instructions are made for Intel branded processors but the process should be very similar for AMD.
- kernel \geq 3.12

7.5.2 Machine Configuration (Hypervisor)

Kernel Configuration

The kernel must be configured to support I/O MMU and to blacklist any driver that could be accessing the PCI's that we want to use in our VMs. The parameter to enable I/O MMU is:

```
intel_iommu=on
```

We also need to tell the kernel to load the `vfio-pci` driver and blacklist the drivers for the selected cards. For example, for nvidia GPUs we can use these parameters:

```
rd.driver.pre=vfio-pci rd.driver.blacklist=nouveau
```

Loading vfio Driver in initrd

The modules for vfio must be added to initrd. The list of modules are `vfio vfio_iommu_type1 vfio_pci vfio_virqfd`. For example, if your system uses `dracut` add the file `/etc/dracut.conf.d/local.conf` with this line:

```
add_drivers+="vfio vfio_iommu_type1 vfio_pci vfio_virqfd"
```

and regenerate `initrd`:

```
# dracut --force
```

Driver Blacklisting

The same blacklisting done in the kernel parameters must be done in the system configuration. `/etc/modprobe.d/blacklist.conf` for `nvidia` GPUs:

```
blacklist nouveau
blacklist lbm-nouveau
options nouveau modeset=0
alias nouveau off
alias lbm-nouveau off
```

Alongside this configuration `vfio` driver should be loaded passing the id of the PCI cards we want to attach to VMs. For example, for `nvidia` Grid K2 GPU we pass the id `10de:11bf`. File `/etc/modprobe.d/local.conf`:

```
options vfio-pci ids=10de:11bf
```

vfio Device Binding

I/O MMU separates PCI cards into groups to isolate memory operation between devices and VMs. To add the cards to `vfio` and assign a group to them we can use the scripts shared in the [aforementioned web page](#).

This script binds a card to `vfio`. It goes into `/usr/local/bin/vfio-bind`:

```
#!/bin/sh
modprobe vfio-pci
for dev in "$@"; do
    vendor=$(cat /sys/bus/pci/devices/$dev/vendor)
    device=$(cat /sys/bus/pci/devices/$dev/device)
    if [ -e /sys/bus/pci/devices/$dev/driver ]; then
        echo $dev > /sys/bus/pci/devices/$dev/driver/unbind
    fi
    echo $vendor $device > /sys/bus/pci/drivers/vfio-pci/new_id
done
```

The configuration goes into `/etc/sysconfig/vfio-bind`. The cards are specified with PCI addresses. Addresses can be retrieved with `lspci` command. Make sure to prepend the domain that is usually `0000`. For example:

```
DEVICES="0000:04:00.0 0000:05:00.0 0000:84:00.0 0000:85:00.0"
```

Here is a `systemd` script that executes the script. It can be written to `/etc/systemd/system/vfio-bind.service` and enabled:

```
[Unit]
Description=Binds devices to vfio-pci
After=syslog.target

[Service]
EnvironmentFile=-/etc/sysconfig/vfio-bind
Type=oneshot
RemainAfterExit=yes
ExecStart=-/usr/local/bin/vfio-bind $DEVICES

[Install]
WantedBy=multi-user.target
```

qemu Configuration

Now we need to give qemu access to the vfio devices for the groups assigned to the PCI cards. We can get a list of PCI cards and its I/O MMU group using this command:

```
# find /sys/kernel/iommu_groups/ -type l
```

In our example our cards have the groups 45, 46, 58 and 59 so we add this configuration to `/etc/libvirt/qemu.conf`:

```
cgroup_device_acl = [
    "/dev/null", "/dev/full", "/dev/zero",
    "/dev/random", "/dev/urandom",
    "/dev/ptmx", "/dev/kvm", "/dev/kqemu",
    "/dev/rtc", "/dev/hpet", "/dev/vfio/vfio",
    "/dev/vfio/45", "/dev/vfio/46", "/dev/vfio/58",
    "/dev/vfio/59"
]
```

7.5.3 Driver Configuration

The only configuration needed is the filter for the monitoring probe that gets the list of PCI cards. By default, the probe doesn't list any cards from a host. To narrow the list, configuration can be changed in `/var/lib/one/remotes/etc/im/kvm-probes.d/pci.conf`. Following configuration attributes are available:

Parameter	Description
<code>filter</code>	List Filters by PCI vendor:device:class patterns (same as as for <code>lspci</code>)
<code>short_address</code>	List Filters by short PCI address bus:device.function
<code>device_name</code>	List Filters by device names with case-insensitive regular expression patterns

All filters are applied on the final PCI cards list.

Example:

```
# This option specifies the main filters for PCI card monitoring. The format
# is the same as used by lspci to filter on PCI card by vendor:device(:class)
# identification. Several filters can be added as a list, or separated
# by commas. The NULL filter will retrieve all PCI cards.
#
# From lspci help:
```

(continues on next page)

(continued from previous page)

```

# -d [<vendor>]:[<device>][:<class>]
#     Show only devices with specified vendor, device and class ID.
#     The ID's are given in hexadecimal and may be omitted or given
#     as "*", both meaning "any value"#
#
# For example:
# :filter:
# - '10de:*'      # all NVIDIA VGA cards
# - '10de:11bf'  # only GK104GL [GRID K2]
# - '*:10d3'     # only 82574L Gigabit Network cards
# - '8086::0c03' # only Intel USB controllers
#
# or
#
# :filter: '*:*'  # all devices
#
# or
#
# :filter: '0:0'  # no devices
#
:filter: '*:*'

# The PCI cards list restricted by the :filter option above can be even more
# filtered by the list of exact PCI addresses (bus:device.func).
#
# For example:
# :short_address:
# - '07:00.0'
# - '06:00.0'
#
:short_address:
- '00:1f.3'

# The PCI cards list restricted by the :filter option above can be even more
# filtered by matching the device name against the list of regular expression
# case-insensitive patterns.
#
# For example:
# :device_name:
# - 'Virtual Function'
# - 'Gigabit Network'
# - 'USB.*Host Controller'
# - '^MegaRAID'
#
:device_name:
- 'Ethernet'
- 'Audio Controller'

```

7.5.4 Usage

The basic workflow is to inspect the host information, either in the CLI or in Sunstone, to find out the available PCI devices, and to add the desired device to the template. PCI devices can be added by specifying VENDOR, DEVICE and CLASS, or simply CLASS. Note that OpenNebula will only deploy the VM in a host with the available PCI device. If no hosts match, an error message will appear in the Scheduler log.

CLI

A new table in `onehost show` command gives us the list of PCI devices per host. For example:

```

PCI DEVICES

  VM ADDR      TYPE                NAME
    00:00.0  8086:0a04:0600  Haswell-ULT DRAM Controller
    00:02.0  8086:0a16:0300  Haswell-ULT Integrated Graphics Controller
123 00:03.0  8086:0a0c:0403  Haswell-ULT HD Audio Controller
    00:14.0  8086:9c31:0c03  8 Series USB xHCI HC
    00:16.0  8086:9c3a:0780  8 Series HECI #0
    00:1b.0  8086:9c20:0403  8 Series HD Audio Controller
    00:1c.0  8086:9c10:0604  8 Series PCI Express Root Port 1
    00:1c.2  8086:9c14:0604  8 Series PCI Express Root Port 3
    00:1d.0  8086:9c26:0c03  8 Series USB EHCI #1
    00:1f.0  8086:9c43:0601  8 Series LPC Controller
    00:1f.2  8086:9c03:0106  8 Series SATA Controller 1 [AHCI mode]
    00:1f.3  8086:9c22:0c05  8 Series SMBus Controller
    02:00.0  8086:08b1:0280  Wireless 7260

```

- **VM:** The VM ID using that specific device. Empty if no VMs are using that device.
- **ADDR:** PCI Address.
- **TYPE:** Values describing the device. These are `VENDOR:DEVICE:CLASS`. These values are used when selecting a PCI device do to passthrough.
- **NAME:** Name of the PCI device.

To make use of one of the PCI devices in a VM a new option can be added selecting which device to use. For example this will ask for a Haswell-ULT HD Audio Controller:

```

PCI = [
  VENDOR = "8086",
  DEVICE = "0a0c",
  CLASS = "0403"
]

```

The device can be also specified without all the type values. For example, to get any PCI Express Root Ports this can be added to a VM template:

```

PCI = [
  CLASS = "0604"
]

```

More than one PCI options can be added to attach more than one PCI device to the VM.

Sunstone

In Sunstone the information is displayed in the **PCI** tab:

VM	PCI Address	Type	Name
	00:00.0	8086:1604:0600	Broadwell-U Host Bridge -OPI
	00:02.0	8086:1616:0300	Broadwell-U Integrated Graphics
	00:03.0	8086:160c:0403	Broadwell-U Audio Controller
	00:04.0	8086:1603:1180	Broadwell-U Camarillo Device
	00:14.0	8086:9cb1:0c03	Wildcat Point-LP USB xHCI Controller
	00:16.0	8086:9cba:0780	Wildcat Point-LP MEI Controller #1
	00:1b.0	8086:9ca0:0403	Wildcat Point-LP High Definition Audio Controller
	00:1c.0	8086:9c90:0604	Wildcat Point-LP PCI Express Root Port #1
	00:1c.3	8086:9c96:0604	Wildcat Point-LP PCI Express Root Port #4
	00:1d.0	8086:9ca6:0c03	Wildcat Point-LP USB EHCI Controller

To add a PCI device to a template, select the **Other** tab:

General
Storage
Network
OS Booting
Input/Output
Context
Scheduling
Hybrid
Other

RAW data

TYPE	DATA ?

PCI Devices

Vendor	Device	Class

+ Add PCI device

7.5.5 Usage as Network Interfaces

It is possible to use a PCI device as a NIC interface directly in OpenNebula. In order to do so you will need to follow the configuration steps mentioned in this guide, namely changing the device driver.

When defining a Network that will be used for PCI passthrough nics, please use either the `dummy` network driver or the `802.1Q` if you are using VLAN. In any case, type any random value into the `BRIDGE` field, and it will be ignored. For `802.1Q` you can also leave `PHYDEV` blank.

The context packages support the configuration of the following attributes:

- **MAC:** It will change the mac address of the corresponding network interface to the MAC assigned by OpenNebula.
- **IP:** It will assign an IPv4 address to the interface, assuming a /24 netmask.
- **IPV6:** It will assign an IPv6 address to the interface, assuming a /128 netmask.
- **VLAN_ID:** If present, it will create a tagged interface and assign the IPs to the tagged interface.

CLI

When a PCI in a template contains the attribute `TYPE="NIC"`, it will be treated as a NIC and OpenNebula will assign a MAC address, a `VLAN_ID`, an IP, etc, to the PCI device.

This is an example of the PCI section of an interface that will be treated as a NIC:

```
PCI=[
  NETWORK="passthrough",
  NETWORK_UNAME="oneadmin",
  TYPE="NIC",
  CLASS="0200",
  DEVICE="10d3",
  VENDOR="8086" ]
```

Note that the order of appearance of the PCI elements and NIC elements in the template is relevant. They will be mapped to nics in the order they appear, regardless if they're NICs or PCIs.

Sunstone

In the Network tab, under advanced options check the **PCI Passthrough** option and fill in the PCI address. Use the rest of the dialog as usual by selecting a network from the table.

Hardware

PCI passthrough

Device name	Vendor	Device	Class
82574L Gigabit Network Connection ▼	8086	10d3	0200

OPEN CLOUD STORAGE SETUP

8.1 Overview

8.1.1 Datastore Types

OpenNebula storage is structured around the Datastore concept. A Datastore is any storage medium to store disk images. OpenNebula features three different datastore types:

- The **Images Datastore**, stores the images repository.
- The **System Datastore** holds disk for running virtual machines. Disk are moved, or cloned to/from the Images datastore when the VMs are deployed or terminated; or when disks are attached or snapshotted.
- The **Files & Kernels Datastore** to store plain files and not disk images. The plain files can be used as kernels, ram-disks or context files. *See details here.*

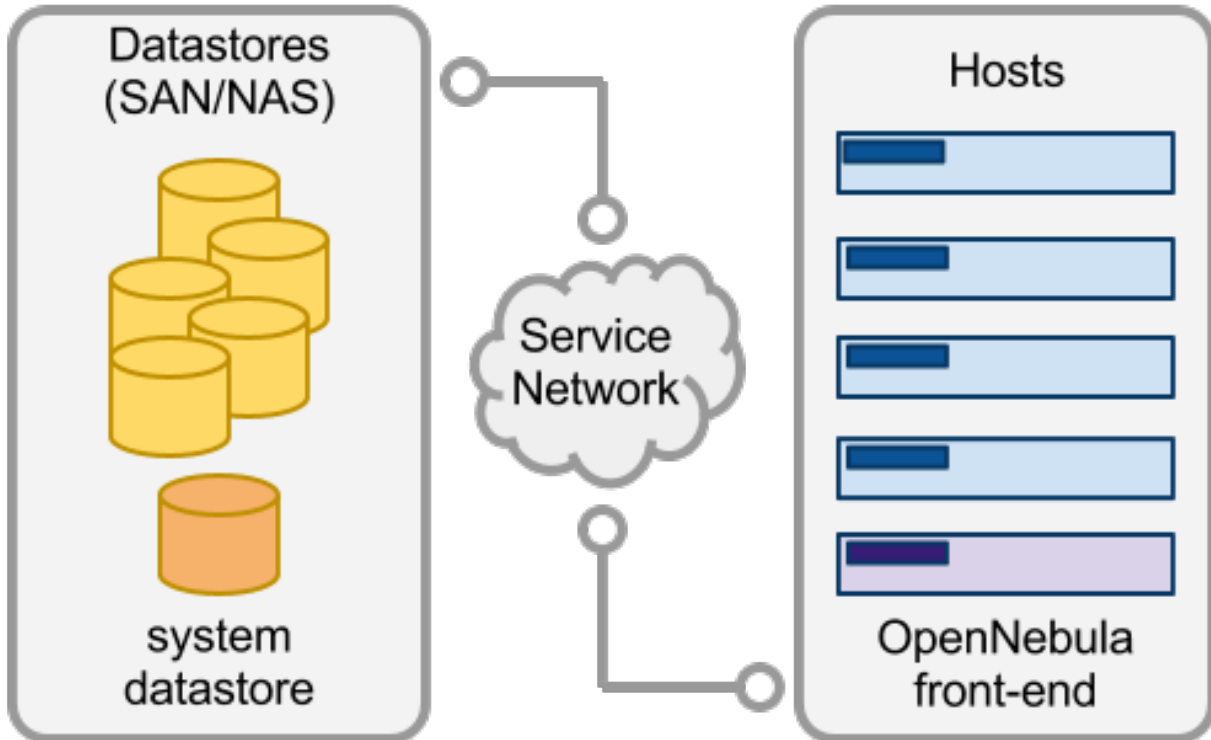

Image Datastores

There are different Image Datastores depending on how the images are stored on the underlying storage technology:

- *Filesystem*, to store images in a file form.
- *LVM*, to store images in LVM logical volumes.
- *Ceph*, to store images using Ceph block devices.
- *Raw Device Mapping*, to direct attach to the virtual machine existing block devices in the nodes.
- *iSCSI - Libvirt Datastore*, to access iSCSI devices through the built-in qemu support.

Disk images are transferred between the Image and System datastores by the transfer manager (TM) drivers. These drivers are specialized pieces of software that perform low-level storage operations. The following table summarizes the available transfer modes for each datastore:

Datastore	Image to System Datastore disk transfers methods
Filesystem	<ul style="list-style-type: none"> • shared, images are exported in a shared filesystem • ssh, images are copied using the ssh protocol • qcow2, like <i>shared</i> but specialized for the qcow2 format
Ceph	<ul style="list-style-type: none"> • ceph, all images are exported in Ceph pools • shared, volatile & context disks exported in a shared FS.
LVM	<ul style="list-style-type: none"> • fs_lvm, images exported in a shared FS but dumped to a LV
Raw Devices	<ul style="list-style-type: none"> • dev, images are existing block devices in the nodes
iSCSI libvirt	<ul style="list-style-type: none"> • iscsi, images are iSCSI targets

8.1.2 How Should I Read This Chapter

Before reading this chapter make sure you have read the *Open Cloud Host* chapter. After that, proceed to the specific section for the Datastores you may be interested in.

After reading this chapter you should read the *Open Cloud Networking* chapter.

8.1.3 Hypervisor Compatibility

This chapter applies to KVM and LXD.

Note: LXD Drivers only support Filesystem and Ceph

Follow the *vCenter Storage* section for a similar guide for vCenter.

8.2 Filesystem Datastore

The Filesystem Datastore lets you store VM images in a file form. The use of file-based disk images presents several benefits over device backed disks (e.g. easily backup images, or use of shared FS) although it may not perform as well in some cases.

Usually it is a good idea to have multiple filesystem datastores to:

- Balancing I/O operations between storage servers
- Use different datastores for different cluster hosts
- Apply different transfer modes to different images
- Different SLA policies (e.g. backup) can be applied to different VM types or users
- Easily add new storage to the cloud

The Filesystem datastore can be used with three different transfer modes, described below:

- **shared**, images are exported in a shared filesystem
- **ssh**, images are copied using the ssh protocol
- **qcow2**, like *shared* but specialized for the qcow2 format

8.2.1 Datastore Layout

Images are saved into the corresponding datastore directory (`/var/lib/one/datastores/<DATASTORE ID>`). Also, for each running virtual machine there is a directory (named after the VM ID) in the corresponding System Datastore. These directories contain the VM disks and additional files, e.g. checkpoint or snapshots.

For example, a system with an Image Datastore (1) with three images and 3 Virtual Machines (VM 0 and 2 running, and VM 7 stopped) running from System Datastore 0 would present the following layout:

```

/var/lib/one/datastores
|-- 0/
|   |-- 0/
|   |   |-- disk.0
|   |   |-- disk.1
|   |   |-- 2/
|   |       |-- disk.0
|   |       |-- 7/
|   |           |-- checkpoint
|   |           |-- disk.0
|-- 1
|   |-- 05a38ae85311b9dbb4eb15a2010f11ce
|   |-- 2bbec245b382fd833be35b0b0683ed09
|   |-- d0e0df1fb8cfa88311ea54dfbcfc4b0c

```

Note: The canonical path for `/var/lib/one/datastores` can be changed in `oned.conf` with the `DATASTORE_LOCATION` configuration attribute

Shared & Qcow2 Transfer Modes

The shared transfer driver assumes that the datastore is mounted in all the hosts of the cluster. Typically this is achieved through a distributed FS like NFS, GlusterFS or Lustre.

When a VM is created, its disks (the `disk.i` files) are copied or linked in the corresponding directory of the system datastore. These file operations are always performed remotely on the target host.

This transfer mode usually reduces VM deployment times and **enables live-migration**, but it can also become a bottleneck in your infrastructure and degrade your Virtual Machines performance if the virtualized services perform disk-intensive workloads. Usually this limitation may be overcome by:

- Using different file-system servers for the images datastores, so the actual I/O bandwidth is balanced
- Using an ssh System Datastore instead, the images are copied locally to each host
- Tuning or improving the file-system servers

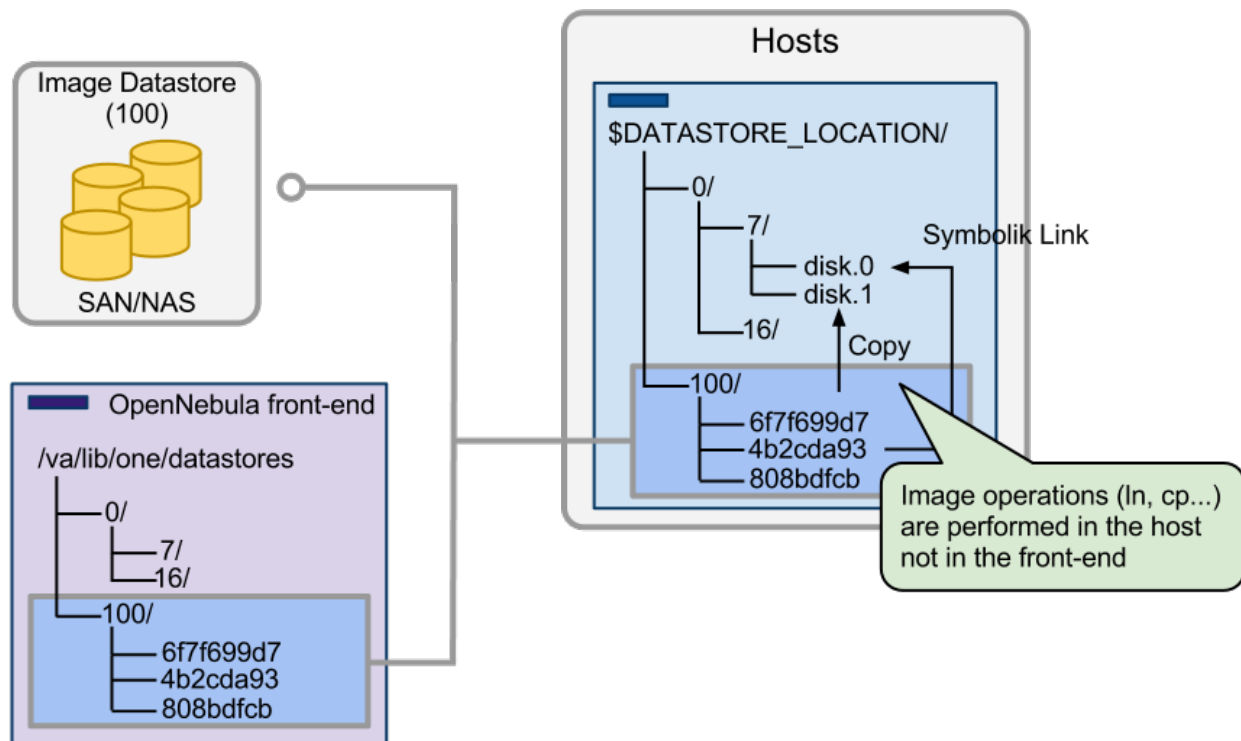

SSH Transfer Mode

In this case the System Datastore is distributed among the hosts. The ssh transfer driver uses the hosts' local storage to place the images of running Virtual Machines. All the operations are then performed locally but images have to be copied always to the hosts, which in turn can be a very resource demanding operation. Also this driver prevents the use of live-migrations between hosts.

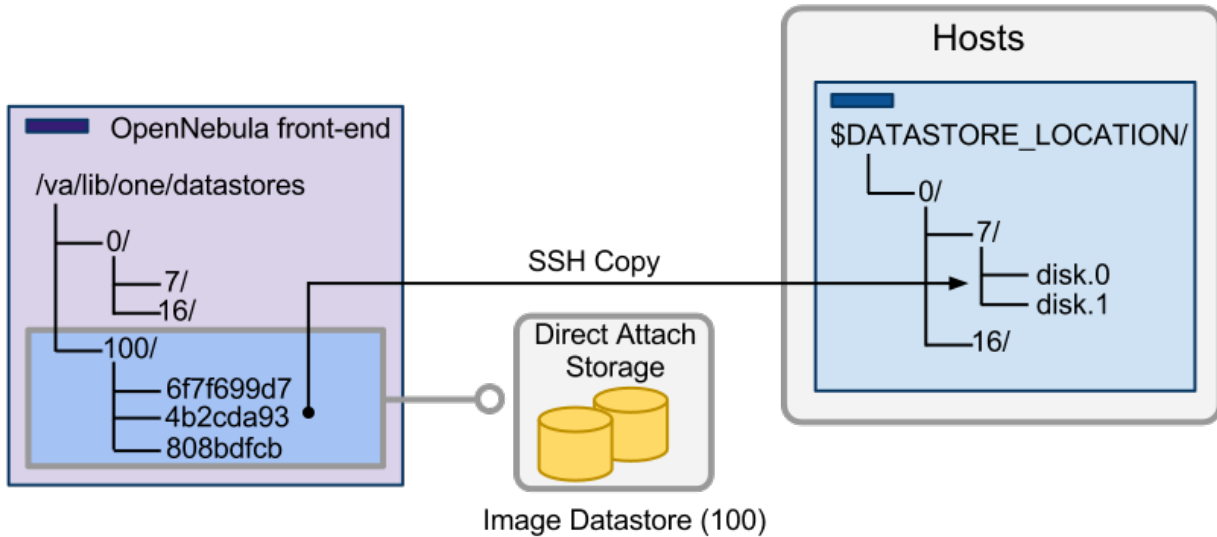

8.2.2 Frontend Setup

The Frontend needs to prepare the storage area for:

- The Image Datastores, to store the images.
- The System Datastores, will hold temporary disks and files for VMs stopped and undeployed.

Shared & Qcow2 Transfer Modes

Simply mount the **Image** Datastore directory in the front-end in `/var/lib/one/datastores/<datastore_id>`. Note that if all the datastores are of the same type you can mount the whole `/var/lib/one/datastores` directory.

Warning: The frontend only needs to mount the Image Datastores and **not** the System Datastores.

Note: NFS volumes mount tips. The following options are recommended to mount a NFS shares: `soft, intr, rsize=32768, wsize=32768`. With the documented configuration of libvirt/kvm the image files are accessed as `oneadmin` user. In case the files must be read by `root` the option `no_root_squash` must be added.

SSH Transfer Mode

Simply make sure that there is enough space under `/var/lib/one/datastores` to store Images and the disks of the stopped and undeployed virtual machines. Note that `/var/lib/one/datastores` **can be mounted from any NAS/SAN server in your network**.

8.2.3 Node Setup

Shared & Qcow2 Transfer Modes

The configuration is the same as for the Frontend above, simply mount in each node the datastore directories in `/var/lib/one/datastores/<datastore_id>`.

SSH Transfer Mode

Just make sure that there is enough space under `/var/lib/one/datastores` to store the disks of running VMs on that host.

Warning: Make sure all the hosts, including the frontend, can ssh to any other host (including themselves). Otherwise migrations will not work.

8.2.4 OpenNebula Configuration

Once the Filesystem storage is setup, the OpenNebula configuration comprises two steps:

- Create a System Datastore
- Create an Image Datastore

Create a System Datastore

To create a new System Datastore you need to specify its type as system datastore and transfer mode:

Attribute	Description
NAME	The name of the datastore
TYPE	SYSTEM_DS
TM_MAD	shared for shared transfer mode qcow2 for qcow2 transfer mode ssh for ssh transfer mode

This can be done either in Sunstone or through the CLI, for example to create a System Datastore using the shared mode simply:

```
$ cat systemds.txt
NAME      = nfs_system
TM_MAD    = shared
TYPE      = SYSTEM_DS

$ onedatastore create systemds.txt
ID: 101
```

Note: When different system datastore are available the `TM_MAD_SYSTEM` attribute will be set after picking the datastore.

Create an Image Datastore

In the same way, to create an Image Datastore you need to set:

Attribute	Description
NAME	The name of the datastore
DS_MAD	fs
TM_MAD	shared for shared transfer mode qcow2 for qcow2 transfer mode ssh for ssh transfer mode

For example, the following illustrates the creation of a filesystem datastore using the shared transfer drivers.

```
$ cat ds.conf
NAME    = nfs_images
DS_MAD  = fs
TM_MAD  = shared

$ onedatastore create ds.conf
ID: 100
```

Also note that there are additional attributes that can be set, check the datastore template attributes.

Warning: Be sure to use the same `TM_MAD` for both the System and Image datastore. When combining different transfer modes, check the section below.

Additional Configuration

- `CONVERT`: `yes` (default) or `no`. If `DRIVER` is set on the image datastore, this option controls whether the images in different formats are internally converted into the `DRIVER` format on import.
- `QCOW2_OPTIONS`: Custom options for the `qemu-img clone` action. The `qcow2` drivers are a specialization of the shared drivers to work with the `qcow2` format for disk images. Images are created and through the `qemu-img` command using the original image as backing file. Custom options can be sent to `qemu-img clone` action through the variable `QCOW2_OPTIONS` in `/var/lib/one/remotes/tm/tmrc`.

Combining the shared & SSH Transfer Modes

When using the shared mode, you can improve VM performance by placing the disks in the host local storage area. In this way, you will have a repository of images (distributed across the hosts using a shared FS) but the VMs running from the local disks. This effectively combines shared and SSH modes above.

Important: You can still use the pure shared mode in this case. In this way the same image can be deployed in a shared mode or a ssh mode (per VM).

Warning: This setup will increase performance at the cost of increasing deployment times.

To configure this scenario, simply configure a shared Image and System datastores as described above (TM_MAD=shared). Then add a SSH system datastore (TM_MAD=ssh). Any image registered in the Image datastore can now be deployed using the shared or SSH system datastores.

Warning: If you added the shared datastores to cluster, you need to add the new SSH system datastore to the very same clusters.

To select the (alternate) deployment mode, add the following attribute to the Virtual Machine template:

- TM_MAD_SYSTEM="ssh"

8.3 Ceph Datastore

The Ceph datastore driver provides OpenNebula users with the possibility of using Ceph block devices as their Virtual Images.

Warning: This driver requires that the OpenNebula nodes using the Ceph driver must be Ceph clients of a running Ceph cluster. More information in [Ceph documentation](#).

Note: LXD drivers require the rbd-nbd package installed in order to handle rbd images

8.3.1 Datastore Layout

Images are stored in a Ceph pool, named after its OpenNebula id `one-<IMAGE ID>`. Virtual machine disks are stored by default in the same pool (Ceph Mode). You can also choose to export the Image rbd to the hypervisor local storage using the SSH Mode.

Important: Only is necessary to register each image once, then it can be deployed using any mode, ceph or ssh.

Ceph Mode (Default)

In this mode, virtual machines will use the same Image rbd volumes for its disks (persistent images), or a new snapshots of the image created in the form `one-<IMAGE ID>-<VM ID>-<DISK ID>` (non-persistent images).

For example, consider a system using an Image and System Datastore backed by a Ceph pool named `one`. The pool with one Image (ID 0) and two Virtual Machines 14 and 15 using this Image as virtual disk 0 would be similar to:

```
$ rbd ls -l -p one --id libvirt
NAME          SIZE PARENT          FMT PROT LOCK
one-0         10240M                2
one-0@snap    10240M                2 yes
one-0-14-0    10240M one/one-0@snap      2
one-0-15-0    10240M one/one-0@snap      2
```

Note: In this case context disk and auxiliary files (deployment description and checkpoints) are stored locally in the nodes.

SSH Mode

In this mode, the associated rbd file for each disk is exported to a file and stored in the local file system of the hypervisor.

For example, in the previous example if the VM 14 is set to be deployed in a SSH system datastore (e.g. 100), the layout of the datastore in the hypervisor would be similar to:

```
$ ls -l /var/lib/one/datastores/100/14
total 609228
-rw-rw-r-- 1 oneadmin oneadmin      1020 Dec 20 14:41 deployment.0
-rw-r--r-- 1 oneadmin oneadmin 10737418240 Dec 20 15:19 disk.0
-rw-rw-r-- 1 oneadmin oneadmin   372736 Dec 20 14:41 disk.1
```

Note: In this case disk.0 is generated with a command similar to `rbd export one/one-0@snap disk.0`

8.3.2 Ceph Cluster Setup

This guide assumes that you already have a functional Ceph cluster in place. Additionally you need to:

- Create a pool for the OpenNebula datastores. Write down the name of the pool to include it in the datastore definitions.

```
$ ceph osd pool create one 128

$ ceph osd lspools
0 data,1 metadata,2 rbd,6 one,
```

- Define a Ceph user to access the datastore pool; this user will also be used by libvirt to access the disk images. For example, create a user libvirt:

On the **Ceph Jewel** (v10.2.x) and before:

```
$ ceph auth get-or-create client.libvirt \
    mon 'allow r' osd 'allow class-read object_prefix rbd_children, allow rwx_
↪pool=one'
```

On the **Ceph Luminous** (v12.2.x) and later:

```
$ ceph auth get-or-create client.libvirt \
    mon 'profile rbd' osd 'profile rbd pool=one'
```

Warning: Ceph Luminous release comes with simplified RBD capabilities (more information about user management and authorization capabilities is in the [Ceph documentation](#)). When **upgrading existing Ceph deployment to the Luminous and later**, please ensure the selected user has proper new capabilities. For example, for above user libvirt by running:

```
$ ceph auth caps client.libvirt \
    mon 'profile rbd' osd 'profile rbd pool=one'
```

- Get a copy of the key of this user to distribute it later to the OpenNebula nodes.

```
$ ceph auth get-key client.libvirt | tee client.libvirt.key
$ ceph auth get client.libvirt -o ceph.client.libvirt.keyring
```

- Although RBD format 1 is supported it is strongly recommended to use Format 2. Check that `ceph.conf` includes:

```
[global]
rbd_default_format = 2
```

- Pick a set of client nodes of the cluster to act as storage bridges. These nodes will be used to import images into the Ceph Cluster from OpenNebula. These nodes must have `qemu-img` command installed.

Note: For production environments it is recommended to **not co-allocate** ceph services (monitor, osds) with OpenNebula nodes or front-end

8.3.3 Frontend and Node Setup

In order to use the Ceph cluster the nodes need to be configured as follows:

- The ceph client tools must be available in the machine
- The `mon` daemon must be defined in the `ceph.conf` for all the nodes, so `hostname` and `port` doesn't need to be specified explicitly in any Ceph command.
- Copy the Ceph user keyring (`ceph.client.libvirt.keyring`) to the nodes under `/etc/ceph`, and the user key (`client.libvirt.key`) to the `oneadmin` home.

```
$ scp ceph.client.libvirt.keyring root@node:/etc/ceph
$ scp client.libvirt.key oneadmin@node:
```

8.3.4 Node Setup

Nodes need extra steps to setup credentials in libvirt:

- Generate a secret for the Ceph user and copy it to the nodes under `oneadmin` home. Write down the UUID for later use.

```
$ UUID=`uuidgen`; echo $UUID
c7bdeabf-5f2a-4094-9413-58c6a9590980

$ cat > secret.xml <<EOF
<secret ephemeral='no' private='no'>
  <uuid>$UUID</uuid>
  <usage type='ceph'>
    <name>client.libvirt secret</name>
```

(continues on next page)

(continued from previous page)

```

    </usage>
</secret>
EOF

$ scp secret.xml oneadmin@node:

```

- Define the a libvirt secret and remove key files in the nodes:

```

$ virsh -c qemu:///system secret-define secret.xml

$ virsh -c qemu:///system secret-set-value --secret $UUID --base64 $(cat client.
→libvirt.key)

$ rm client.libvirt.key

```

- The oneadmin account needs to access the Ceph Cluster using the libvirt Ceph user defined above. This requires access to the ceph user keyring. Test that Ceph client is properly configured in the node.

```

$ ssh oneadmin@node

$ rbd ls -p one --id libvirt

```

You can read more information about this in the Ceph guide [Using libvirt with Ceph](#).

- Ancillary virtual machine files like context disks, deployment and checkpoint files are created at the nodes under `/var/lib/one/datastores/`, make sure that enough storage for these files is provisioned in the nodes.
- If you are going to use the SSH mode, you have to take into account the space needed for the system datastore `/var/lib/one/datastores/<ds_id>` where `ds_id` is the ID of the System Datastore.

8.3.5 OpenNebula Configuration

To use your Ceph cluster with the OpenNebula, you need to define a System and Image datastores. Each Image/System Datastore pair will share same following Ceph configuration attributes:

Attribute	Description	Mandatory
NAME	The name of the datastore	YES
POOL_NAME	The Ceph pool name	YES
CEPH_USER	The Ceph user name, used by libvirt and rbd commands.	YES
CEPH_KEY	Key file for user, if not set default locations are used	NO
CEPH_CONF	Non default ceph configuration file if needed.	NO
RBD_FORMAT	By default RBD Format 2 will be used.	NO
BRIDGE_LIST	List of storage bridges to access the Ceph cluster	YES
CEPH_HOST	Space-separated list of Ceph monitors. Example: <code>host1 host2:port2 host3 host4:port4</code> .	YES
CEPH_SECRET	The UUID of the libvirt secret.	YES
EC_POOL_NAME	Name of Ceph erasure coded pool	NO

Note: You may add another Image and System Datastores pointing to other pools with different allocation/replication policies in Ceph.

Note: Ceph Luminous release allows use of erasure coding for RBD images. In general, erasure coded images take up less space, but have worse I/O performance. Erasure coding can be enabled on Image and/or System Datas-tores by configuring `EC_POOL_NAME` with the name of the erasure coded data pool. Regular replicated Ceph pool `POOL_NAME` is still required for image metadata. More information in [Ceph documentation](#).

Create a System Datastore

System Datastore also requires these attributes:

At-tribute	Description	Manda-tory
TYPE	SYSTEM_DS	YES
TM_MAD	ceph (to use the full ceph mode, see above) ssh (to use local host storage, ssh mode above)	YES

Create a System Datastore in Sunstone or through the CLI, for example:

```
$ cat systemds.txt
NAME      = ceph_system
TM_MAD    = ceph
TYPE      = SYSTEM_DS

POOL_NAME = one
CEPH_HOST = "host1 host2:port2"
CEPH_USER = libvirt
CEPH_SECRET = "6f88b54b-5dae-41fe-a43e-b2763f601cfc"

BRIDGE_LIST = cephfrontend

$ onedatastore create systemds.txt
ID: 101
```

Note: When different system datastore are available the `TM_MAD_SYSTEM` attribute will be set after picking the datastore.

Create an Image Datastore

Apart from the previous attributes, that need to be the same as the associated System Datastore, the following can be set for an Image Datastore:

Attribute	Description	Mandatory
NAME	The name of the datastore	YES
DS_MAD	ceph	YES
TM_MAD	ceph	YES
DISK_TYPE	RBD	YES
STAGING_DIR	Default path for image operations in the bridges	NO

An example of datastore:

```

> cat ds.conf
NAME = "cephds"
DS_MAD = ceph
TM_MAD = ceph

DISK_TYPE = RBD

POOL_NAME = one
CEPH_HOST = "host1 host2:port2"
CEPH_USER = libvirt
CEPH_SECRET = "6f88b54b-5dae-41fe-a43e-b2763f601cfc"

BRIDGE_LIST = cephfrontend

> onedatastore create ds.conf
ID: 101

```

Warning: If you are going to use the `TM_MAD_SYSTEM` attribute with SSH mode, you need to have an *SSH type system Datastore* configured.

Note: See quotas for more information about quotas over Ceph backend storage.

Additional Configuration

Default values for the Ceph drivers can be set in `/var/lib/one/remotes/etc/datastore/ceph/ceph.conf`:

- `POOL_NAME`: Default volume group
- `STAGING_DIR`: Default path for image operations in the storage bridges
- `RBD_FORMAT`: Default format for RBD volumes.

Using different modes

When creating a VM Template you can choose to deploy the disks using the default Ceph mode or the SSH on. Note that the same mode will be used for all disks of the VM. To set the deployment mode add the following attribute to the VM template:

- `TM_MAD_SYSTEM="ssh"`

When using Sunstone, the deployment mode needs to be set in Storage tab.

8.4 LVM Datastore

The LVM datastore driver provides OpenNebula with the possibility of using LVM volumes instead of plain files to hold the Virtual Images. This reduces the overhead of having a file-system in place and thus it may increase I/O performance.

8.4.1 Datastore Layout

Images are stored as regular files (under the usual path: `/var/lib/one/datastores/<id>`) in the Image Datastore, but they will be dumped into a Logical Volumes (LV) upon virtual machine creation. The virtual machines will run from Logical Volumes in the node.

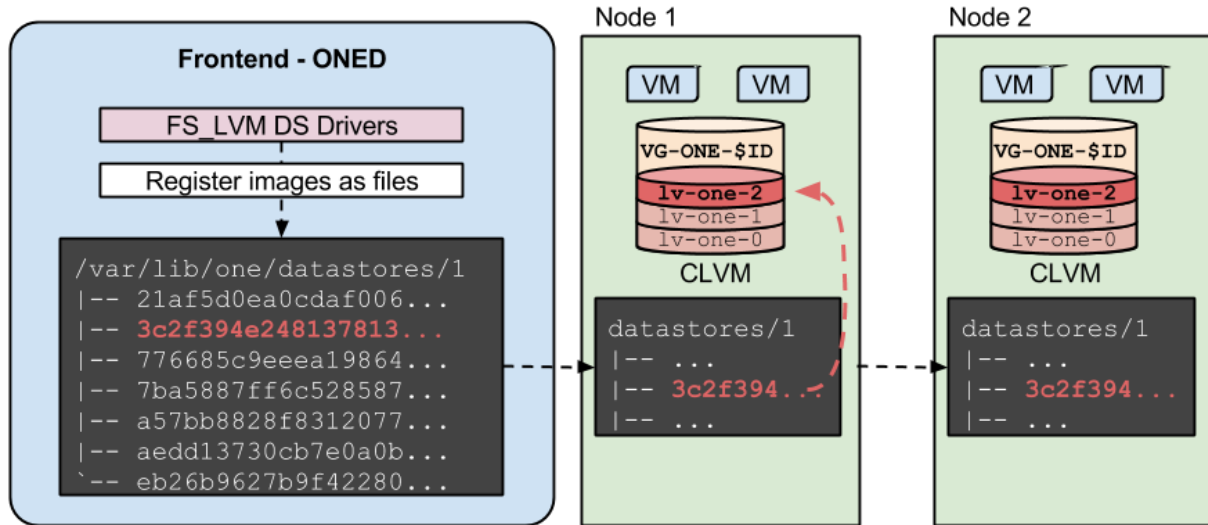

This is the recommended driver to be used when a high-end SAN is available. The same LUN can be exported to all the hosts, Virtual Machines will be able to run directly from the SAN.

Note: The LVM datastore does **not** need CLVM configured in your cluster. The drivers refresh LVM meta-data each time an image is needed in another host.

For example, consider a system with two Virtual Machines (9 and 10) using a disk, running in a LVM Datastore, with ID 0. The nodes have configured a shared LUN and created a volume group named `vg-one-0`, the layout of the datastore would be:

```
# lvs
LV          VG          Attr          LSize Pool Origin Data%  Meta%  Move
lv-one-10-0 vg-one-0    -wi----- 2.20g
lv-one-9-0  vg-one-0    -wi----- 2.20g
```

Warning: Images are stored in a shared storage in file form (e.g. NFS, GlusterFS...) the datastore directories and mount points needs to be configured as a regular shared image datastore, *please refer to [File System Datastore guide](#)*. It is a good idea to first deploy a shared File System datastore and once it is working replace the associated System datastore with the LVM one maintaining the shared mount point as described below.

8.4.2 Frontend Setup

- The frontend needs to have access to the images datastore, mounting the associated directory.

8.4.3 Node Setup

Nodes needs to meet the following requirements:

- LVM2 must be available in the Hosts.
- `lvmetad` must be disabled. Set this parameter in `/etc/lvm/lvm.conf`: `use_lvmetad = 0`, and disable the `lvm2-lvmetad.service` if running.
- `oneadmin` needs to belong to the `disk` group.
- All the nodes needs to have access to the same LUNs.
- A LVM VG needs to be created in the shared LUNs for each datastore following name: `vg-one-<system_ds_id>`. This just need to be done in one node.
- Virtual Machine disks are symbolic links to the block devices. However, additional VM files like checkpoints or deployment files are stored under `/var/lib/one/datastores/<id>`. Be sure that enough local space is present.
- All the nodes needs to have access to the images and system datastores, mounting the associated directories.

Note: In case of the virtualization host reboot, the volumes need to be activated to be available for the hypervisor again. If the *node package* is installed, the activation is done automatically. Otherwise, each volume device of the virtual machines running on the host before the reboot needs to be activated manually by running `lvchange -ay $DEVICE` (or, activation script `/var/tmp/one/tm/fs_lvm/activate` from the remote scripts may be executed on the host to do the job).

8.4.4 OpenNebula Configuration

Once the storage is setup, the OpenNebula configuration comprises two steps:

- Create a System Datastore
- Create an Image Datastore

Create a System Datastore

LVM System Datastores needs to be created with the following values:

Attribute	Description
NAME	The name of the Datastore
TM_MAD	<code>fs_lvm</code>
TYPE	<code>SYSTEM_DS</code>
BRIDGE_LIST	List of nodes with access to the LV to monitor it

For example:

```
> cat ds.conf
NAME      = lvm_system
TM_MAD    = fs_lvm
TYPE      = SYSTEM_DS
BRIDGE_LIST = node1.kvm.lvm node2.kvm.lvm

> onedatastore create ds.conf
ID: 100
```

Create an Image Datastore

To create an Image Datastore you just need to define the name, and set the following:

Attribute	Description
NAME	The name of the datastore
TYPE	IMAGE_DS
DS_MAD	fs
TM_MAD	fs_lvm
DISK_TYPE	BLOCK

For example, the following examples illustrates the creation of an LVM datastore using a configuration file. In this case we will use the host `host01` as one of our OpenNebula LVM-enabled hosts.

```
> cat ds.conf
NAME = production
DS_MAD = fs
TM_MAD = fs_lvm
DISK_TYPE = "BLOCK"
TYPE = IMAGE_DS
SAFE_DIRS="/var/tmp /tmp"

> onedatastore create ds.conf
ID: 101
```

Driver Configuration

By default the LVM driver will zero any LVM volume so VM data cannot leak to other instances. However, this process takes some time and may delay the deployment of a VM. The behavior of the driver can be configured in the file `/var/lib/one/remotes/etc/fs_lvm/fs_lvm.conf`, in particular:

Attribute	Description
ZERO_LVM_ON_CREATE	Zero LVM volumes when they are created/resized
ZERO_LVM_ON_DELETE	Zero LVM volumes when VM disks are deleted

Example:

```
# Zero LVM volumes on creation or resizing
ZERO_LVM_ON_CREATE=no

# Zero LVM volumes on delete, when the VM disks are disposed
ZERO_LVM_ON_DELETE=yes
```

8.5 Raw Device Mapping (RDM) Datastore

The RDM Datastore is an Image Datastore that enables raw access to node block devices.

Warning: The datastore should only be usable by the administrators. Letting users create images in this datastore will cause security problems. For example, register an image `/dev/sda` and reading the host filesystem.

8.5.1 Datastore Layout

The RDM Datastore is used to register already existent block devices in the nodes. The devices should be already setup and available and, VMs using these devices must be fixed to run in the nodes ready for them. Additional virtual machine files, like deployment files or volatile disks are created as regular files.

8.5.2 Frontend Setup

No additional setup is required.

8.5.3 Node Setup

The devices you want to attach to a VM should be accessible by the hypervisor. As KVM usually runs as oneadmin, make sure this user is in a group with access to the disk (like disk) and has read write permissions for the group.

8.5.4 OpenNebula Configuration

Once the storage is setup, the OpenNebula configuration comprises two steps:

- Create a System Datastore
- Create an Image Datastore

Create a System Datastore

The RDM Datastore can work with the following System Datastores:

- Filesystem, shared transfer mode
- Filesystem, ssh transfer mode

Please refer to the *Filesystem Datastore section* for more details. Note that the System Datastore is only used for volatile disks and context devices.

Create an Image Datastore

To create an Image Datastore you just need to define the name, and set the following:

Attribute	Description
NAME	The name of the datastore
TYPE	IMAGE_DS
DS_MAD	dev
TM_MAD	dev
DISK_TYPE	BLOCK

An example of datastore:

```
> cat rdm.conf
NAME      = rdm_datastore
TYPE      = "IMAGE_DS"
DS_MAD    = "dev"
```

(continues on next page)

(continued from previous page)

```

TM_MAD      = "dev"
DISK_TYPE   = "BLOCK"

> onedatastore create rdm.conf
ID: 101

```

8.5.5 Datastore Usage

New images can be added as any other image specifying the path. If you are using the CLI do not use the shorthand parameters as the CLI check if the file exists and the device most probably won't exist in the frontend. As an example here is an image template to add a node disk /dev/sdb:

```

NAME=scsi_device
PATH=/dev/sdb
PERSISTENT=YES

```

Note: As this datastore does is just a container for existing devices images does not take any size from it. All devices registered will render size of 0 and the overall devices datastore will show up with 1MB of available space

8.6 iSCSI - Libvirt Datastore

This datastore is used to register already existing iSCSI volume available to the hypervisor nodes

Warning: The datastore should only be usable by the administrators. Letting users create images in this datastore can cause security problems.

8.6.1 Frontend Setup

No additional configuration is needed

8.6.2 Node Setup

The nodes need to meet the following requirements: * The devices you want to attach to a VM should be accessible by the hypervisor. * Qemu needs to be compiled with Libiscsi support.

iSCSI CHAP Authentication

In order to use CHAP authentication, you will need to create a libvirt secret in **all** the hypervisors. Follow this [Libvirt Secret XML format](#) guide to register the secret. Take this into consideration:

- incominguser field on the iSCSI authentication file should match the Datastore's ISCSI_USER parameter.
- <target> field in the secret XML document will contain the ISCSI_USAGE parameter.
- Do this in all the hypervisors.

8.6.3 OpenNebula Configuration

Once the storage is setup, the OpenNebula configuration comprises two steps:

- Create a System Datastore
- Create an Image Datastore

Create a System Datastore

The RDM Datastore can work with the following System Datastores:

- Filesystem, shared transfer mode
- Filesystem, ssh transfer mode

Please refer to the *Filesystem Datastore section* for more details. Note that the System Datastore is only used for volatile disks and context devices.

Create an Image Datastore

To create an Image Datastore you just need to define the name, and set the following:

Attribute	Description
NAME	The name of the datastore
TYPE	IMAGE_DS
DS_MAD	iscsi_libvirt
TM_MAD	iscsi_libvirt
DISK_TYPE	ISCSI
ISCSI_HOST	iSCSI Host. Example: host or host:port.

If you need to use CHAP authentication (optional) add the following attributes to the datastore:

Attribute	Description
ISCSI_USAGE	Usage of the secret with the CHAP Auth string.
ISCSI_USER	user the iSCSI CHAP authentication.

An example of datastore:

```
> cat iscsi.ds
NAME = iscsi

DISK_TYPE = "ISCSI"

DS_MAD = "iscsi_libvirt"
TM_MAD = "iscsi_libvirt"

ISCSI_HOST = "the_iscsi_host"
ISCSI_USER = "the_iscsi_user"
ISCSI_USAGE = "the_iscsi_usage"

> onedatastore create iscsi.ds
ID: 101
```

Warning: Images created in this datastore should be persistent. Making the images non persistent allows more than one VM use this device and will probably cause problems and data corruption.

8.6.4 Datastore Usage

New images can be added as any other image specifying the path. If you are using the CLI **do not use the shorthand parameters** as the CLI check if the file exists and the device most probably won't exist in the frontend.

As an example here is an image template to add a node disk `iqn.1992-01.com.example:storage:diskarrays-sn-a8675309`:

```
NAME = iscsi_device
PATH = iqn.1992-01.com.example:storage:diskarrays-sn-a8675309
PERSISTENT = YES
```

Warning: As this datastore does is just a container for existing devices images does not take any size from it. All devices registered will render size of 0 and the overall devices datastore will show up with 1MB of available space

Note: You may override the any of the following: `ISCSI_HOST`, `ISCSI_USER``, `ISCSI_USAGE` and `ISCSI_IQN` parameters in the image template. These overridden parameters will come into effect for new Virtual Machines.

Here is an example of an iSCSI LUN template that uses the iSCSI transfer manager.

```
oneadmin@onedv:~/exampletemplates$ more iscsiimage.tpl
NAME=iscsi_device_with_lun
PATH=iqn.2014.01.192.168.50.61:test:7cd2cc1e/0
ISCSI_HOST=192.168.50.61
PERSISTENT=YES
```

Note the explicit “/0” at the end of the IQN target path. This is the iSCSI LUN ID.

8.7 The Kernels & Files Datastore

The Files Datastore lets you store plain files to be used as VM kernels, ramdisks or context files. The Files Datastore does not expose any special storage mechanism but a simple and secure way to use files within VM templates. There is a Files Datastore (datastore ID: 2) ready to be used in OpenNebula.

8.7.1 Requirements

There are no special requirements or software dependencies to use the Files Datastore. The recommended drivers make use of standard filesystem utils (`cp`, `ln`, `mv`, `tar`, `mkfs...`) that should be installed in your system.

8.7.2 Configuration

Most of the configuration considerations used for disk images datastores do apply to the Files Datastore (e.g. driver setup, cluster assignment, datastore management...).

The specific attributes for this datastore driver are listed in the following table, you will also need to complete with the common datastore attributes:

Attribute	Description
TYPE	Use <code>FILE_DS</code> to setup a Files datastore
DS_MAD	The DS type, use <code>fs</code> to use the file-based drivers
TM_MAD	Transfer drivers for the datastore, use <code>ssh</code> to transfer the files

For example, the following illustrates the creation of File Datastore.

```
> cat kernels_ds.conf
NAME = kernels
DS_MAD = fs
TM_MAD = ssh
TYPE = FILE_DS
SAFE_DIRS = /var/tmp/files

> onedatastore create kernels_ds.conf
ID: 100

> onedatastore list
  ID NAME                CLUSTER  IMAGES  TYPE DS      TM
  -- --                -        -      -   -   -
   0 system              -        0  sys  -     dummy
   1 default             -        0  img  dummy dummy
   2 files               -        0  fil  fs    ssh
 100 kernels            -        0  fil  fs    ssh
```

The DS and TM MAD can be changed later using the `onedatastore update` command. You can check more details of the datastore by issuing the `onedatastore show` command.

8.7.3 Host Configuration

The recommended `ssh` driver for the File Datastore does not need any special configuration for the hosts. Just make sure that there is enough space under `$DATASTORE_LOCATION` to hold the VM files in the front-end and hosts.

For more details *refer to the [Filesystem Datastore guide](#)*, as the same configuration guidelines applies.

OPEN CLOUD NETWORKING SETUP

9.1 Overview

When a new Virtual Machine is launched, OpenNebula will connect its network interfaces (defined by NIC attribute) to hypervisor physical devices as defined in the Virtual Network. This will allow the VM to have access to different networks, public or private.

OpenNebula supports four different networking modes:

- *Bridged*. The Virtual Machine is directly attached to an existing bridge in the hypervisor. This mode can be configured to use security groups and network isolation.
- *VLAN*. Virtual Networks are implemented through 802.1Q VLAN tagging.
- *VXLAN*. Virtual Networks implements VLANs using the VXLAN protocol that relies on a UDP encapsulation and IP multicast.
- *Open vSwitch*. Similar to the VLAN mode but using an openvswitch instead of a Linux bridge.
- *Open vSwitch on VXLAN*. Similar to the VXLAN mode but using an openvswitch instead of a Linux bridge.

When you create a new network you will need to add the attribute `VN_MAD` to the template, specifying which of the above networking modes you want to use.

Note: Security Groups are not supported by the Open vSwitch mode.

Finally, the networking stack of OpenNebula can be integrated with an external IP address manager (IPAM). To do so, you need to develop the needed glue, for more details refer to the IPAM driver guide.

9.1.1 How Should I Read This Chapter

Before reading this chapter make sure you have read the *Open Cloud Storage* chapter.

Start by reading the common *Node Setup* section to learn how to configure your hosts, and then proceed to the specific section for the networking mode that you are interested in.

After reading this chapter you can complete your OpenNebula installation by optionally enabling an *External Authentication* or configuring *Sunstone*. Otherwise you are ready to Operate your Cloud.

9.1.2 Hypervisor Compatibility

This chapter applies to KVM and LXD.

9.2 Node Setup

This guide includes specific node setup steps to enable each network mode. You **only need** to apply the corresponding section to the select mode.

9.2.1 Bridged Networking Mode

Requirements

- The OpenNebula node packages has been installed, see *the KVM node installation section* for more details.
- By default, network isolation is provided through `ebtables`, this package needs to be installed in the nodes.

Configuration

- Create a linux bridge for each network that would be expose to Virtual Machines. Use the same name in all the nodes.
- Add the physical network interface to the bridge.

For example, a node with two networks one for public IP addresses (attached to `eth0`) and another one for private traffic (NIC `eth1`) should have two bridges:

```
$ brctl show
bridge name bridge id          STP enabled interfaces
br0           8000.001e682f02ac no         eth0
br1           8000.001e682f02ad no         eth1
```

Note: It is recommended that this configuration is made persistent. Please refer to the network configuration guide of your system to do so.

9.2.2 VLAN Networking Mode

Requirements

- The OpenNebula node packages has been installed, see *the KVM node installation section* for more details.
- The `8021q` module must be loaded in the kernel.
- A network switch capable of forwarding VLAN tagged traffic. The physical switch ports should be VLAN trunks.

Configuration

No additional configuration is needed.

9.2.3 VXLAN Networking Mode

Requirements

- The OpenNebula node packages has been installed, see *the KVM node installation section* for more details.
- The node must run a Linux kernel (>3.7.0) that natively supports the VXLAN protocol and the associated iproute2 package.
- When all the nodes are connected to the same broadcasting domain be sure that the multicast traffic is not filtered by any iptable rule in the nodes. Note that if the multicast traffic needs to traverse routers a multicast protocol like IGMP needs to be configured in your network.

Configuration

No additional configuration is needed.

9.2.4 Open vSwitch Networking Mode

Requirements

- The OpenNebula node packages has been installed, see *the KVM node installation section* for more details.
- You need to install Open vSwitch on each node. Please refer to the Open vSwitch documentation to do so.

For example, a node that forwards Virtual Networks traffic through the `enp0s8` network interface should create an openvswitch like:

```
# ovs-vsctl show
c61ba96f-fc11-4db9-9636-408e763f529e
    Bridge "ovsbr0"
        Port "ovsbr0"
            Interface "ovsbr0"
                type: internal
        Port "enp0s8"
            Interface "enp0s8"
```

Configuration

- Create a openvswitch for each network that would be expose to Virtual Machines. Use the same name in all the nodes.
- Add the physical network interface to the openvswitch.

Note: It is recommended that this configuration is made persistent. Please refer to the network configuration guide of your system to do so.

9.3 Bridged Networking

This guide describes how to deploy Bridged networks. In this mode, the virtual machine traffic is directly bridged through the Linux bridge in the nodes. Bridged networks can operate in four different modes depending on the

additional traffic filtering made by the OpenNebula:

- **Dummy Bridged**, no filtering, no bridge setup (legacy no-op driver).
- **Bridged**, no filtering is made, managed bridge.
- **Bridged with Security Groups**, iptables rules are installed to implement security groups rules.
- **Bridged with ebttables VLAN**, same as above plus additional ebttables rules to isolate (L2) each Virtual Networks.

9.3.1 Considerations & Limitations

The following needs to be considered regarding traffic isolation:

- In the **Dummy Bridged**, **Bridged** and **Bridged with Security Groups** modes you can add tagged network interfaces to achieve network isolation. This is the **recommended** deployment strategy in production environments in this mode.
- The **Bridged with ebttables VLAN** mode is targeted to small environments without proper hardware support to implement VLANS. Note that it is limited to /24 networks and that IP addresses cannot overlap between Virtual Networks. This mode is only recommended for testing purposes.

9.3.2 OpenNebula Configuration

The following configuration attributes can be adjusted in `/var/lib/one/remotes/etc/vnm/OpenNebulaNetwork.conf`:

Parameter	Description
<code>ipset_maxelem</code>	Maximal number of entries in the IP set (used for the security group rules)
<code>keep_empty_bridge</code>	Set to true to preserve bridges with no virtual interfaces left.
<code>bridge_conf</code>	<i>Hash</i> Options for <code>brctl</code>

9.3.3 Defining a Bridged Network

To create a virtual network include the following information:

Attribute	Value	Mandatory
VN_MAD	<ul style="list-style-type: none"> • <code>dummy</code> for the Dummy Bridged mode • <code>bridge</code> for the Bridged mode • <code>fw</code> for Bridged with Security Groups • <code>ebttables</code> for Bridged with ebttables isolation 	YES
BRIDGE	Name of the linux bridge in the nodes	YES
PHYDEV	Name of the physical network device that will be attached to the bridge (does not apply for dummy driver)	NO

The following example defines Bridged network with the Security Groups mode:

```
NAME      = "bridged_net"
VN_MAD    = "fw"
BRIDGE    = vbr1
...
```

9.3.4 ebttables VLAN Mode: default rules

This section lists the ebttables rules that are created, in case you need to debug your setup

```
# Drop packets that don't match the network's MAC Address
-s ! <mac_address>/ff:ff:ff:ff:ff:0 -o <tap_device> -j DROP
# Prevent MAC spoofing
-s ! <mac_address> -i <tap_device> -j DROP
```

9.4 802.1Q VLAN Networks

This guide describes how to enable Network isolation provided through host-managed VLANs. This driver will create a bridge for each OpenNebula Virtual Network and attach an VLAN tagged network interface to the bridge. This mechanism is compliant with IEEE 802.1Q.

The VLAN id will be the same for every interface in a given network, automatically computed by OpenNebula. It may also be forced by specifying an VLAN_ID parameter in the Virtual Network template.

9.4.1 OpenNebula Configuration

The VLAN_ID is calculated according to this configuration option of `oned.conf`:

```
# VLAN_IDS: VLAN ID pool for the automatic VLAN_ID assigment. This pool
# is for 802.1Q networks (Open vSwitch and 802.1Q drivers). The driver
# will try first to allocate VLAN_IDS[START] + VNET_ID
#   start: First VLAN_ID to use
#   reserved: Comma separated list of VLAN_IDs or ranges. Two numbers
#   separated by a colon indicate a range.

VLAN_IDS = [
    START      = "2",
    RESERVED   = "0, 1, 4095"
]
```

By modifying that parameter you can reserve some VLANs so they aren't assigned to a Virtual Network. You can also define the first VLAN_ID. When a new isolated network is created, OpenNebula will find a free VLAN_ID from the VLAN pool. This pool is global, and it's also shared with the *Open vSwitch* network mode.

The following configuration attributes can be adjusted in `/var/lib/one/remotes/etc/vnm/OpenNebulaNetwork.conf`:

Parameter	Description
<code>validate_vlan_id</code>	Set to true to check that no other vlans are connected to the bridge
<code>keep_empty_bridge</code>	Set to true to preserve bridges with no virtual interfaces left.
<code>bridge_conf</code>	<i>Hash</i> Options for <code>brctl</code>
<code>ip_link_conf</code>	<i>Hash</i> Arguments passed to <code>ip link add</code>

Example:

```
# These options will execute brctl commands with these values. For example,
# this option will execute:
#
#     brctl stp <bridge name> on
#
:bridge_conf:
    :stp: on

# These options will be added to the ip link add command. For example:
#
#     sudo ip link add lxcbr0.260 type vxlan id 260 group 239.0.101.4 \
#         ttl 16 dev lxcbr0 udp6zerocsumrx tos 3
#
:ip_link_conf:
    :udp6zerocsumrx:
    :tos: 3
```

9.4.2 Defining a 802.1Q Network

To create a 802.1Q network include the following information:

Attribute	Value	Mandatory
VN_MAD	802.1Q	YES
PHYDEV	Name of the physical network device that will be attached to the bridge.	YES
BRIDGE	Name of the linux bridge, defaults to onebr<net_id> or onebr.<vlan_id>	NO
VLAN_ID	The VLAN ID, will be generated if not defined and AUTO-MATIC_VLAN_ID is set to YES	YES (unless AUTOMATIC_VLAN_ID)
AUTO-MATIC_VLAN_ID	Mandatory and must be set to YES if VLAN_ID hasn't been defined	YES (unless VLAN_ID)
MTU	The MTU for the tagged interface and bridge	NO

The following example defines a 802.1Q network

```
NAME      = "hmnet"
VN_MAD    = "802.1Q"
PHYDEV    = "eth0"
VLAN_ID   = 50           # optional. If not setting VLAN_ID set AUTOMATIC_VLAN_ID = "YES"
BRIDGE    = "brhm"      # optional
```

In this scenario, the driver will check for the existence of the `brhm` bridge. If it doesn't exist it will be created. `eth0` will be tagged (`eth0.50`) and attached to `brhm` (unless it's already attached).

9.5 VXLAN Networks

This guide describes how to enable Network isolation provided through the VXLAN encapsulation protocol. This driver will create a bridge for each OpenNebula Virtual Network and attach a VXLAN tagged network interface to the bridge.

The VLAN id will be the same for every interface in a given network, calculated automatically by OpenNebula. It may also be forced by specifying an `VLAN_ID` parameter in the Virtual Network template.

Additionally each VLAN has associated a multicast address to encapsulate L2 broadcast and multicast traffic. This address is assigned by default to the 239.0.0.0/8 range as defined by RFC 2365 (Administratively Scoped IP Multicast). In particular the multicast address is obtained by adding the `VLAN_ID` to the 239.0.0.0/8 base address.

9.5.1 Considerations & Limitations

This driver works with the default UDP server port 8472.

VXLAN traffic is forwarded to a physical device, this device can be set (optionally) to be a VLAN tagged interface, but in that case you must make sure that the tagged interface is manually created first in all the hosts.

The physical device that will act as the physical device **must** have an IP.

Concurrent VXLANs host limit

Each VXLAN is associated with one multicast group. There is a limit on how many multicast groups can be a physical host member of at the same time. That also means, how many **different** VXLANs can be used on a physical host concurrently. The default value is 20 and can be changed via `sysctl` through kernel runtime parameter `net.ipv4.igmp_max_memberships`.

For permanent change to e.g. 150, place following settings inside the `/etc/sysctl.conf`:

```
net.ipv4.igmp_max_memberships=150
```

and reload the configuration

```
$ sudo sysctl -p
```

9.5.2 OpenNebula Configuration

It is possible specify the start VLAN ID by configuring `/etc/one/oned.conf`:

```
# VXLAN_IDS: Automatic VXLAN Network ID (VNI) assignment. This is used
# for vxlan networks.
#   start: First VNI to use

VXLAN_IDS = [
    START = "2"
]
```

The following configuration attributes can be adjusted in `/var/lib/one/remotes/etc/vnm/OpenNebulaNetwork.conf`:

Parameter	Description
<code>vxlan_mc</code>	Base multicast address for each VLAN. The multicas sddress is <code>vxlan_mc + vxlan_id</code>
<code>vxlan_ttl</code>	Time To Live (TTL) should be > 1 in routed multicast networks (IGMP)
<code>validate_vlan_id</code>	Set to true to check that no other vlans are connected to the bridge
<code>keep_empty_bridge</code>	Set to true to preserve bridges with no virtual interfaces left.
<code>bridge_conf</code>	<i>Hash</i> Options for <code>brctl</code>
<code>ip_link_conf</code>	<i>Hash</i> Arguments passed to <code>ip link add</code>

Example:

```
# These options will execute brctl commands with these values. For example,
# this option will execute:
#
#     brctl stp <bridge name> on
#
:bridge_conf:
    :stp: on

# These options will be added to the ip link add command. For example:
#
#     sudo ip link add lxcbr0.260 type vxlan id 260 group 239.0.101.4 \
#         ttl 16 dev lxcbr0 udp6zerocsumrx tos 3
#
:ip_link_conf:
    :udp6zerocsumrx:
    :tos: 3
```

9.5.3 Defining a VXLAN Network

To create a VXLAN network include the following information:

Attribute	Value	Mandatory
VN_MAD	vxlan	YES
PHYDEV	Name of the physical network device that will be attached to the bridge.	YES
BRIDGE	Name of the linux bridge, defaults to onebr<net_id> or onebr.<vlan_id>	NO
VLAN_ID	The VLAN ID, will be generated if not defined	NO
MTU	The MTU for the tagged interface and bridge	NO

The following example defines a VXLAN network

```
NAME      = "vxlan_net"
VN_MAD    = "vxlan"
PHYDEV    = "eth0"
VLAN_ID   = 50          # optional
BRIDGE    = "vxlan50" # optional
...
```

In this scenario, the driver will check for the existence of the `vxlan50` bridge. If it doesn't exist it will be created. `eth0` will be tagged (`eth0.50`) and attached to `vxlan50` (unless it's already attached). Note that `eth0` can be a 802.1Q tagged interface if you want to isolate the OpenNebula VXLAN traffic.

9.6 Open vSwitch Networks

This guide describes how to use the [Open vSwitch](#) network drives. They provide network isolation using VLANs by tagging ports and basic network filtering using OpenFlow. Other traffic attributes that may be configured through Open vSwitch are not modified.

The VLAN id will be the same for every interface in a given network, calculated automatically by OpenNebula. It may also be forced by specifying an `VLAN_ID` parameter in the Virtual Network template.

Warning: This driver is not compatible with Security Groups.

9.6.1 OpenNebula Configuration

The `VLAN_ID` is calculated according to this configuration option of `oned.conf`:

```
# VLAN_IDS: VLAN ID pool for the automatic VLAN_ID assignment. This pool
# is for 802.1Q networks (Open vSwitch and 802.1Q drivers). The driver
# will try first to allocate VLAN_IDS[START] + VNET_ID
#   start: First VLAN_ID to use
#   reserved: Comma separated list of VLAN_IDs or ranges. Two numbers
#   separated by a colon indicate a range.

VLAN_IDS = [
    START      = "2",
    RESERVED   = "0, 1, 4095"
]
```

By modifying that parameter you can reserve some VLANs so they aren't assigned to a Virtual Network. You can also define the first `VLAN_ID`. When a new isolated network is created, OpenNebula will find a free `VLAN_ID` from the VLAN pool. This pool is global, and it's also shared with the *802.1Q VLAN* network mode.

The following configuration attributes can be adjusted in `/var/lib/one/remotes/etc/vnm/OpenNebulaNetwork.conf`:

Parameter	Description
<code>arp_cache_poisoning</code>	Enable ARP Cache Poisoning Prevention Rules (effective only if Virtual Network IP/MAC spoofing filters are enabled).
<code>keep_empty_bridges</code>	Set to true to preserve bridges with no virtual interfaces left.
<code>ovs_bridge_conf</code>	Hash Options for Open vSwitch bridge creation

Note: Remember to run `onehost sync` to deploy the file to all the nodes.

9.6.2 Defining an Open vSwitch Network

To create an Open vSwitch network, include the following information:

Attribute	Value	Mandatory
VN_MAD	ovswitch	YES
PHYDEV	Name of the physical network device that will be attached to the bridge	NO
BRIDGE	Name of the Open vSwitch bridge to use	YES
VLAN_ID	The VLAN ID. If this attribute is not defined a VLAN ID will be generated if <code>AUTOMATIC_VLAN_ID</code> is set to YES.	NO
AUTO-MATIC_VLAN_ID	If <code>VLAN_ID</code> has been defined, this attribute is ignored. Set to YES if you want OpenNebula to generate an automatic VLAN ID.	NO

The following example defines an Open vSwitch network

```

NAME      = "ovswitch_net"
VN_MAD    = "ovswitch"
BRIDGE    = vbr1
VLAN_ID   = 50 # optional
...

```

Multiple VLANs (VLAN trunking)

VLAN trunking is also supported by adding the following tag to the NIC element in the VM template or to the virtual network template:

- `VLAN_TAGGED_ID`: Specify a range of VLANs to tag, for example: `1, 10, 30, 32, 100-200`.

9.7 Open vSwitch on VXLAN Networks

This guide describes how to use the [Open vSwitch](#) on the VXLAN networks. The specialized driver combines features of existing [Open vSwitch](#) and [VXLAN](#) drivers. It's necessary to be familiar with these two drivers, their configuration options, benefits, and drawbacks.

The VXLAN overlay network is used as a base with the Open vSwitch (instead of regular Linux bridge) on top. Traffic on the lowest level is isolated by the VXLAN encapsulation protocol, and Open vSwitch still allows to use the second level isolation by 802.1Q VLAN tags **inside the encapsulated traffic**. Main isolation is always provided by VXLAN, not 802.1Q VLANs. If 802.1Q is required to isolate the VXLAN, the driver needs to be configured with user-created 802.1Q tagged physical interface.

This hierarchy is important to understand.

9.7.1 OpenNebula Configuration

There is no configuration specific to this driver, except the options specified for [Open vSwitch](#) and [VXLAN](#).

9.7.2 Defining Open vSwitch on VXLAN Network

To create a network include the following information:

Attribute	Value	Mandatory
VN_MAD	ovswitch_vxlan	YES
PHYDEV	Name of the physical network device that will be attached to the bridge.	YES
BRIDGE	Name of the Open vSwitch bridge to use	NO
OUTER_VLAN_ID	The outer VXLAN network ID.	NO
AUTO-MATIC_OUTER_VLAN_ID	If <code>OUTER_VLAN_ID</code> has been defined, this attribute is ignored. Set to YES if you want OpenNebula to generate an automatic ID.	NO
VLAN_ID	The inner 802.1Q VLAN ID. If this attribute is not defined a VLAN ID will be generated if <code>AUTOMATIC_VLAN_ID</code> is set to YES.	NO
AUTO-MATIC_VLAN_ID	If <code>VLAN_ID</code> has been defined, this attribute is ignored. Set to YES if you want OpenNebula to generate an automatic VLAN ID.	NO
MTU	The MTU for the VXLAN interface and bridge	NO

The following example defines an Open vSwitch network

```
NAME      = "ovsvx_net"
VN_MAD    = "ovswitch_vxlan"
PHYDEV    = eth0
BRIDGE    = ovsvxbr0.10000
OUTER_VLAN_ID = 10000 # VXLAN VNI
VLAN_ID   = 50      # optional
...
```

In this scenario, the driver will check for the existence of bridge `ovsvxbr0.10000`. If it doesn't exist, it will be created. Also, the VXLAN interface `eth0.10000` will be created and attached to the Open vSwitch bridge `ovsvxbr0.10000`. When a virtual machine is instantiated, its bridge ports will be tagged with 802.1Q VLAN 50.

REFERENCES

10.1 Overview

This Chapter covers references that apply to the configuration of OpenNebula to interact smoothly and efficiently with other datacenter components, as well as information on where are the log files, the database tool, and all the configuration parameters of the OpenNebula core daemon.

10.1.1 How Should I Read This Chapter

The *oned.conf* file is the main OpenNebula configuration file, and it is essential to tweak the performance and behavior of your OpenNebula installation. The section *Large Deployments* contains more helpful pointers to tune the OpenNebula performance.

Read *Logging and Debugging* for a complete reference on how to use log files, and how to adjust the verbosity and log subsystem.

For database maintenance operations, use the *command line tool onedb*. It can be used to get information from an OpenNebula database, upgrade it, or fix inconsistency problems.

10.1.2 Hypervisor Compatibility

This chapter applies to all the hypervisors.

10.2 ONED Configuration

The OpenNebula daemon `oned` manages the cluster nodes, virtual networks, virtual machines, users, groups and storage datastores. The configuration file for the daemon is called `oned.conf` and it is placed inside the `/etc/one` directory. In this reference document we describe all the format and options that can be specified in `oned.conf`.

10.2.1 Daemon Configuration Attributes

- `MANAGER_TIMER` : Time in seconds the core uses to evaluate periodical functions. `MONITORING_INTERVAL` cannot have a smaller value than `MANAGER_TIMER`.
- `MONITORING_INTERVAL_HOST` : Time in seconds between each HOST monitorization.
- `MONITORING_INTERVAL_VM` : Time in seconds between each VMs monitorization.
- `MONITORING_INTERVAL_DATASTORE` : Time in seconds between each DATASTORE monitorization.

- `MONITORING_INTERVAL_MARKET` : Time in seconds between each MARKETPLACE monitorization.
- `MONITORING_THREADS` : Max. number of threads used to process monitor messages
- `HOST_PER_INTERVAL`: Number of hosts monitored in each interval.
- `HOST_MONITORING_EXPIRATION_TIME`: Time, in seconds, to expire monitoring information. Use 0 to disable HOST monitoring recording.
- `VM_INDIVIDUAL_MONITORING`: VM monitoring information is obtained along with the host information. For some custom monitor drivers you may need activate the individual VM monitoring process.
- `VM_PER_INTERVAL`: Number of VMs monitored in each interval.
- `VM_MONITORING_EXPIRATION_TIME`: Time, in seconds, to expire monitoring information. Use 0 to disable VM monitoring recording.
- `SCRIPTS_REMOTE_DIR`: Remote path to store the monitoring and VM management script.
- `PORT` : Port where oned will listen for xml-rpc calls.
- `LISTEN_ADDRESS`: Host IP to listen on for xmlrpc calls (default: all IPs).
- `DB` : Vector of configuration attributes for the database back-end.
 - `backend` : Set to `sqlite` or `mysql`. Please visit the [MySQL configuration guide](#) for more information.
 - `server` (MySQL only): Host name or an IP address for the MySQL server.
 - `user` (MySQL only): MySQL user's login ID.
 - `passwd` (MySQL only): MySQL user's password.
 - `db_name` (MySQL only): MySQL database name.
 - `connections` (MySQL only): number of max. connections to MySQL server.
- `VNC_PORTS` : VNC port pool for automatic VNC port assignment, if possible the port will be set to `START + VMID`. Refer to the VM template reference for further information:
 - `start`: first port to assign
 - `reserved`: comma separated list of reserved ports or ranges. Two numbers separated by a colon indicate a range.
- `VM_SUBMIT_ON_HOLD` : Forces VMs to be created on hold state instead of pending. Values: YES or NO.
- `API_LIST_ORDER` : Sets order (by ID) of elements in list API calls (e.g. `onevm list`). Values: ASC (ascending order) or DESC (descending order).
- `LOG` : Configure the logging system
 - `SYSTEM` : Can be either `file` (default), `syslog` or `std`
 - `DEBUG_LEVEL` : Sets the level of verbosity of the log messages. Possible values are:

DEBUG_LEVEL	Meaning
0	ERROR
1	WARNING
2	INFO
3	DEBUG

Example of this section:

```

#*****
# Daemon configuration attributes
#*****

LOG = [
    SYSTEM      = "file",
    DEBUG_LEVEL = 3
]

#MANAGER_TIMER = 15

MONITORING_INTERVAL_HOST = 180
MONITORING_INTERVAL_VMS  = 180
MONITORING_INTERVAL_DATASTORE = 300
MONITORING_INTERVAL_MARKET   = 600

MONITORING_THREADS = 50

#HOST_PER_INTERVAL           = 15
#HOST_MONITORING_EXPIRATION_TIME = 43200

#VM_INDIVIDUAL_MONITORING    = "no"
#VM_PER_INTERVAL            = 5
#VM_MONITORING_EXPIRATION_TIME = 14400

SCRIPTS_REMOTE_DIR=/var/tmp/one

PORT = 2633

LISTEN_ADDRESS = "0.0.0.0"

DB = [ BACKEND = "sqlite" ]

# Sample configuration for MySQL
# DB = [ BACKEND = "mysql",
#       SERVER  = "localhost",
#       PORT    = 0,
#       USER    = "oneadmin",
#       PASSWD  = "oneadmin",
#       DB_NAME = "opennebula",
#       CONNECTIONS = 50 ]

VNC_PORTS = [
    START = 5900
#   RESERVED = "6800, 6801, 9869"
]

#VM_SUBMIT_ON_HOLD = "NO"
#API_LIST_ORDER    = "DESC"

.. _oned_conf_federation:

```

10.2.2 Federation Configuration Attributes

Control the federation capabilities of oned. Operation in a federated setup requires a special DB configuration.

- `FEDERATION` : Federation attributes.

- MODE : Operation mode of this oned.
 - * STANDALONE: not federated. This is the default operational mode
 - * MASTER: this oned is the master zone of the federation
 - * SLAVE: this oned is a slave zone
- ZONE_ID : The zone ID as returned by onezone command.
- MASTER_ONED : The xml-rpc endpoint of the master oned, e.g. <http://master.one.org:2633/RPC2>

```

#*****
# Federation configuration attributes
#*****

FEDERATION = [
    MODE = "STANDALONE",
    ZONE_ID = 0,
    MASTER_ONED = ""
]

```

10.2.3 Raft Configuration Attributes

The Raft algorithm can be tuned by several parameters in the configuration file `/etc/one/oned.conf`. Following options are available:

- LIMIT_PURGE: Number of DB log records that will be deleted on each purge.
- LOG_RETENTION: Number of DB log records kept, it determines the synchronization window across servers and extra storage space needed.
- LOG_PURGE_TIMEOUT: How often applied records are purged according the log retention value. (in seconds)
- ELECTION_TIMEOUT_MS: Timeout to start a election process if no heartbeat or log is received from leader.
- BROADCAST_TIMEOUT_MS: How often heartbeats are sent to followers.
- XMLRPC_TIMEOUT_MS: To timeout raft related API calls. To set an infinite timeout set this value to 0.

```

RAFT = [
    LIMIT_PURGE           = 100000,
    LOG_RETENTION         = 500000,
    LOG_PURGE_TIMEOUT     = 600,
    ELECTION_TIMEOUT_MS  = 2500,
    BROADCAST_TIMEOUT_MS = 500,
    XMLRPC_TIMEOUT_MS    = 450
]

```

10.2.4 Default Showback Cost

The following attributes define the default cost for Virtual Machines that don't have a CPU, MEMORY or DISK cost. This is used by the `oneshowback calculate` method.

```

#*****
# Default showback cost
#*****

```

(continues on next page)

(continued from previous page)

```

DEFAULT_COST = [
  CPU_COST      = 0,
  MEMORY_COST   = 0,
  DISK_COST     = 0
]

```

10.2.5 XML-RPC Server Configuration

- **MAX_CONN**: Maximum number of simultaneous TCP connections the server will maintain
- **MAX_CONN_BACKLOG**: Maximum number of TCP connections the operating system will accept on the server's behalf without the server accepting them from the operating system
- **KEEPALIVE_TIMEOUT**: Maximum time in seconds that the server allows a connection to be open between RPCs
- **KEEPALIVE_MAX_CONN**: Maximum number of RPCs that the server will execute on a single connection
- **TIMEOUT**: Maximum time in seconds the server will wait for the client to do anything while processing an RPC. This timeout will be also used when proxy calls to the master in a federation.
- **RPC_LOG**: Create a separated log file for xml-rpc requests, in `/var/log/one/one_xmlrpc.log`.
- **MESSAGE_SIZE**: Buffer size in bytes for XML-RPC responses.
- **LOG_CALL_FORMAT**: Format string to log XML-RPC calls. Interpreted strings:
 - `%i` - request id
 - `%m` - method name
 - `%u` - user id
 - `%U` - user name
 - `%l[number]` - param list and number of characters (optional) to print each parameter, default is 20.
Example: `%l300`
 - `%p` - user password
 - `%g` - group id
 - `%G` - group name
 - `%a` - auth token
 - `%%` - %

```

#*****
# XML-RPC server configuration
#*****

#MAX_CONN          = 15
#MAX_CONN_BACKLOG = 15
#KEEPALIVE_TIMEOUT = 15
#KEEPALIVE_MAX_CONN = 30
#TIMEOUT           = 15
#RPC_LOG           = NO
#MESSAGE_SIZE      = 1073741824
#LOG_CALL_FORMAT   = "Req:%i UID:%u %m invoked %l"

```

Warning: This functionality is only available when compiled with `xmlrpc-c` libraires ≥ 1.32 . Currently only the packages distributed by OpenNebula are linked with this library.

10.2.6 Virtual Networks

- `NETWORK_SIZE`: Here you can define the default size for the virtual networks
- `MAC_PREFIX`: Default MAC prefix to be used to create the auto-generated MAC addresses is defined here (this can be overwritten by the Virtual Network template)
- `VLAN_IDS`: VLAN ID pool for the automatic `VLAN_ID` assignment. This pool is for 802.1Q networks (Open vSwitch and 802.1Q drivers). The driver will try first to allocate `VLAN_IDS[START] + VNET_ID`
 - `start`: First `VLAN_ID` to use
 - `reserved`: Comma separated list of `VLAN_IDS` or ranges. Two numbers separated by a colon indicate a range.
- `VXLAN_IDS`: Automatic VXLAN Network ID (VNI) assignment. This is used for vxlan networks.
 - `start`: First VNI to use
 -

Note: reserved is not supported by this pool

Sample configuration:

```

#*****
# Physical Networks configuration
#*****

NETWORK_SIZE = 254

MAC_PREFIX   = "02:00"

VLAN_IDS = [
    START     = "2",
    RESERVED  = "0, 1, 4095"
]

VXLAN_IDS = [
    START     = "2"
]

```

10.2.7 Datastores

The *Storage Subsystem* allows users to set up images, which can be operative systems or data, to be used in Virtual Machines easily. These images can be used by several Virtual Machines simultaneously, and also shared with other users.

Here you can configure the default values for the Datastores and Image templates. You have more information about the templates syntax here.

- `DATASTORE_LOCATION`: Path for Datastores. It IS the same for all the hosts and front-end. It defaults to `/var/lib/one/datastores` (in self-contained mode defaults to `$ONE_LOCATION/var/datastores`). Each datastore has its own directory (called `BASE_PATH`) in the form: `$DATASTORE_LOCATION/<datastore_id>`.

You can symlink this directory to any other path if needed. `BASE_PATH` is generated from this attribute each time oned is started.

- `DATASTORE_CAPACITY_CHECK`: Checks that there is enough capacity before creating a new image. Defaults to Yes
- `DEFAULT_IMAGE_TYPE` : Default value for `TYPE` field when it is omitted in a template. Values accepted are:
 - OS: Image file holding an operating system
 - CDROM: Image file holding a CDROM
 - DATABLOCK: Image file holding a datablock, created as an empty block
- `DEFAULT_DEVICE_PREFIX` : Default value for `DEV_PREFIX` field when it is omitted in a template. The missing `DEV_PREFIX` attribute is filled when Images are created, so changing this prefix won't affect existing Images. It can be set to:

Prefix	Device type
hd	IDE
sd	SCSI
vd	KVM virtual disk

- `DEFAULT_CDROM_DEVICE_PREFIX`: Same as above but for CDROM devices.
- `DEFAULT_IMAGE_PERSISTENT`: Control the default value for the `PERSISTENT` attribute on image creation (oneimage clone, onevm disk-saveas). If blank images will inherit the persistent attribute from the base image.
- `DEFAULT_IMAGE_PERSISTENT_NEW`: Control the default value for the `PERSISTENT` attribute on image creation (oneimage create). By default images are no persistent if not set.

More information on the image repository can be found in the [Managing Virtual Machine Images](#) guide.

Sample configuration:

```
#*****
# Image Repository Configuration
#*****
#DATASTORE_LOCATION = /var/lib/one/datastores

DATASTORE_CAPACITY_CHECK = "yes"

DEFAULT_IMAGE_TYPE      = "OS"
DEFAULT_DEVICE_PREFIX   = "hd"

DEFAULT_CDROM_DEVICE_PREFIX = "hd"

#DEFAULT_IMAGE_PERSISTENT      = ""
#DEFAULT_IMAGE_PERSISTENT_NEW = "NO"
```

10.2.8 Information Collector

This driver CANNOT BE ASSIGNED TO A HOST, and needs to be used with KVM drivers. Options that can be set:

- `-a`: Address to bind the collectd socket (default 0.0.0.0)
- `-p`: UDP port to listen for monitor information (default 4124)
- `-f`: Interval in seconds to flush collected information (default 5)
- `-t`: Number of threads for the server (default 50)

- **-i**: Time in seconds of the monitorization push cycle. This parameter must be smaller than MONITORING_INTERVAL, otherwise push monitorization will not be effective.

Sample configuration:

```
IM_MAD = [
    name       = "collectd",
    executable = "collectd",
    arguments  = "-p 4124 -f 5 -t 50 -i 20" ]
```

10.2.9 Information Drivers

The information drivers are used to gather information from the cluster nodes, and they depend on the virtualizer you are using. You can define more than one information manager but make sure it has different names. To define it, the following needs to be set:

- **name**: name for this information driver.
- **executable**: path of the information driver executable, can be an absolute path or relative to `/usr/lib/one/mads/`
- **arguments**: for the driver executable, usually a probe configuration file, can be an absolute path or relative to `/etc/one/`.

For more information on configuring the information and monitoring system and hints to extend it please check the information driver configuration guide.

Sample configuration:

```
#-----
#  KVM UDP-push Information Driver Manager Configuration
#  -r number of retries when monitoring a host
#  -t number of threads, i.e. number of hosts monitored at the same time
#-----
IM_MAD = [
    NAME           = "kvm",
    SUNSTONE_NAME  = "KVM",
    EXECUTABLE     = "one_im_ssh",
    ARGUMENTS      = "-r 3 -t 15 kvm" ]
#-----
```

10.2.10 Virtualization Drivers

The virtualization drivers are used to create, control and monitor VMs on the hosts. You can define more than one virtualization driver (e.g. you have different virtualizers in several hosts) but make sure they have different names. To define it, the following needs to be set:

- **name**: name of the virtualization driver.
- **executable**: path of the virtualization driver executable, can be an absolute path or relative to `/usr/lib/one/mads/`
- **arguments**: for the driver executable
- **type**: driver type, supported drivers: xen, kvm or xml
- **default**: default values and configuration parameters for the driver, can be an absolute path or relative to `/etc/one/`

- **keep_snapshots**: do not remove snapshots on power on/off cycles and live migrations if the hypervisor supports that.
- **imported_vms_actions** : comma-separated list of actions supported for imported vms. The available actions are:
 - migrate
 - live-migrate
 - terminate
 - terminate-hard
 - undeploy
 - undeploy-hard
 - hold
 - release
 - stop
 - suspend
 - resume
 - delete
 - delete-recreate
 - reboot
 - reboot-hard
 - resched
 - unresched
 - poweroff
 - poweroff-hard
 - disk-attach
 - disk-detach
 - nic-attach
 - nic-detach
 - snap-create
 - snap-delete

For more information on configuring and setting up the Virtual Machine Manager Driver please check the section that suits you:

- *KVM Driver*
- *vCenter Driver*

Sample configuration:

```
#-----
# Virtualization Driver Configuration
#-----
```

(continues on next page)

(continued from previous page)

```

VM_MAD = [
  NAME           = "kvm",
  SUNSTONE_NAME  = "KVM",
  EXECUTABLE     = "one_vmm_exec",
  ARGUMENTS     = "-t 15 -r 0 kvm",
  DEFAULT       = "vmm_exec/vmm_exec_kvm.conf",
  TYPE          = "kvm",
  KEEP_SNAPSHOTS = "no",
  IMPORTED_VMS_ACTIONS = "terminate, terminate-hard, hold, release, suspend,
                          resume, delete, reboot, reboot-hard, resched, unresched, disk-attach,
                          disk-detach, nic-attach, nic-detach, snap-create, snap-delete"
]

```

10.2.11 Transfer Driver

The transfer drivers are used to transfer, clone, remove and create VM images. The default TM_MAD driver includes plugins for all supported storage modes. You may need to modify the TM_MAD to add custom plugins.

- **executable:** path of the transfer driver executable, can be an absolute path or relative to `/usr/lib/one/mads/`
- **arguments:** for the driver executable:
 - **-t:** number of threads, i.e. number of transfers made at the same time
 - **-d:** list of transfer drivers separated by commas, if not defined all the drivers available will be enabled

For more information on configuring different storage alternatives *please check the storage configuration guide*.

Sample configuration:

```

#-----
# Transfer Manager Driver Configuration
#-----

TM_MAD = [
  EXECUTABLE = "one_tm",
  ARGUMENTS = "-t 15 -d dummy,lvm,shared,fs_lvm,qcow2,ssh,ceph,dev,vcenter,iscsi_
↳ libvirt"
]

```

The configuration for each driver is defined in the TM_MAD_CONF section. These values are used when creating a new datastore and should not be modified since they define the datastore behavior.

- **name** : name of the transfer driver, listed in the `-d` option of the TM_MAD section
- **ln_target** : determines how the persistent images will be cloned when a new VM is instantiated.
 - **NONE:** The image will be linked and no more storage capacity will be used
 - **SELF:** The image will be cloned in the Images datastore
 - **SYSTEM:** The image will be cloned in the System datastore
- **clone_target** : determines how the non persistent images will be cloned when a new VM is instantiated.
 - **NONE:** The image will be linked and no more storage capacity will be used
 - **SELF:** The image will be cloned in the Images datastore
 - **SYSTEM:** The image will be cloned in the System datastore

- **shared** : determines if the storage holding the system datastore is shared among the different hosts or not. Valid values: *yes* or *no*.
- **ds_migrate**: set if system datastore migrations are allowed for this TM. Only useful for system datastore TMs.
- **allow_orphans**: Snapshots can live without parents. It allow three values YES, NO and MIXED. The last mode, MIXED, allow to create orphans snapshots but taking in count some dependencies which can appers after making a revert snapshot action at Ceph datastores.

Sample configuration:

```
TM_MAD_CONF = [
    name           = "lvm",
    ln_target      = "NONE",
    clone_target   = "SELF",
    shared         = "yes",
    allow_orphans  = "no"
]

TM_MAD_CONF = [
    name           = "shared",
    ln_target      = "NONE",
    clone_target   = "SYSTEM",
    shared         = "yes",
    ds_migrate     = "yes"
]
```

10.2.12 Datastore Driver

The Datastore Driver defines a set of scripts to manage the storage backend.

- **executable**: path of the transfer driver executable, can be an absolute path or relative to `/usr/lib/one/mads/`
- **arguments**: for the driver executable
 - **-t** number of threads, i.e. number of repo operations at the same time
 - **-d** datastore mads separated by commas
 - **-s** system datastore tm drivers, used to monitor shared system ds

Sample configuration:

```
DATASTORE_MAD = [
    EXECUTABLE = "one_datastore",
    ARGUMENTS  = "-t 15 -d dummy,fs,lvm,ceph,dev,iscsi_libvirt,vcenter -s shared,ssh,
↪ceph,fs_lvm"
]
```

For more information on this Driver and how to customize it, please visit *its reference guide*.

10.2.13 Marketplace Driver Configuration

Drivers to manage different marketplaces, specialized for the storage back-end

- **executable**: path of the transfer driver executable, can be an absolute path or relative to `/usr/lib/one/mads/`
- **arguments** : for the driver executable

- **-t** number of threads, i.e. number of repo operations at the same time
- **-m** marketplace mads separated by commas
- **-proxy** proxy URI if required to access the internet. For example `--proxy http://1.2.3.4:5678`
- **-w** timeout in seconds to execute external commands (default unlimited)

Sample configuration:

```
MARKET_MAD = [
  EXECUTABLE = "one_market",
  ARGUMENTS  = "-t 15 -m http,s3,one"
]
```

10.2.14 Hook System

Hooks in OpenNebula are programs (usually scripts) which execution is triggered by a change in state in Virtual Machines or Hosts. The hooks can be executed either locally or remotely in the node where the VM or Host is running. To configure the Hook System the following needs to be set in the OpenNebula configuration file:

- **executable**: path of the hook driver executable, can be an absolute path or relative to `/usr/lib/one/mads/`
- **arguments** : for the driver executable, can be an absolute path or relative to `/etc/one/`

Sample configuration:

```
HM_MAD = [
  executable = "one_hm" ]
```

Virtual Machine Hooks (VM_HOOK) defined by:

- **name**: for the hook, useful to track the hook (OPTIONAL).
- **on**: when the hook should be executed,
 - **CREATE**, when the VM is created (`onevm create`)
 - **PROLOG**, when the VM is in the prolog state
 - **RUNNING**, after the VM is successfully booted
 - **UNKNOWN**, when the VM is in the unknown state
 - **SHUTDOWN**, after the VM is shutdown
 - **STOP**, after the VM is stopped (including VM image transfers)
 - **DONE**, after the VM is deleted or shutdown
 - **CUSTOM**, user defined specific STATE and LCM_STATE combination of states to trigger the hook
- **command**: path can be absolute or relative to `/usr/share/one/hooks`
- **arguments**: for the hook. You can access to VM information with \$
 - **\$ID**, the ID of the virtual machine
 - **\$TEMPLATE**, the VM template in xml and base64 encoded multiple
 - **PREV_STATE**, the previous STATE of the Virtual Machine
 - **PREV_LCM_STATE**, the previous LCM STATE of the Virtual Machine

- **remote:** values,
 - **YES**, The hook is executed in the host where the VM was allocated
 - **NO**, The hook is executed in the OpenNebula server (default)

Host Hooks (HOST_HOOK) defined by:

- **name:** for the hook, useful to track the hook (OPTIONAL)
- **on:** when the hook should be executed,
 - **CREATE**, when the Host is created (onehost create)
 - **ERROR**, when the Host enters the error state
 - **DISABLE**, when the Host is disabled
- **command:** path can be absolute or relative to /usr/share/one/hooks
- **arguments:** for the hook. You can use the following Host information:
 - **\$ID**, the ID of the host
 - **\$TEMPLATE**, the Host template in xml and base64 encoded
- **remote:** values,
 - **YES**, The hook is executed in the host
 - **NO**, The hook is executed in the OpenNebula server (default)

Sample configuration:

```
VM_HOOK = [
  name      = "advanced_hook",
  on        = "CUSTOM",
  state     = "ACTIVE",
  lcm_state = "BOOT_UNKNOWN",
  command   = "log.rb",
  arguments = "$ID $PREV_STATE $PREV_LCM_STATE" ]
```

10.2.15 Auth Manager Configuration

- **AUTH_MAD:** The *driver* that will be used to authenticate and authorize OpenNebula requests. If not defined OpenNebula will use the built-in auth policies
 - **executable:** path of the auth driver executable, can be an absolute path or relative to /usr/lib/one/mads/
 - **authn:** list of authentication modules separated by commas, if not defined all the modules available will be enabled
 - **authz:** list of authentication modules separated by commas
- **SESSION_EXPIRATION_TIME:** Time in seconds to keep an authenticated token as valid. During this time, the driver is not used. Use 0 to disable session caching
- **ENABLE_OTHER_PERMISSIONS:** Whether or not to enable the permissions for 'other'. Users in the oneadmin group will still be able to change these permissions. Values: YES or NO
- **DEFAULT_UMASK:** Similar to Unix umask, sets the default resources permissions. Its format must be 3 octal digits. For example a umask of 137 will set the new object's permissions to 640 `um- u-- ---`

Sample configuration:

```
AUTH_MAD = [
    executable = "one_auth_mad",
    authn = "ssh,x509,ldap,server_cipher,server_x509"
]

SESSION_EXPIRATION_TIME = 900

#ENABLE_OTHER_PERMISSIONS = "YES"

DEFAULT_UMASK = 177
```

The DEFAULT_AUTH can be used to point to the desired default authentication driver, for example ldap:

```
DEFAULT_AUTH = "ldap"
```

10.2.16 VM Operations Permissions

The following parameters define the operations associated to the ADMIN, MANAGE and USE permissions. Note that some VM operations may require additional permissions on other objects. Also some operations refers to a class of actions:

- disk-snapshot, includes create, delete and revert actions
- disk-attach, includes attach and detach actions
- nic-attach, includes attach and detach actions
- snapshot, includes create, delete and revert actions
- resched, includes resched and unresched actions

The list and show operations require the USE permission, this is not configurable.

In the following example you need ADMIN right on a VM to perform migrate, delete, recover... while undeploy, hold, ... need MANAGE right:

```
VM_ADMIN_OPERATIONS = "migrate, delete, recover, retry, deploy, resched"

VM_MANAGE_OPERATIONS = "undeploy, hold, release, stop, suspend, resume, reboot,
    poweroff, disk-attach, nic-attach, disk-snapshot, terminate, disk-resize,
    snapshot, updateconf, rename, resize, update, disk-saveas"

VM_USE_OPERATIONS = ""
```

10.2.17 Restricted Attributes Configuration

Users outside the oneadmin group won't be able to instantiate templates created by users outside the "oneadmin" group that include the attributes restricted by:

- **VM_RESTRICTED_ATTR**: Virtual Machine attribute to be restricted for users outside the "oneadmin" group
- **IMAGE_RESTRICTED_ATTR**: Image attribute to be restricted for users outside the "oneadmin" group
- **VNET_RESTRICTED_ATTR**: Virtual Network attribute to be restricted for users outside the "oneadmin" group when updating a reservation. These attributes are not considered for regular VNET creation.

If the VM template has been created by admins in the ‘oneadmin’ group, then users outside the ‘oneadmin’ group **can** instantiate these templates.

Sample configuration:

```

VM_RESTRICTED_ATTR = "CONTEXT/FILES"
VM_RESTRICTED_ATTR = "NIC/MAC"
VM_RESTRICTED_ATTR = "NIC/VLAN_ID"
VM_RESTRICTED_ATTR = "NIC/BRIDGE"
VM_RESTRICTED_ATTR = "NIC_DEFAULT/MAC"
VM_RESTRICTED_ATTR = "NIC_DEFAULT/VLAN_ID"
VM_RESTRICTED_ATTR = "NIC_DEFAULT/BRIDGE"
VM_RESTRICTED_ATTR = "DISK/TOTAL_BYTES_SEC"
VM_RESTRICTED_ATTR = "DISK/READ_BYTES_SEC"
VM_RESTRICTED_ATTR = "DISK/WRITE_BYTES_SEC"
VM_RESTRICTED_ATTR = "DISK/TOTAL_IOPS_SEC"
VM_RESTRICTED_ATTR = "DISK/READ_IOPS_SEC"
VM_RESTRICTED_ATTR = "DISK/WRITE_IOPS_SEC"
#VM_RESTRICTED_ATTR = "DISK/SIZE"
VM_RESTRICTED_ATTR = "DISK/ORIGINAL_SIZE"
VM_RESTRICTED_ATTR = "CPU_COST"
VM_RESTRICTED_ATTR = "MEMORY_COST"
VM_RESTRICTED_ATTR = "DISK_COST"
VM_RESTRICTED_ATTR = "PCI"
VM_RESTRICTED_ATTR = "USER_INPUTS"

#VM_RESTRICTED_ATTR = "RANK"
#VM_RESTRICTED_ATTR = "SCHED_RANK"
#VM_RESTRICTED_ATTR = "REQUIREMENTS"
#VM_RESTRICTED_ATTR = "SCHED_REQUIREMENTS"

IMAGE_RESTRICTED_ATTR = "SOURCE"

VNET_RESTRICTED_ATTR = "VN_MAD"
VNET_RESTRICTED_ATTR = "PHYDEV"
VNET_RESTRICTED_ATTR = "VLAN_ID"
VNET_RESTRICTED_ATTR = "BRIDGE"

VNET_RESTRICTED_ATTR = "AR/VN_MAD"
VNET_RESTRICTED_ATTR = "AR/PHYDEV"
VNET_RESTRICTED_ATTR = "AR/VLAN_ID"
VNET_RESTRICTED_ATTR = "AR/BRIDGE"

```

OpenNebula evaluates these attributes:

- on VM template instantiate (onemplate instantiate)
- on VM create (onevm create)
- on VM attach nic (onevm nic-attach) (for example to forbid users to use NIC/MAC)

10.2.18 Inherited Attributes Configuration

The following attributes will be copied from the resource template to the instantiated VMs. More than one attribute can be defined.

- INHERIT_IMAGE_ATTR: Attribute to be copied from the Image template to each VM/DISK.
- INHERIT_DATASTORE_ATTR: Attribute to be copied from the Datastore template to each VM/DISK.

- `INHERIT_VNET_ATTR`: Attribute to be copied from the Network template to each VM/NIC.

Sample configuration:

```
#INHERIT_IMAGE_ATTR      = "EXAMPLE"
#INHERIT_IMAGE_ATTR      = "SECOND_EXAMPLE"
#INHERIT_DATASTORE_ATTR  = "COLOR"
#INHERIT_VNET_ATTR       = "BANDWIDTH_THROTTLING"

INHERIT_DATASTORE_ATTR  = "CEPH_HOST"
INHERIT_DATASTORE_ATTR  = "CEPH_SECRET"
INHERIT_DATASTORE_ATTR  = "CEPH_USER"
INHERIT_DATASTORE_ATTR  = "CEPH_CONF"
INHERIT_DATASTORE_ATTR  = "POOL_NAME"

INHERIT_DATASTORE_ATTR  = "ISCSI_USER"
INHERIT_DATASTORE_ATTR  = "ISCSI_USAGE"
INHERIT_DATASTORE_ATTR  = "ISCSI_HOST"

INHERIT_IMAGE_ATTR      = "ISCSI_USER"
INHERIT_IMAGE_ATTR      = "ISCSI_USAGE"
INHERIT_IMAGE_ATTR      = "ISCSI_HOST"
INHERIT_IMAGE_ATTR      = "ISCSI_IQN"

INHERIT_DATASTORE_ATTR  = "GLUSTER_HOST"
INHERIT_DATASTORE_ATTR  = "GLUSTER_VOLUME"

INHERIT_DATASTORE_ATTR  = "DISK_TYPE"
INHERIT_DATASTORE_ATTR  = "ADAPTER_TYPE"

INHERIT_IMAGE_ATTR      = "DISK_TYPE"
INHERIT_IMAGE_ATTR      = "ADAPTER_TYPE"

INHERIT_VNET_ATTR       = "VLAN_TAGGED_ID"
INHERIT_VNET_ATTR       = "FILTER_IP_SPOOFING"
INHERIT_VNET_ATTR       = "FILTER_MAC_SPOOFING"
INHERIT_VNET_ATTR       = "MTU"
```

10.2.19 OneGate Configuration

- `ONEGATE_ENDPOINT`: Endpoint where OneGate will be listening. Optional.

Sample configuration:

```
ONEGATE_ENDPOINT = "http://192.168.0.5:5030"
```

10.2.20 Default Permissions for VDC ACL rules

Default ACL rules created when resource is added to a VDC. The following attributes configures the permissions granted to the VDC group for each resource types:

- `DEFAULT_VDC_HOST_ACL`: permissions granted on hosts added to a VDC.
- `DEFAULT_VDC_NET_ACL`: permissions granted on vnets added to a VDC.
- `DEFAULT_VDC_DATASTORE_ACL`: permissions granted on datastores to a VDC.

- `DEFAULT_VDC_CLUSTER_HOST_ACL`: permissions granted to cluster hosts when acluster is added to the VDC.
- `DEFAULT_VDC_CLUSTER_NET_ACL`: permissions granted to cluster vnets when acluster is added to the VDC.
- `DEFAULT_VDC_CLUSTER_DATASTORE_ACL`: permissions granted to cluster datastores when a cluster is added to the VDC.

When defining the permissions you can use "" or "-" to not add any rule to that specific resource. Also you can combine several permissions with "+", for example "MANAGE+USE". Valid permissions are USE, MANAGE or ADMIN.

Example:

```
DEFAULT_VDC_HOST_ACL      = "MANAGE"
#Adds @<gid> HOST/#<hid> MANAGE #<zid> when a host is added to the VDC.
onevdc addhost <vdc> <zid> <hid>

DEFAULT_VDC_NET_ACL       = "USE"
#Adds @<gid> NET/#<vnetid> USE #<zid> when a vnet is added to the VDC.
onevdc addvnet <vdc> <zid> <vnetid>

DEFAULT_VDC_DATASTORE_ACL = "USE"
#Adds @<gid> DATASTORE/#<dsid> USE #<zid> when a vnet is added to the VDC.
onevdc adddatastore <vdc> <zid> <dsid>

DEFAULT_VDC_CLUSTER_HOST_ACL      = "MANAGE"
DEFAULT_VDC_CLUSTER_NET_ACL       = "USE"
DEFAULT_VDC_CLUSTER_DATASTORE_ACL = "USE"
#Adds:
#@<gid> HOST/%<cid> MANAGE #<zid>
#@<gid> DATASTORE+NET/%<cid> USE #<zid>
#when a cluster is added to the VDC.
onevdc addcluster <vdc> <zid> <cid>
```

10.3 Logging & Debugging

OpenNebula provides logs for many resources. It supports three logging systems: file based logging systems, syslog logging and logging to standard error stream.

In the case of file based logging, OpenNebula keeps separate log files for each active component, all of them stored in `/var/log/one`. To help users and administrators find and solve problems, they can also access some of the error messages from the CLI or the *Sunstone GUI*.

With syslog or standard error the logging strategy is almost identical, except that the logging message change slightly their format following syslog logging conventions, and resource information.

10.3.1 Configure the Logging System

The Logging system can be changed in `/etc/one/oned.conf`, specifically under the LOG section. Two parameters can be changed: `SYSTEM`, which is 'syslog', 'file' (default) or 'std', and the `DEBUG_LEVEL` is the logging verbosity.

For the scheduler the logging system can be changed in the exact same way. In this case the configuration is in `/etc/one/sched.conf`.

10.3.2 Log Resources

There are different log resources corresponding to different OpenNebula components:

- **ONE Daemon:** The core component of OpenNebula dumps all its logging information onto `/var/log/one/oned.log`. Its verbosity is regulated by `DEBUG_LEVEL` in `/etc/one/oned.conf`. By default the one start up scripts will backup the last oned.log file using the current time, e.g. `oned.log.20121011151807`. Alternatively, this resource can be logged to the syslog.
- **Scheduler:** All the scheduler information is collected into the `/var/log/one/sched.log` file. This resource can also be logged to the syslog.
- **Virtual Machines:** The information specific of the VM will be dumped in the log file `/var/log/one/<vmid>.log`. All VMs controlled by OpenNebula have their folder, `/var/lib/one/vms/<VID>`, or to the syslog/stderr if enabled. You can find the following information in it:
 - **Deployment description files :** Stored in `deployment.<EXECUTION>`, where `<EXECUTION>` is the sequence number in the execution history of the VM (deployment.0 for the first host, deployment.1 for the second and so on).
 - **Transfer description files :** Stored in `transfer.<EXECUTION>.<OPERATION>`, where `<EXECUTION>` is the sequence number in the execution history of the VM, `<OPERATION>` is the stage where the script was used, e.g. `transfer.0.prolog`, `transfer.0.epilog`, or `transfer.1.cleanup`.
- **Drivers:** Each driver can have activated its `ONE_MAD_DEBUG` variable in their `RC` files. If so, error information will be dumped to `/var/log/one/name-of-the-driver-executable.log`; log information of the drivers is in `oned.log`.

10.3.3 Logging Format

The structure of an OpenNebula message for a file based logging system is the following:

```
date [Z<zone_id>][module][log_level]: message body
```

In the case of syslog it follows the standard:

```
date hostname process[pid]: [Z<zone_id>][module][log_level]: message
```

Where the `zone_id` is the ID of the zone in the federation, 0 for single zone set ups, `module` is any of the internal OpenNebula components: `VMM`, `ReM`, `TM`, etc. And the `log_level` is a single character indicating the log level: `I` for info, `D` for debug, etc.

For the syslog, OpenNebula will also log the Virtual Machine events like this:

```
date hostname process[pid]: [VM id][Z<zone_id>][module][log_level]: message
```

And similarly for the stderr logging, for oned and VM events the format are:

```
date [Z<zone_id>][module][log_level]: message
date [VM id][Z<zone_id>][module][log_level]: message
```

10.3.4 Virtual Machine Errors

Virtual Machine errors can be checked by the owner or an administrator using the `onevm show` output:

```

$ onevm show 0
VIRTUAL MACHINE 0 INFORMATION
ID                : 0
NAME              : one-0
USER              : oneadmin
GROUP             : oneadmin
STATE             : ACTIVE
LCM_STATE         : PROLOG_FAILED
START TIME        : 07/19 17:44:20
END TIME          : 07/19 17:44:31
DEPLOY ID        : -

VIRTUAL MACHINE MONITORING
NET_TX            : 0
NET_RX            : 0
USED MEMORY       : 0
USED CPU          : 0

VIRTUAL MACHINE TEMPLATE
CONTEXT=[
  FILES=/tmp/some_file,
  TARGET=hdb ]
CPU=0.1
ERROR=[
  MESSAGE="Error excuting image transfer script: Error copying /tmp/some_file to /var/
↳ lib/one/0/images/isofiles",
  TIMESTAMP="Tue Jul 19 17:44:31 2011" ]
MEMORY=64
NAME=one-0
VMID=0

VIRTUAL MACHINE HISTORY
SEQ      HOSTNAME ACTION      START      TIME      PTIME
  0      host01   none    07/19 17:44:31 00 00:00:00 00 00:00:00

```

Here the error tells that it could not copy a file, most probably it does not exist.

Alternatively you can also check the log files for the VM at `/var/log/one/<vmid>.log`.

Note: Check the Virtual Machines High Availability Guide, to learn how to recover a VM in fail state.

10.3.5 Host Errors

Host errors can be checked executing the `onehost show` command:

```

$ onehost show 1
HOST 1 INFORMATION
ID                : 1
NAME              : host01
STATE             : ERROR
IM_MAD            : im_kvm
VM_MAD            : vmm_kvm
TM_MAD            : tm_shared

HOST SHARES

```

(continues on next page)

(continued from previous page)

```

MAX MEM           : 0
USED MEM (REAL)   : 0
USED MEM (ALLOCATED) : 0
MAX CPU           : 0
USED CPU (REAL)   : 0
USED CPU (ALLOCATED) : 0
TOTAL VMS        : 0

MONITORING INFORMATION
ERROR=[
  MESSAGE="Error monitoring host 1 : MONITOR FAILURE 1 Could not update remotes",
  TIMESTAMP="Tue Jul 19 17:17:22 2011" ]

```

The error message appears in the ERROR value of the monitoring. To get more information you can check `/var/log/one/oned.log`. For example for this error we get in the log file:

```

Tue Jul 19 17:17:22 2011 [InM][I]: Monitoring host host01 (1)
Tue Jul 19 17:17:22 2011 [InM][I]: Command execution fail: scp -r /var/lib/one/
↳remotes/. host01:/var/tmp/one
Tue Jul 19 17:17:22 2011 [InM][I]: ssh: Could not resolve hostname host01: nodename_
↳nor servname provided, or not known
Tue Jul 19 17:17:22 2011 [InM][I]: lost connection
Tue Jul 19 17:17:22 2011 [InM][I]: ExitCode: 1
Tue Jul 19 17:17:22 2011 [InM][E]: Error monitoring host 1 : MONITOR FAILURE 1 Could_
↳not update remotes

```

From the execution output we notice that the host name is not known, probably a mistake naming the host.

10.4 Onedb Tool

This section describes the `onedb` CLI tool. It can be used to get information from an OpenNebula database, upgrade it, or fix inconsistency problems.

10.4.1 Connection Parameters

The command `onedb` can connect to any SQLite or MySQL database. Visit the `onedb` man page for a complete reference. These are two examples for the default databases:

```

$ onedb <command> -v --sqlite /var/lib/one/one.db
$ onedb <command> -v -S localhost -u onedadmin -p onedadmin -d opennebula

```

10.4.2 onedb fsck

Checks the consistency of the DB, and fixes the problems found. For example, if the machine where OpenNebula is running crashes, or loses connectivity with the database, you may have a wrong number of VMs running in a Host, or incorrect usage quotas for some users.

```

$ onedb fsck --sqlite /var/lib/one/one.db
Sqlite database backup stored in /var/lib/one/one.db.bck
Use 'onedb restore' or copy the file back to restore the DB.

```

(continues on next page)

(continued from previous page)

```

Host 0 RUNNING_VMS has 12   is  11
Host 0 CPU_USAGE has 1200  is 1100
Host 0 MEM_USAGE has 1572864 is 1441792
Image 0 RUNNING_VMS has 6   is  5
User 2 quotas: CPU_USED has 12   is 11.0
User 2 quotas: MEMORY_USED has 1536   is 1408
User 2 quotas: VMS_USED has 12   is 11
User 2 quotas: Image 0 RVMS has 6   is 5
Group 1 quotas: CPU_USED has 12   is 11.0
Group 1 quotas: MEMORY_USED has 1536   is 1408
Group 1 quotas: VMS_USED has 12   is 11
Group 1 quotas: Image 0 RVMS has 6   is 5

Total errors found: 12

```

If onedb fsck shows the following error message:

```
[UNREPAIRED] History record for VM <<vid>> seq # <<seq>> is not closed (etime = 0)
```

This is due to [bug #4000](#). It means that when using accounting or showback, the etime (end-time) of that history record is not set, and the VM is considered as still running when it should not. To fix this problem, locate the time when the VM was shut down in the logs and then execute this patch to edit the times manually:

```

$ onedb patch -v --sqlite /var/lib/one/one.db /usr/lib/one/ruby/onedb/patches/history_
↪times.rb
Version read:
Shared tables 4.11.80 : OpenNebula 5.0.1 daemon bootstrap
Local tables 4.13.85 : OpenNebula 5.0.1 daemon bootstrap

Sqlite database backup stored in /var/lib/one/one.db_2015-10-13_12:40:2.bck
Use 'onedb restore' or copy the file back to restore the DB.

> Running patch /usr/lib/one/ruby/onedb/patches/history_times.rb
This tool will allow you to edit the timestamps of VM history records, used to
↪calculate accounting and showback.
VM ID: 1
History sequence number: 0

STIME  Start time      : 2015-10-08 15:24:06 UTC
PSTIME Prolog start time : 2015-10-08 15:24:06 UTC
PETIME Prolog end time   : 2015-10-08 15:24:29 UTC
RSTIME Running start time : 2015-10-08 15:24:29 UTC
RETIME Running end time  : 2015-10-08 15:42:35 UTC
ESTIME Epilog start time  : 2015-10-08 15:42:35 UTC
EETIME Epilog end time    : 2015-10-08 15:42:36 UTC
ETIME  End time         : 2015-10-08 15:42:36 UTC

To set new values:
empty to use current value; <YYYY-MM-DD HH:MM:SS> in UTC; or 0 to leave unset (open
↪history record).
STIME  Start time      : 2015-10-08 15:24:06 UTC
New value      :

ETIME  End time       : 2015-10-08 15:42:36 UTC
New value      :

```

(continues on next page)

(continued from previous page)

```

The history record # 0 for VM 1 will be updated with these new values:
STIME  Start time      : 2015-10-08 15:24:06 UTC
PSTIME Prolog start time : 2015-10-08 15:24:06 UTC
PETIME Prolog end time   : 2015-10-08 15:24:29 UTC
RSTIME Running start time : 2015-10-08 15:24:29 UTC
RETIME Running end time  : 2015-10-08 15:42:35 UTC
ESTIME Epilog start time  : 2015-10-08 15:42:35 UTC
EETIME Epilog end time    : 2015-10-08 15:42:36 UTC
ETIME  End time          : 2015-10-08 15:42:36 UTC

Confirm to write to the database [Y/n]: y
> Done

> Total time: 27.79s

```

10.4.3 onedb version

Prints the current DB version.

```

$ onedb version --sqlite /var/lib/one/one.db
3.8.0

```

Use the `-v` flag to see the complete version and comment.

```

$ onedb version -v --sqlite /var/lib/one/one.db
Version: 3.8.0
Timestamp: 10/19 16:04:17
Comment: Database migrated from 3.7.80 to 3.8.0 (OpenNebula 3.8.0) by onedb command.

```

If the MySQL database password contains special characters, such as `@` or `#`, the `onedb` command will fail to connect to it.

The workaround is to temporarily change the `oneadmin`'s password to an ASCII string. The `set password` statement can be used for this:

```

$ mysql -u oneadmin -p

mysql> SET PASSWORD = PASSWORD('newpass');

```

10.4.4 onedb history

Each time the DB is upgraded, the process is logged. You can use the `history` command to retrieve the upgrade history.

```

$ onedb history -S localhost -u oneadmin -p oneadmin -d opennebula
Version: 3.0.0
Timestamp: 10/07 12:40:49
Comment: OpenNebula 3.0.0 daemon bootstrap

...

Version: 3.7.80

```

(continues on next page)

(continued from previous page)

```
Timestamp: 10/08 17:36:15
Comment: Database migrated from 3.6.0 to 3.7.80 (OpenNebula 3.7.80) by onedb_
↳command.

Version: 3.8.0
Timestamp: 10/19 16:04:17
Comment: Database migrated from 3.7.80 to 3.8.0 (OpenNebula 3.8.0) by onedb command.
```

10.4.5 onedb upgrade

The upgrade process is fully documented in the [Upgrading from Previous Versions](#) guide.

10.4.6 onedb backup

Dumps the OpenNebula DB to a file.

```
$ onedb backup --sqlite /var/lib/one/one.db /tmp/my_backup.db
Sqlite database backup stored in /tmp/my_backup.db
Use 'onedb restore' or copy the file back to restore the DB.
```

10.4.7 onedb restore

Restores the DB from a backup file. Please note that this tool will only restore backups generated from the same backend, i.e. you cannot backup a SQLite database and then try to populate a MySQL one.

10.4.8 onedb sqlite2mysql

This command migrates from a sqlite database to a mysql database. The procedure to follow is:

- Stop OpenNebula
- Change the DB directive in `/etc/one/oned.conf` to use MySQL instead of SQLite
- Bootstrap the MySQL Database: `oned -i`
- Migrate the Database: `onedb sqlite2mysql -s <SQLITE_PATH> -u <MYSQL_USER> -p <MYSQL_PASS> -d <MYSQL_DB>`
- Start OpenNebula

10.4.9 onedb purge-history

Deletes all but the last 2 history records from non DONE VMs. You can specify start and end dates in case you don't want to delete all history:

```
$ onedb purge-history --start 2014/01/01 --end 2016/06/15
```

Warning: This action is done while OpenNebula is running. Make a backup of the database before executing.

10.4.10 onedb purge-done

Deletes information of machines in DONE state. `--start` and `--end` parameters can be used the same as `purge-history`:

```
$ onedb purge-done --end 2016/01
```

Warning: This action is done while OpenNebula is running. Make a backup of the database before executing.

10.4.11 onedb change-body

Changes a value from the body of an object. The possible objects are: `vm`, `host`, `vnet`, `image`, `cluster`, `document`, `group`, `marketplace`, `marketplaceapp`, `secgroup`, `template`, `vrouter` or `zone`.

You can filter the objects to modify using one of these options:

- `--id`: object id, example: 156
- `--xpath`: xpath expression, example: `TEMPLATE[count(NIC)>1]`
- `--expr`: **xpath expression, can use operators =, !=, <, >, <= or >=** examples: `UNAME=oneadmin, TEMPLATE/NIC/NIC_ID>0`

If you want to change a value use a third parameter. In case you want to delete it use `--delete` option.

Change the second network of VMs that belong to “user”:

```
$ onedb change-body vm --expr UNAME=user '/VM/TEMPLATE/NIC[NETWORK="service"]/NETWORK
↪' new_network
```

Delete cache attribute in all disks, write xml, do not modify DB:

```
$ onedb change-body vm '/VM/TEMPLATE/DISK/CACHE' --delete --dry
```

Delete cache attribute in all disks in poweroff:

```
$ onedb change-body vm --expr LCM_STATE=8 '/VM/TEMPLATE/DISK/CACHE' --delete
```

Warning: This action is done while OpenNebula is running. Make a backup of the database before executing.

10.5 Large Deployments

10.5.1 Monitoring

In KVM environments, OpenNebula supports two native monitoring systems: `ssh-pull` and `udp-push`. The former one, `ssh-pull` is the default monitoring system for OpenNebula `<= 4.2`, however from OpenNebula 4.4 onwards, the default monitoring system is the `udp-push` system. This model is highly scalable and its limit (in terms of number of VMs monitored per second) is bounded to the performance of the server running `oned` and the database server. Read more in the *Monitoring guide*.

For vCenter environments, OpenNebula uses the VI API offered by vCenter to monitor the state of the hypervisor and all the Virtual Machines running in all the imported vCenter clusters. The driver is optimized to cache common VM information.

In both environments, our scalability testing achieves the monitoring of tens of thousands of VMs in a few minutes.

10.5.2 Core Tuning

OpenNebula keeps the monitorization history for a defined time in a database table. These values are then used to draw the plots in Sunstone.

These monitorization entries can take quite a bit of storage in your database. The amount of storage used will depend on the size of your cloud, and the following configuration attributes in *oned.conf*:

- `MONITORING_INTERVAL_HOST`: Time in seconds between each monitorization. Default: 180.
- `collectd IM_MAD -i` argument (KVM only): Time in seconds of the monitorization push cycle. Default: 60.
- `HOST_MONITORING_EXPIRATION_TIME`: Time, in seconds, to expire monitoring information. Default: 12h.
- `VM_MONITORING_EXPIRATION_TIME`: Time, in seconds, to expire monitoring information. Default: 4h.

If you don't use Sunstone, you may want to disable the monitoring history, setting both expiration times to 0.

Each monitoring entry will be around 2 KB for each Host, and 4 KB for each VM. To give you an idea of how much database storage you will need to prepare, here are some examples:

Monitoring interval	Host expiration	# Hosts	Storage
20s	12h	200	850 MB
20s	24h	1000	8.2 GB

Monitoring interval	VM expiration	# VMs	Storage
20s	4h	2000	1.8 GB
20s	24h	10000	7 GB

10.5.3 API Tuning

For large deployments with lots of xmlrpc calls the default values for the xmlrpc server are too conservative. The values you can modify and its meaning are explained in *oned.conf* and the [xmlrpc-c library documentation](#). From our experience these values improve the server behavior with a high amount of client calls:

```
MAX_CONN = 240
MAX_CONN_BACKLOG = 480
```

The core is able to paginate some pool answers. This makes the memory consumption decrease and in some cases the parsing faster. By default the pagination value is 2000 objects but can be changed using the environment variable `ONE_POOL_PAGE_SIZE`. It should be bigger than 2. For example, to list VMs with a page size of 5000 we can use:

```
$ ONE_POOL_PAGE_SIZE=5000 onevm list
```

To disable pagination we can use a non numeric value:

```
$ ONE_POOL_PAGE_SIZE=disabled onevm list
```

This environment variable can be also used for Sunstone.

Also, one of the main barriers to scale opennebula is the list operation on large pools. Since OpenNebula 5.8, vm pool is listed in a *summarized* form. However we recommend to make use of the search operation to reduce the pool size returned by oned. The search operation is available for the VM pool since version 5.8.

10.5.4 Driver Tuning

OpenNebula drivers have by default 15 threads. This is the maximum number of actions a driver can perform at the same time, the next actions will be queued. You can make this value in *oned.conf*, the driver parameter is `-t`.

10.5.5 Database Tuning

For non test installations use MySQL database. sqlite is too slow for more than a couple hosts and a few VMs.

10.5.6 Sunstone Tuning

Please refer to guide about *Configuring Sunstone for Large Deployments*.