

---

# OpenNebula.org

## OpenNebula 4.14 Design and Installation Guide

*Release 4.13.80*

OpenNebula Project

July 29, 2015



## CONTENTS

<b>1</b>	<b>Building your Cloud</b>	<b>1</b>
1.1	An Overview of OpenNebula . . . . .	1
1.2	Understanding OpenNebula . . . . .	6
1.3	Planning the Installation . . . . .	13
1.4	Installing the Software . . . . .	19
1.5	Glossary . . . . .	27
<b>2</b>	<b>Quick Starts</b>	<b>29</b>
2.1	Quickstart: OpenNebula on CentOS 7 and KVM . . . . .	29
2.2	Quickstart: OpenNebula on Ubuntu 14.04 and KVM . . . . .	35
2.3	Quickstart: Create Your First VDC . . . . .	41



## BUILDING YOUR CLOUD

### 1.1 An Overview of OpenNebula

OpenNebula offers a **simple but feature-rich and flexible solution** to build and manage enterprise clouds and virtualized data centers. OpenNebula is designed to be simple. Simple to install, update and operate by the admins, and simple to use by end users. Being focused on simplicity, we integrate with existing technologies whenever possible. You'll see that OpenNebula works with MySQL, Ceph, LVM, GlusterFS, Open vSwitch, Ceph, LDAP... This allows us to deliver a light, flexible and robust cloud manager.

This introductory guide gives an overview of OpenNebula and summarizes its main benefits for the different stakeholders involved in a cloud computing infrastructure.

#### 1.1.1 What Are the Key Features Provided by OpenNebula?

You can refer to our a summarized table of [Key Features](#) or to the Detailed Features and Functionality Guide included in the documentation of each version.

#### 1.1.2 What Are the Interfaces Provided by OpenNebula?

Because no two clouds are the same, OpenNebula provides many different interfaces that can be used to interact with the functionality offered to manage physical and virtual resources. There are four main different perspectives to interact with OpenNebula:

- Cloud interfaces for **Cloud Consumers**, like EC2 Query and EBS interfaces, and a simple Sunstone cloud user view that can be used as a self-service portal.
- Administration interfaces for **Cloud Advanced Users and Operators**, like a Unix-like command line interface and the powerful Sunstone GUI.
- Extensible low-level APIs for **Cloud Integrators** in Ruby, JAVA and XMLRPC API
- A Marketplace for **Appliance Builders** with a catalog of virtual appliances ready to run in OpenNebula environments.

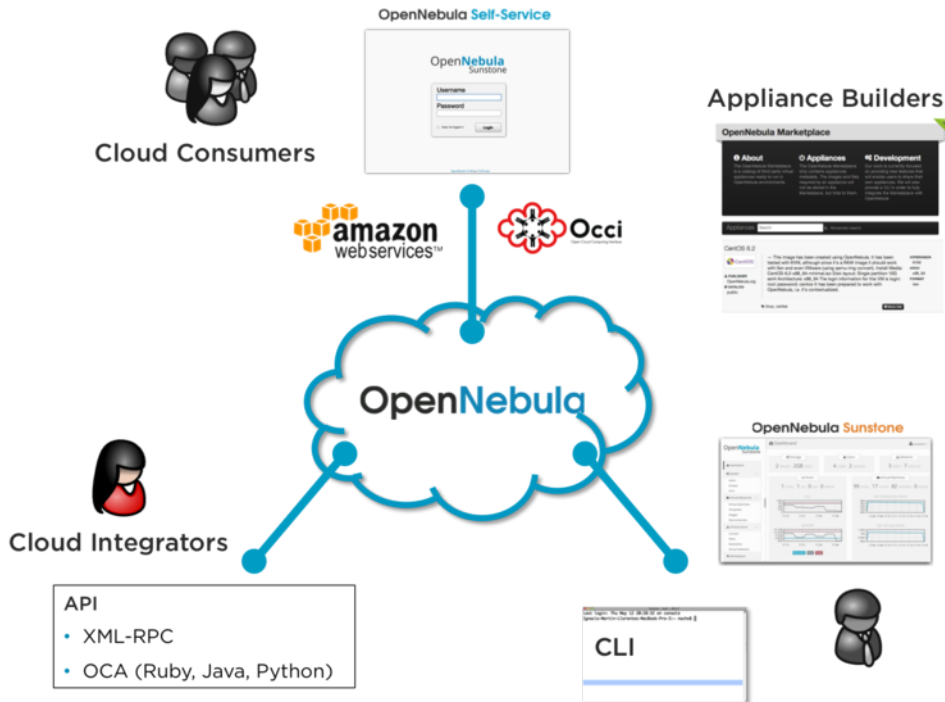

### 1.1.3 What Does OpenNebula Offer to Cloud Consumers?

OpenNebula provides a powerful, scalable and secure multi-tenant cloud platform for fast delivery and elasticity of virtual resources. Multi-tier applications can be deployed and consumed as pre-configured virtual appliances from catalogs.

- **Image Catalogs:** OpenNebula allows to store disk images in catalogs (termed datastores), that can be then used to define VMs or shared with other users. The images can be OS installations, persistent data sets or empty data blocks that are created within the datastore.
- **Network Catalogs:** Virtual networks can be also be organised in network catalogs, and provide means to interconnect virtual machines. This kind of resources can be defined as IPv4, IPv6, or mixed networks, and can be used to achieve full isolation between virtual networks.
- **VM Template Catalog:** The template catalog system allows to register virtual machine definitions in the system, to be instantiated later as virtual machine instances.
- **Virtual Resource Control and Monitoring:** Once a template is instantiated to a virtual machine, there are a number of operations that can be performed to control lifecycle of the virtual machine instances, such as migration (live and cold), stop, resume, cancel, poweroff, etc.
- **Multi-tier Cloud Application Control and Monitoring:** OpenNebula allows to define, execute and manage multi-tiered elastic applications, or services composed of interconnected Virtual Machines with deployment dependencies between them and auto-scaling rules.

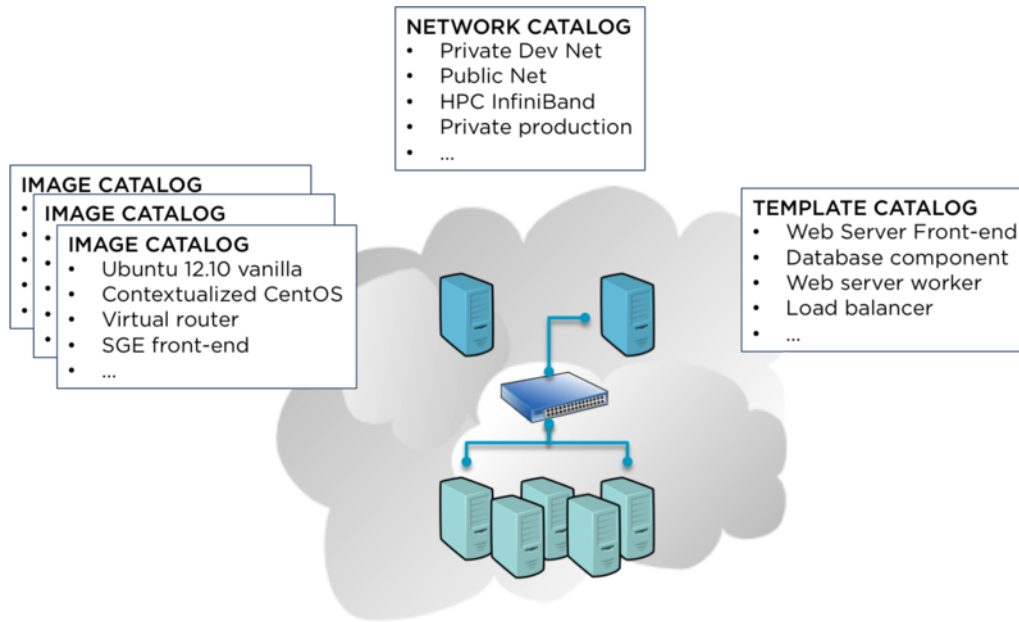

### 1.1.4 What Does OpenNebula Offer to Cloud Operators?

OpenNebula is composed of the following subsystems:

- **Users and Groups:** OpenNebula features advanced multi-tenancy with powerful users and groups management, fine-grained ACLs for resource allocation, and resource quota management to track and limit computing, storage and networking utilization.
- **Virtualization:** Various hypervisors are supported in the virtualization manager, with the ability to control the complete lifecycle of Virtual Machines and multiple hypervisors in the same cloud infrastructure.
- **Hosts:** The host manager provides complete functionality for the management of the physical hosts in the cloud.
- **Monitoring:** Virtual resources as well as hosts are periodically monitored for key performance indicators. The information can then be used by a powerful and flexible scheduler for the definition of workload and resource-aware allocation policies. You can also gain insight into application status and performance.
- **Accounting:** A Configurable accounting system to visualize and report resource usage data, to allow their integration with chargeback and billing platforms, or to guarantee a fair share of resources among users.
- **Networking:** An easily adaptable and customizable network subsystem is present in OpenNebula in order to better integrate with the specific network requirements of existing data centers and to allow full isolation between virtual machines that compose a virtualised service.
- **Storage:** The support for multiple datastores in the storage subsystem provides extreme flexibility in planning the storage backend and important performance benefits.
- **Security:** This feature is spread across several subsystems: authentication and authorization mechanisms allowing for various possible mechanisms to identify and authorize users, a powerful Access Control List mechanism allowing for different role management with fine-grained permission granting over any resource managed by OpenNebula, support for isolation at different levels...
- **High Availability:** Support for HA architectures and configurable behavior in the event of host or VM failure to provide easy-to-use and cost-effective failover solutions.
- **Clusters:** Clusters are pools of hosts that share datastores and virtual networks. Clusters are used for load balancing, high availability, and high performance computing.

- **Multiple Zones:** The Data Center Federation functionality allows for the centralized management of multiple instances of OpenNebula for scalability, isolation and multiple-site support.
- **VDCs.** An OpenNebula instance (or Zone) can be further compartmentalized in Virtual Data Centers (VDCs), which offer a fully-isolated virtual infrastructure environment where a group of users, under the control of the group administrator, can create and manage compute, storage and networking capacity.
- **Cloud Bursting:** OpenNebula gives support to build a hybrid cloud, an extension of a private cloud to combine local resources with resources from remote cloud providers. A whole public cloud provider can be encapsulated as a local resource to be able to use extra computational capacity to satisfy peak demands.
- **App Market:** OpenNebula allows the deployment of a [private centralized catalog of cloud applications](#) to share and distribute virtual appliances across OpenNebula instances

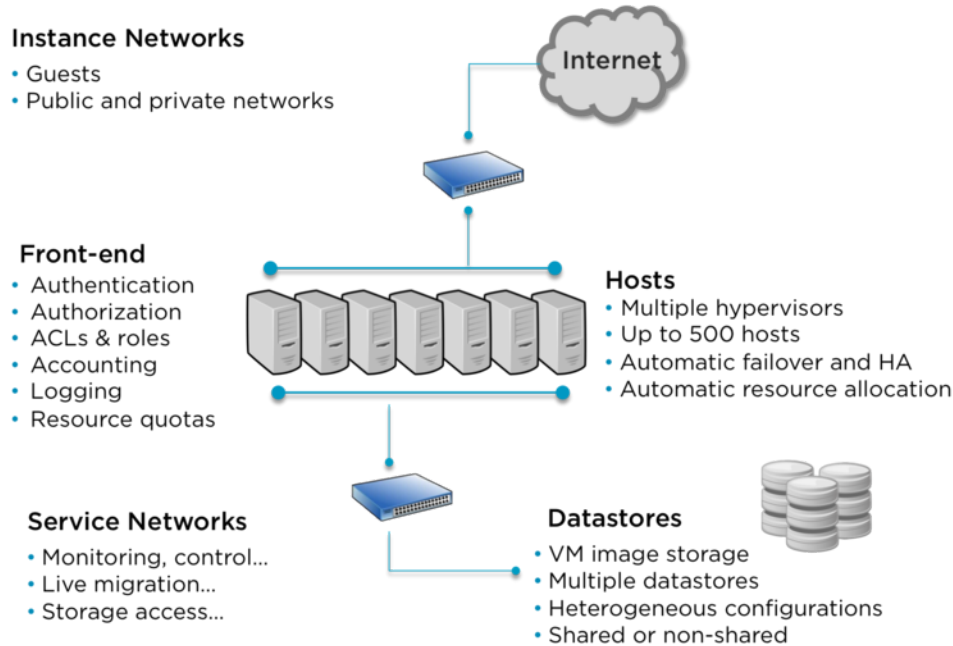

### 1.1.5 What Does OpenNebula Offer to Cloud Builders?

OpenNebula offers broad support for commodity and enterprise-grade hypervisor, monitoring, storage, networking and user management services:

- **User Management:** OpenNebula can validate users using its own internal user database based on passwords, or external mechanisms, like ssh, x509, ldap or Active Directory
- **Virtualization:** Several hypervisor technologies are fully supported, like Xen, KVM and VMware.
- **Monitoring:** OpenNebula provides its own customizable and highly scalable monitoring system and also can be integrated with external data center monitoring tools.
- **Networking:** Virtual networks can be backed up by 802.1Q VLANs, ebttables, Open vSwitch or VMware networking.
- **Storage:** Multiple backends are supported like the regular (shared or not) filesystem datastore supporting popular distributed file systems like NFS, Lustre, GlusterFS, ZFS, GPFS, MooseFS...; the VMware datastore (both regular filesystem or VMFS based) specialized for the VMware hypervisor that handle the vmdk format; the LVM datastore to store disk images in a block device form; and Ceph for distributed block device.
- **Databases:** Aside from the original sqlite backend, mysql is also supported.



- **Cloud Bursting:** Out of the box connectors are shipped to support Amazon EC2, IBM SoftLayer and Microsoft Azure cloudbursting.

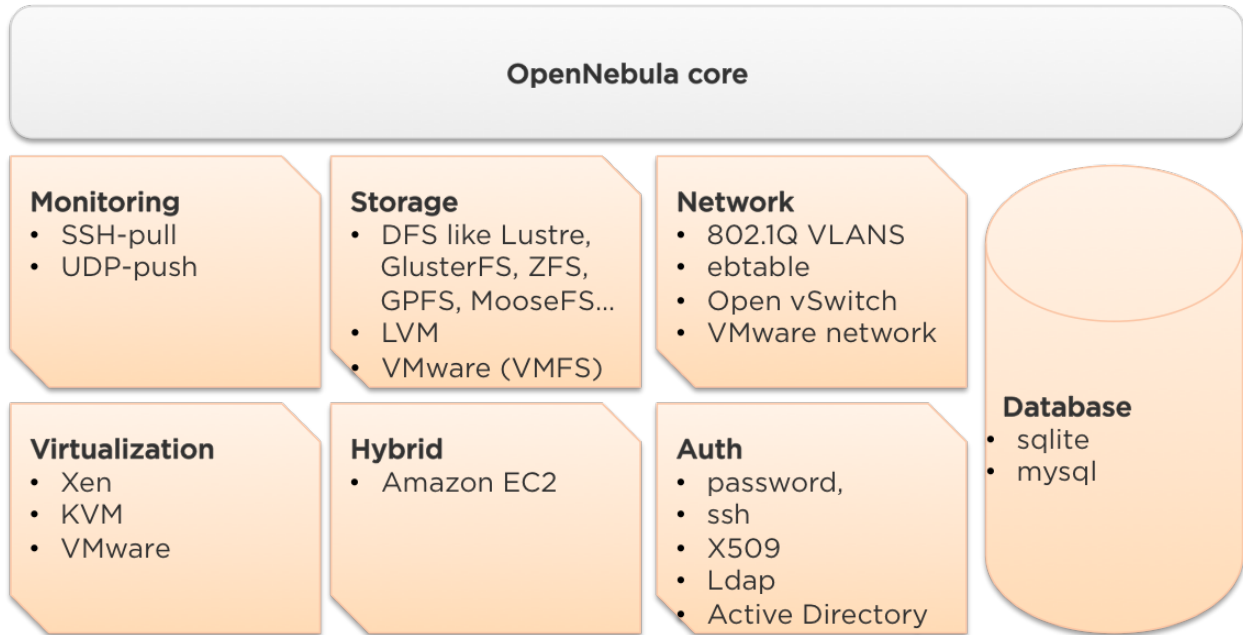

### 1.1.6 What Does OpenNebula Offer to Cloud Integrators?

OpenNebula is fully platform independent and offers many tools for cloud integrators:

- **Modular and extensible architecture** with customizable plug-ins for integration with any third-party data center service
- **API for integration** with higher level tools such as billing, self-service portals... that offers all the rich functionality of the OpenNebula core, with bindings for ruby and java.
- **Sunstone Server custom routes** to extend the sunstone server.
- **OneFlow API** to create, control and monitor multi-tier applications or services composed of interconnected Virtual Machines.
- **Hook Manager** to trigger administration scripts upon VM state change.

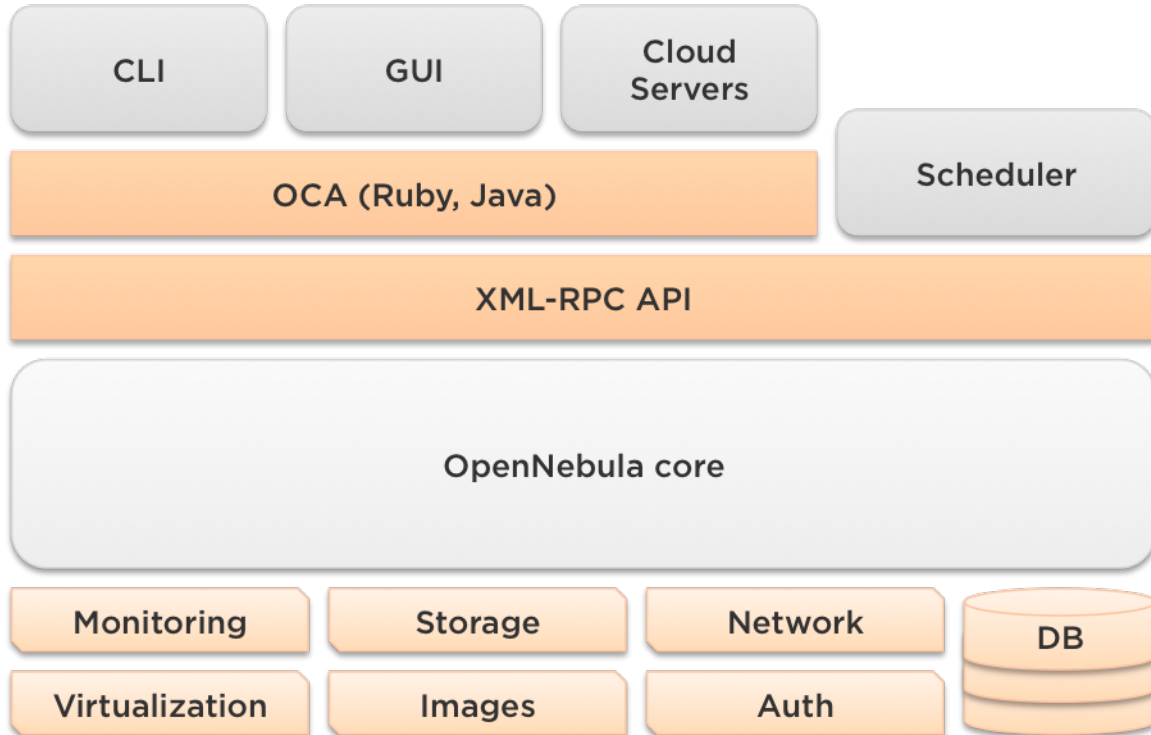

## 1.2 Understanding OpenNebula

This guide is meant for cloud architects, builders and administrators, to help them understand the OpenNebula model for managing and provisioning virtual resources. This model is a result of our collaboration with our user community during the last years. Although OpenNebula has been designed and developed to be easy to adapt to individual enterprise use cases and processes, and to perform fine-tuning of multiple aspects, OpenNebula brings a pre-defined model for cloud provisioning and consumption that offers an integrated and comprehensive framework for resource allocation and isolation in federated data centers and hybrid cloud deployments.

This guide also illustrates the three main types of cloud infrastructures that are implemented with OpenNebula:

- Data center infrastructure management
- Simple cloud provisioning model
- Advanced cloud provisioning model

### 1.2.1 Definitions

To make it easier to follow this guide, here is a list of the main resources and how we refer to them in OpenNebula:

- Physical Resources
  - **Host:** A physical machine with a hypervisor installed.
  - **Virtual Network:** Describes a Physical Network, and a set of IPs.
  - **Datastore:** Storage medium used as disk images repository or to hold images for running VMs
  - **Cluster:** Group of physical resources (Hosts, Virtual Networks and Datastores) that share common characteristics or configurations. For example, you can have the “kvm” and “vmware” Clusters, the “kvm-ceph”

and “kvm-gluster” Clusters, the “Dev” and “Production” Clusters, or the “infiniband” and “ehernet” Clusters.

- **Zone:** A single OpenNebula instance consisting of one or several Clusters. A single Data Center (DC) can hold one or several Zones. Several Zones can be federated within a single Cloud.
- Organization Resources
  - **User:** An OpenNebula user account.
  - **Group:** A group of Users.
  - **Virtual Data Center (VDC):** Defines an assignment of one or several Groups to a pool of Physical Resources. Typically this pool of Physical Resources consists of resources from one or several Clusters that could belong to different Zones or public external clouds for hybrid cloud computing.

## 1.2.2 The Infrastructure Perspective

In a small installation with a few hosts, you can use OpenNebula without giving much thought to infrastructure federation and partitioning. But for medium and large deployments you will probably want to provide some level of isolation and structure. Common large IT shops have multiple Data Centers (DCs), each one of them consisting of several physical Clusters of infrastructure resources (Hosts, Networks and Datastores). These Clusters could present different architectures and software/hardware execution environments to fulfill the needs of different workload profiles. Moreover, many organizations have access to external public clouds to build hybrid cloud scenarios where the private capacity of the Data Centers is supplemented with resources from external clouds, like Amazon AWS, to address peaks of demand. OpenNebula provides a single comprehensive framework to dynamically allocate all these available resources to the multiple groups of users.

For example, you could have two Data Centers in different geographic locations, Europe and USA West Coast, and an agreement for cloudbursting with a public cloud provider, such as Amazon, SoftLayer and/or Azure. Each Data Center runs its own zone or full OpenNebula deployment. Multiple OpenNebula Zones can be configured as a federation, and in this case they will share the same user accounts, groups, and permissions across Data Centers.

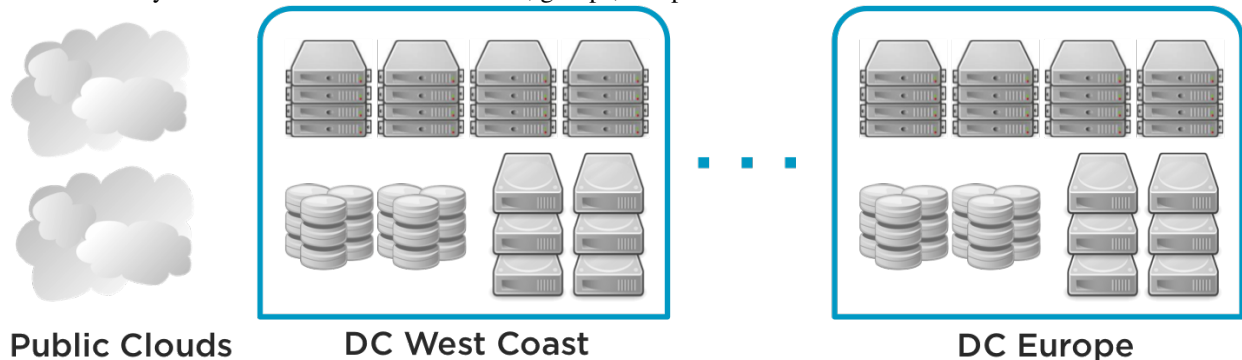

## 1.2.3 The Organizational Perspective

Users are organized into Groups (similar to what other environments call Projects, Domains, Tenants...). A Group is an authorization boundary that can be seen as a business unit if you are considering it as private cloud or as a complete new company if it is public cloud.

While Clusters are used to group Physical Resources according to common characteristics such as networking topology, or physical location, Virtual Data Centers (VDCs) allow to create “logical” pools of Physical Resources (which could belong to different Clusters and Zones) and allocate them to user Groups, so enabling their consumption.

Different authorization scenarios can be enabled with the powerful and configurable ACL system provided, from the definition of Group Admins to the privileges of the users that can deploy virtual machines. Each Group can execute different types of workload profiles with different performance and security requirements.

The following are common enterprise use cases in large cloud computing deployments:

- **On-premise Private Clouds** Serving Multiple Projects, Departments, Units or Organizations. On-premise private clouds in large organizations require powerful and flexible mechanisms to manage the access privileges to the virtual and physical infrastructure and to dynamically allocate the available resources. In these scenarios, the Cloud Administrator would define a VDC for each Department, dynamically allocating resources according to their needs, and delegating the internal administration of the Group to the Department IT Administrator.
- **Cloud Providers** Offering Virtual Private Cloud Computing. Cloud providers providing customers with a fully-configurable and isolated environment where they have full control and capacity to administer its users and resources. This combines a public cloud with the control usually seen in a personal private cloud system.

### Web Development



### Human Resources



### Big Data Analysis



For example, you can think Web Development, Human Resources, and Big Data Analysis as business units represented by Groups in a private OpenNebula cloud, and allocate them resources from your DCs and public clouds in order to create three different VDCs.

- **VDC BLUE:** VDC that allocates (ClusterA-DC\_West\_Coast + Cloudbursting) to Web Development
- **VDC RED:** VDC that allocates (ClusterB-DC\_West\_Coast + ClusterA-DC\_Europe + Cloudbursting) to Human Resources
- **VDC GREEN:** VDC that allocates (ClusterC-DC\_West\_Coast + ClusterB-DC\_Europe) to Big Data Analysis

Web Development



Human Resources



Big Data Analysis



Public Clouds

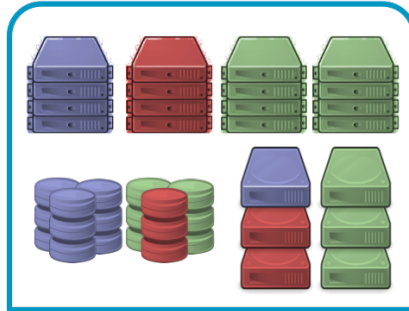

DC West Coast

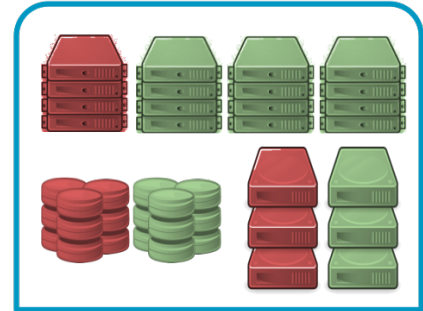

DC Europe

### 1.2.4 A Cloud Provisioning Model Based on VDCs

A VDC is a fully-isolated virtual infrastructure environment where a Group of users (or optionally several Groups of users), under the control of the Group admin, can create and manage compute and storage capacity. The users in the Group, including the Group admin, would only see the virtual resources and not the underlying physical infrastructure. The Physical Resources allocated to the Group are managed by the cloud administrator through a VDC. These resources grouped in the VDC can be dedicated exclusively to the Group, providing isolation at the physical level too.

The privileges of the Group users and the admin regarding the operations over the virtual resources created by other users can be configured. For example, in the Advanced Cloud Provisioning Case, the users can instantiate virtual machine templates to create their machines, while the admins of the Group have full control over other users' resources and can also create new users in the Group.



Create



VMs



Templates



dani



Log out



OpenNebula

## Virtual Machines

Search



<p>CentOS 6.4 Server-81</p> <p>x8 - 8GB</p> <p>Ubuntu 12.04</p> <p>192.168.1.7</p> <p>DEPLOYING (1/3) 3m ago</p>	<p>CentOS 6.4 Server-80</p> <p>x1 - 512MB</p> <p>Ubuntu 12.04</p> <p>192.168.1.6</p> <p>RUNNING 3m ago</p>	<p>CentOS 6.4 + Nginx</p> <p>x1 - 512MB</p> <p>Ubuntu 12.04</p> <p>192.168.1.5</p> <p>RUNNING 3m ago</p>
<p>Ubuntu Server 12.04-78</p> <p>x1 - 512MB</p> <p>Ubuntu 12.04</p> <p>192.168.1.4</p> <p>RUNNING 3m ago</p>	<p>Ubuntu Server 12.04-77</p> <p>x1 - 512MB</p> <p>Ubuntu 12.04</p> <p>192.168.1.3</p> <p>OFF 3m ago</p>	<p>Development VM</p> <p>x1 - 512MB</p> <p>Ubuntu 12.04</p> <p>192.168.1.2</p> <p>RUNNING 4m ago</p>

« 1 » 6 ▾

Create Virtual Machine

OpenNebula 4.5.80 by C12G Labs.

Users can then access their resources through any of the existing OpenNebula interfaces, such as the CLI, Sunstone Cloud View, OCA, or the AWS APIs. Group admins can manage their Groups through the CLI or the Group Admin View in Sunstone. Cloud administrators can manage the Groups through the CLI or Sunstone.

The Cloud provisioning model based on VDCs enables an integrated, comprehensive framework to dynamically provision the infrastructure resources in large multi-datacenter environments to different customers, business units or groups. This brings several benefits:

- Partitioning of cloud Physical Resources between Groups of users
- Complete isolation of Users, organizations or workloads
- Allocation of Clusters with different levels of security, performance or high availability
- Containers for the execution of software-defined data centers
- Way of hiding Physical Resources from Group members
- Simple federation, scalability and cloudbursting of private cloud infrastructures beyond a single cloud instance and data center

### 1.2.5 Cloud Usage Models

OpenNebula has three pre-defined User roles to implement three typical enterprise cloud scenarios:

- Data center infrastructure management
- Simple cloud provisioning model
- Advanced cloud provisioning model

In the three scenarios, the Cloud Administrators manage the physical infrastructure, creates Users and VDCs, prepares base templates and images for Users, etc

Cloud Administrators typically access to the cloud by using the CLI or the Admin View of Sunstone.

Role	Capabilities
<b>Cloud Admin.</b>	<ul style="list-style-type: none"> <li>• Operates the Cloud infrastructure (i.e. computing nodes, networking fabric, storage servers)</li> <li>• Creates and manages OpenNebula infrastructure resources: Hosts, Virtual Networks, Datastores</li> <li>• Creates and manages Multi-VM Applications (Services)</li> <li>• Creates new Groups and VDCs</li> <li>• Assigns Groups and physical resources to a VDC and sets quota limits</li> <li>• Defines base instance types to be used by the users. These types define the capacity of the VMs (memory, cpu and additional storage) and connectivity.</li> <li>• Prepare VM images to be used by the users</li> <li>• Monitor the status and health of the cloud</li> <li>• Generate activity reports</li> </ul>

### Data Center Infrastructure Management

This model is used to manage data center virtualization and to integrate and federate existing IT assets that can be in different data centers. In this usage model, Users are familiar with virtualization concepts. Except for the infrastructure resources, the web interface offers the same operations available to the Cloud Admin. These are “Advanced Users” that could be considered also as “Limited Cloud Administrators”.

Users can use the templates and images pre-defined by the cloud administrator, but usually are also allowed to create their own templates and images. They are also able to manage the life-cycle of their resources, including advanced features that may harm the VM guests, like hot-plugging of new disks, resize of Virtual Machines, modify boot parameters, etc.

Groups are used by the Cloud Administrator to isolate users, which are combined with VDCs to have allocated resources, but are not offered on-demand.

These “Advanced Users” typically access the cloud by using the CLI or the User View of Sunstone. This is not the default model configured for the group Users.

Role	Capabilities
<b>Advanced User</b>	<ul style="list-style-type: none"> <li>• Instantiates VMs using their own templates</li> <li>• Creates new templates and images</li> <li>• Manages their VMs, including advanced life-cycle features</li> <li>• Creates and manages Multi-VM Application (Services)</li> <li>• Check their usage and quotas</li> <li>• Upload SSH keys to access the VMs</li> </ul>

### Simple Cloud Provisioning Model

In the simple infrastructure provisioning model, the Cloud is offering infrastructure as a service to individual Users. Users are considered as “Cloud Users” or “Cloud Consumers”, being much more limited in their operations. These Users access a very intuitive simplified web interface that allows them to launch Virtual Machines from pre-defined Templates. They can access their VMs, and perform basic operations like shutdown. The changes made to a VM disk can be saved back, but new Images cannot be created from scratch.

Groups are used by the Cloud Administrator to isolate users, which are combined with VDCs to have allocated resources, but are not offered on-demand.

These “Cloud Users” typically access the cloud by using the Cloud View of Sunstone. This is the default model configured for the group Users.

Role	Capabilities
<b>Cloud User</b>	<ul style="list-style-type: none"> <li>• Instantiates VMs using the templates defined by the Cloud Admins and the images defined by the Cloud Admins or Group Admins.</li> <li>• Instantiates VMs using their own Images saved from a previous running VM</li> <li>• Manages their VMs, including                             <ul style="list-style-type: none"> <li>– reboot</li> <li>– power off/on (short-term switching-off)</li> <li>– delete</li> <li>– save a VM into a new Template</li> <li>– obtain basic monitor information and status (including IP addresses)</li> </ul> </li> <li>• Delete any previous VM template and disk snapshot</li> <li>• Check user account usage and quotas</li> <li>• Upload SSH keys to access the VMs</li> </ul>

### Advanced Cloud Provisioning Model

The advanced provisioning model is an extension of the previous one where the cloud provider offers VDCs on demand to Groups of Users (projects, companies, departments or business units). Each Group can define one or more users as Group Admins. These admins can create new users inside the Group, and also manage the resources of the rest of the users. A Group Admin may, for example, shutdown a VM from other user to free group quota usage.

These Group Admins typically access the cloud by using the Group Admin View of Sunstone.

The Group Users have the capabilities described in the previous scenario and typically access the cloud by using the Cloud View of Sunstone.

Role	Capabilities
<b>Group Admin.</b>	<ul style="list-style-type: none"> <li>• Creates new users in the Group</li> <li>• Operates on the Group’s virtual machines and disk images</li> <li>• Share Saved Templates with the members of the Group</li> <li>• Checks Group usage and quotas</li> </ul>



## 1.2.6 Differences with Previous Versions

In OpenNebula 4.6 the terms **Virtual Data Center (VDC)** and **Resource Providers** were introduced. A **Resource Provider** was not a separate entity, it was the way we called a Cluster assigned to a Group. The term **VDC** was used to name a Group with Resource Providers (Clusters) assigned, but was not a separate entity either.

Starting with OpenNebula 4.14, **VDCs** are a new kind of OpenNebula resource with its own ID, name, etc. and the term Resource Provider disappears. Making VDCs a first-class citizen has several advantages over the previous Group/VDC concept.

Now that VDCs are a separate entity, they can have one or more Groups added to them. This gives the Cloud Admin greater resource assignment flexibility. For example, you may have the Group Web Development added to the ‘low-performance’ VDC, and Big Data to the ‘high-performance’ VDC. After a few days, Web Development can be additionally added to the ‘high-performance’ VDC. In previous versions, this single operation would require you to write down which resources were added to the Group, to undo it later.

From the resource assignment perspective, the new VDC approach allows to create more advanced scenarios. In previous versions, the Group’s Resource Providers were whole Clusters. This had some limitations, since Clusters define the topology of your physical infrastructure in a fixed way. The Admin could not assign arbitrary resources to a Group, he had to choose from those fixed Clusters.

The new VDCs contain a list of Clusters, just like before, but they can also have individual Hosts, Virtual Networks, and Datastores. This means that a VDC can create logical groups of physical resources, that don’t have to resemble the real configuration of the physical infrastructure.

## 1.3 Planning the Installation

In order to get the most out of a OpenNebula Cloud, we recommend that you create a plan with the features, performance, scalability, and high availability characteristics you want in your deployment. This guide provides information to plan an OpenNebula installation, so you can easily architect your deployment and understand the technologies involved in the management of virtualized resources and their relationship.

### 1.3.1 Architectural Overview

OpenNebula assumes that your physical infrastructure adopts a classical cluster-like architecture with a front-end, and a set of hosts where Virtual Machines (VM) will be executed. There is at least one physical network joining all the hosts with the front-end.

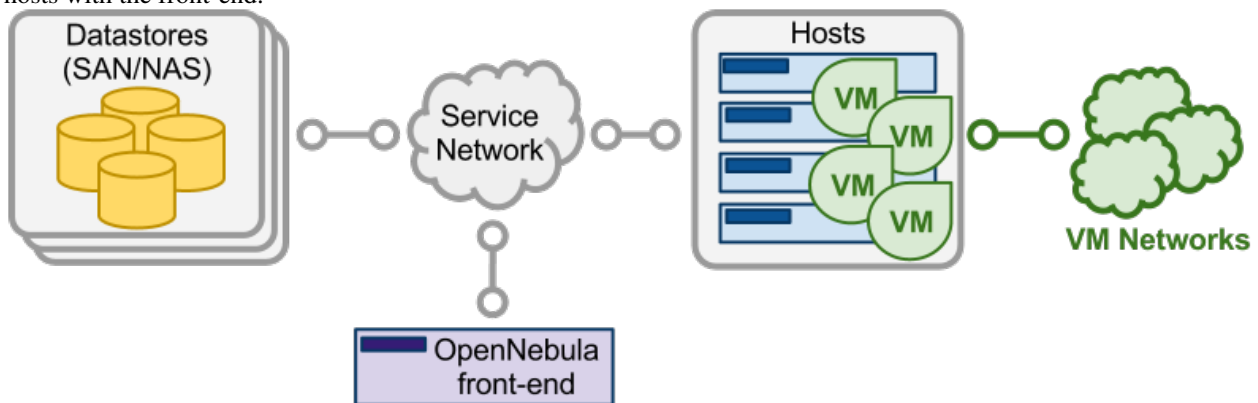

The basic components of an OpenNebula system are:

- **Front-end** that executes the OpenNebula services.

- Hypervisor-enabled **hosts** that provide the resources needed by the VMs.
- **Datastores** that hold the base images of the VMs.
- Physical **networks** used to support basic services such as interconnection of the storage servers and OpenNebula control operations, and VLANs for the VMs.

OpenNebula presents a highly modular architecture that offers broad support for commodity and enterprise-grade hypervisor, monitoring, storage, networking and user management services. This guide briefly describes the different choices that you can make for the management of the different subsystems. If your specific services are not supported we recommend to check the drivers available in the [Add-on Catalog](#). We also provide information and support about how to develop new drivers.

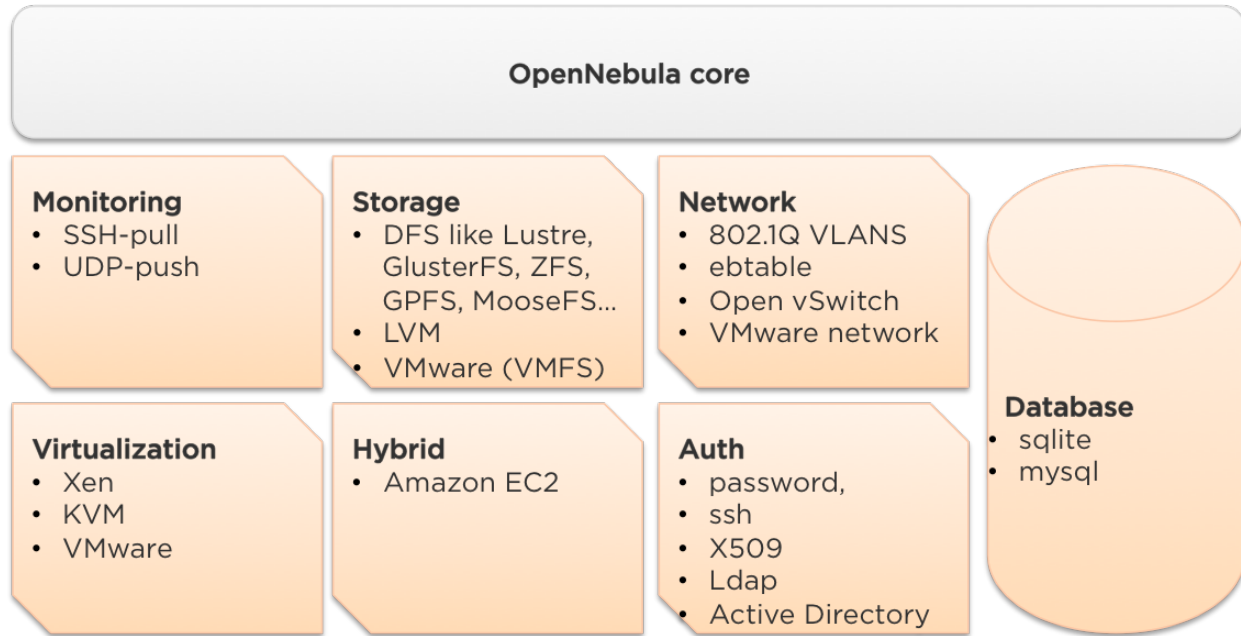

### 1.3.2 Dimensioning the Cloud

The dimension of a cloud infrastructure can be directly inferred from the expected workload in terms of VM that the cloud infrastructure must sustain. This workload it's also tricky to estimate, but this is a crucial exercise to build an efficient cloud.

The main aspects to take into account at the time of dimensioning the OpenNebula cloud are:

- **CPU**: unless overcommitment is planned the relation is that for each CPU core that one VM wants to use, a physical CPU core must exist. For instance, for a workload of 40 VMs with 2 CPUs the cloud will need 80 physical CPUs. These physical CPUs can be spread among different physical servers, for instance 10 servers with 8 cores each, or 5 server of 16 cores each. CPU dimension can be planned ahead with overcommitment, achieved using the CPU abd VCPU attributes (CPU states physical CPUs assigned to this VM, whereas VCPU stated virtual CPUs to be presented to the guest OS)
- **MEMORY**: Planning for memory is straightforward, as there are no overcommitment of memory in OpenNebula. It is always a good practice to count for a 10% overhead of the hypervisor (this is an absolut upper limit, depending on the hypervisor this can be adjusted). So, in order to sustain a VM workload of 45 VMs with 2Gb of RAM each, 90Gb of physical memory is needed. The number of physical servers is important as each one will incur on a 10% overhead due to the hypensors. For instance, 10 hypervisors with 10Gb RAM each will contribute with 9Gb each (10% of 10Gb = 1Gb), so they will be able to sustain the estimated workload.

- **STORAGE:** It is important to understand how OpenNebula uses storage, mainly the difference between system and image datastore. The image datastore is where OpenNebula stores all the images registered that can be used to create VMs, so the rule of thumb is to devote enough space for all the images that OpenNebula will have registered. The system datastore is where the VMs that are currently running store their disks, and it is trickier to estimate correctly since volatile disks come into play with no counterpart in the image datastore (volatile disks are created on the fly in the hypervisor). One valid approach is to limit the storage available to users by defining quotas in the number of maximum VMs and also the Max Volatile Storage a user can demand, and ensuring enough system and image datastore space to comply with the limit set in the quotas. In any case, currently, OpenNebula allows cloud administrators to add more system and images datastores if needed.

### 1.3.3 Front-End

The machine that holds the OpenNebula installation is called the front-end. This machine needs network connectivity to each host, and possibly access to the storage Datastores (either by direct mount or network). The base installation of OpenNebula takes less than 50MB.

OpenNebula services include:

- Management daemon (`oned`) and scheduler (`mm_sched`)
- Web interface server (`sunstone-server`)

**Warning:** Note that these components communicate through XML-RPC and may be installed in different machines for security or performance reasons

There are several certified platforms to act as front-end for each version of OpenNebula. Refer to the platform notes and chose the one that better fits your needs.

OpenNebula's default database uses `sqlite`. If you are planning a production or medium to large scale deployment, you should consider using MySQL.

If you are interested in setting up a high available cluster for OpenNebula, check the High OpenNebula Availability Guide.

The maximum number of servers (virtualization hosts) that can be managed by a single OpenNebula instance (zone) strongly depends on the performance and scalability of the underlying platform infrastructure, mainly the storage subsystem. We do not recommend more than 500 servers within each zone, but there are users with 1,000 servers in each zone. You may find interesting the following guide about how to tune OpenNebula for large deployments.

### 1.3.4 Monitoring

The monitoring subsystem gathers information relative to the hosts and the virtual machines, such as the host status, basic performance indicators, as well as VM status and capacity consumption. This information is collected by executing a set of static probes provided by OpenNebula. The output of these probes is sent to OpenNebula in two different ways:

- **UDP-push Model:** Each host periodically sends monitoring data via UDP to the frontend which collects it and processes it in a dedicated module. This model is highly scalable and its limit (in terms of number of VMs monitored per second) is bounded to the performance of the server running `oned` and the database server. Please read the UDP-push guide for more information.
- **Pull Model:** OpenNebula periodically actively queries each host and executes the probes via `ssh`. This mode is limited by the number of active connections that can be made concurrently, as hosts are queried sequentially. Please read the KVM and Xen SSH-pull guide or the ESX-pull guide for more information.

**Warning: Default:** UDP-push Model is the default IM for KVM and Xen in OpenNebula  $\geq$  4.4.

Please check the the Monitoring Guide for more details.

### 1.3.5 Virtualization Hosts

The hosts are the physical machines that will run the VMs. There are several certified platforms to act as nodes for each version of OpenNebula. Refer to the platform notes and chose the one that better fits your needs. The Virtualization Subsystem is the component in charge of talking with the hypervisor installed in the hosts and taking the actions needed for each step in the VM lifecycle.

OpenNebula natively supports three hypervisors:

- Xen
- KVM
- VMware

**Warning: Default:** OpenNebula is configured to interact with hosts running KVM.

Please check the Virtualization Guide for more details of the supported virtualization technologies.

If you are interested in failover protection against hardware and operating system outages within your virtualized IT environment, check the Virtual Machines High Availability Guide.

### 1.3.6 Storage

OpenNebula uses Datastores to handle the VM disk Images. A Datastore is any storage medium used to store disk images for VMs, previous versions of OpenNebula refer to this concept as Image Repository. Typically, a datastore will be backed by SAN/NAS servers. In general, each Datastore has to be accessible through the front-end using any suitable technology NAS, SAN or direct attached storage.

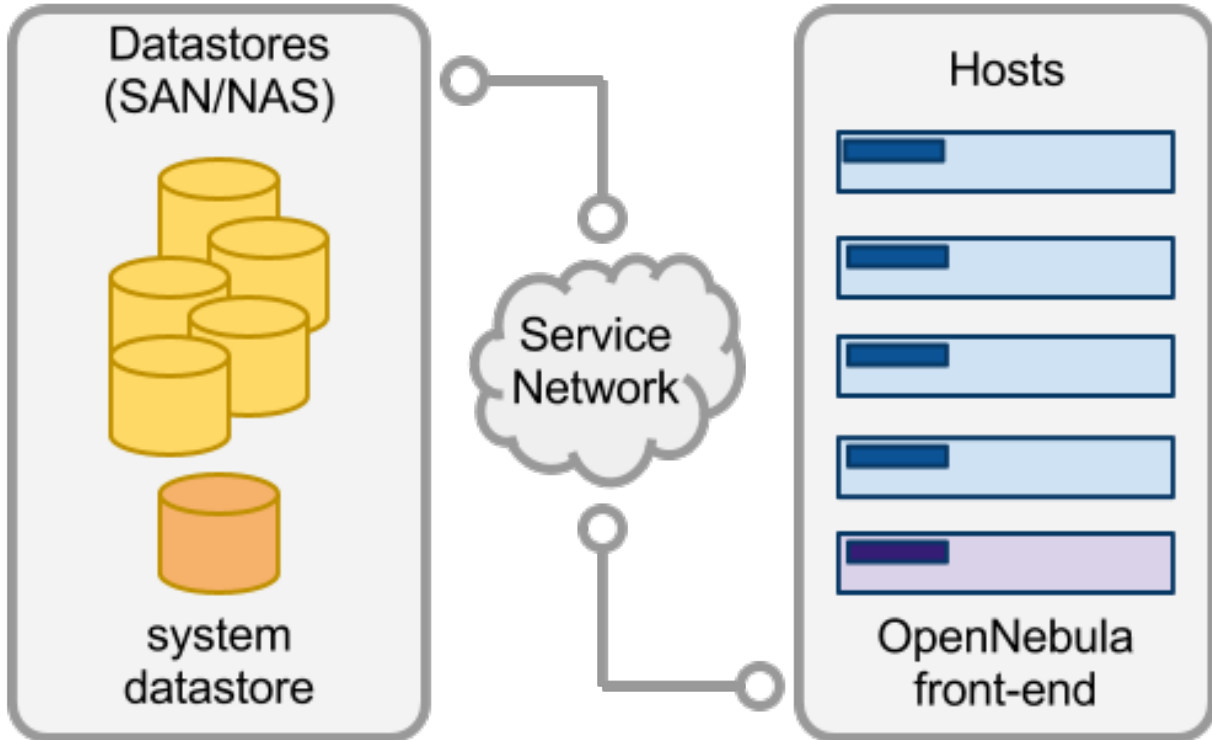

When a VM is deployed the Images are *transferred* from the Datastore to the hosts. Depending on the actual storage technology used it can mean a real transfer, a symbolic link or setting up an LVM volume.

OpenNebula is shipped with 3 different datastore classes:

- System Datastores to hold images for running VMs, depending on the storage technology used these temporal images can be complete copies of the original image, qcow deltas or simple filesystem links.
- **Image Datastores** store the disk images repository. Disk images are moved, or cloned to/from the System datastore when the VMs are deployed or shutdown; or when disks are attached or snapshotted.
- File Datastore is a special datastore used to store plain files and not disk images. The plain files can be used as kernels, ramdisks or context files.

Image datastores can be of different type depending on the underlying storage technology:

- File-system, to store disk images in a file form. The files are stored in a directory mounted from a SAN/NAS server.
- vmfs, a datastore specialized in VMFS format to be used with VMware hypervisors. Cannot be mounted in the OpenNebula front-end since VMFS is not \*nix compatible.
- LVM, The LVM datastore driver provides OpenNebula with the possibility of using LVM volumes instead of plain files to hold the Virtual Images. This reduces the overhead of having a file-system in place and thus increases performance..
- Ceph, to store disk images using Ceph block devices.

**Warning: Default:** The system and images datastores are configured to use a shared filesystem.

Please check the Storage Guide for more details.

### 1.3.7 Networking

OpenNebula provides an easily adaptable and customizable network subsystem in order to better integrate with the specific network requirements of existing datacenters. At least two different physical networks are needed:

- A **service network** is needed by the OpenNebula front-end daemons to access the hosts in order to manage and monitor the hypervisors, and move image files. It is highly recommended to install a dedicated network for this purpose.
- A **instance network** is needed to offer network connectivity to the VMs across the different hosts. To make an effective use of your VM deployments you'll probably need to make one or more physical networks accessible to them.

The OpenNebula administrator may associate one of the following drivers to each Host:

- **dummy**: Default driver that doesn't perform any network operation. Firewalling rules are also ignored.
- **fw**: Firewall rules are applied, but networking isolation is ignored.
- **802.1Q**: restrict network access through VLAN tagging, which also requires support from the hardware switches.
- **eatables**: restrict network access through Eatables rules. No special hardware configuration required.
- **ovswitch**: restrict network access with [Open vSwitch Virtual Switch](#).
- **VMware**: uses the VMware networking infrastructure to provide an isolated and 802.1Q compatible network for VMs launched with the VMware hypervisor.

**Warning: Default:** The default configuration connects the virtual machine network interface to a bridge in the physical host.

Please check the Networking Guide to find out more information of the networking technologies supported by OpenNebula.

### 1.3.8 Authentication

You can choose from the following authentication models to access OpenNebula:

- Built-in User/Password
- SSH Authentication
- X509 Authentication
- LDAP Authentication

**Warning: Default:** OpenNebula comes by default with an internal built-in user/password authentication.

Please check the Authentication Guide to find out more information of the auth technologies supported by OpenNebula.

### 1.3.9 Advanced Components

Once you have an OpenNebula cloud up and running, you can install the following advanced components:

- **Multi-VM Applications and Auto-scaling:** OneFlow allows users and administrators to define, execute and manage multi-tiered applications, or services composed of interconnected Virtual Machines with deployment dependencies between them. Each group of Virtual Machines is deployed and managed as a single entity, and is completely integrated with the advanced OpenNebula user and group management.
- **Cloud Bursting:** Cloud bursting is a model in which the local resources of a Private Cloud are combined with resources from remote Cloud providers. Such support for cloud bursting enables highly scalable hosting environments.
- **Public Cloud:** Cloud interfaces can be added to your Private Cloud if you want to provide partners or external users with access to your infrastructure, or to sell your overcapacity. The following interface provide a simple and remote management of cloud (virtual) resources at a high abstraction level: Amazon EC2 and EBS APIs.
- **Application Insight:** OneGate allows Virtual Machine guests to push monitoring information to OpenNebula. Users and administrators can use it to gather metrics, detect problems in their applications, and trigger OneFlow auto-scaling rules.

## 1.4 Installing the Software

This page shows you how to install OpenNebula from the binary packages.

### 1.4.1 Step 1. Front-end Installation

Using the packages provided in our site is the recommended method, to ensure the installation of the latest version and to avoid possible packages divergences of different distributions. There are two alternatives here: you can add **our package repositories** to your system, or visit the [software menu](#) to **download the latest package** for your Linux distribution.

Remember that we offer Quickstart guides for:

- *OpenNebula on CentOS and KVM*
- *OpenNebula on Ubuntu and KVM*

If there are no packages for your distribution, head to the [Building from Source Code](#) guide.

#### 1.1. Installing on CentOS/RHEL

Before installing:

- Activate the [EPEL](#) repo. In CentOS this can be done with the following commad:

```
# yum install epel-release
```

There are packages for the front-end, distributed in the various components that conform OpenNebula, and packages for the virtualization host.

To install a CentOS/RHEL OpenNebula front-end with packages from **our repository**, execute the following as root.

For CentOS 6.5:

```
# cat << EOT > /etc/yum.repos.d/opennebula.repo
[opennebula]
name=opennebula
baseurl=http://downloads.opennebula.org/repo/4.14/CentOS/6/x86_64
enabled=1
gpgcheck=0
```

```
EOT
# yum install opennebula-server opennebula-sunstone opennebula-ruby
```

For CentOS 7:

```
# cat << EOT > /etc/yum.repos.d/opennebula.repo
[opennebula]
name=opennebula
baseurl=http://downloads.opennebula.org/repo/4.14/CentOS/7/x86_64
enabled=1
gpgcheck=0
EOT
# yum install opennebula-server opennebula-sunstone opennebula-ruby
```

### CentOS/RHEL Package Description

These are the packages available for this distribution:

- **opennebula**: Command Line Interface
- **opennebula-server**: Main OpenNebula daemon, scheduler, etc
- **opennebula-sunstone**: OpenNebula Sunstone and EC2
- **opennebula-ruby**: Ruby Bindings
- **opennebula-java**: Java Bindings
- **opennebula-gate**: Gate server that enables communication between VMs and OpenNebula
- **opennebula-flow**: Manages services and elasticity
- **opennebula-node-kvm**: Meta-package that installs the oneadmin user, libvirt and kvm
- **opennebula-common**: Common files for OpenNebula packages

---

**Note:** The files located in `/var/lib/one/remotes` are marked as configuration files.

---

## 1.2. Installing on Debian/Ubuntu

The JSON ruby library packaged with Debian 6 is not compatible with OpenNebula. To make it work a new gem should be installed and the old one disabled. You can do so executing these commands:

```
$ sudo gem install json
$ sudo mv /usr/lib/ruby/1.8/json.rb /usr/lib/ruby/1.8/json.rb.no
```

To install OpenNebula on a Debian/Ubuntu front-end from packages from **our repositories** execute as root:

```
# wget -q -O- http://downloads.opennebula.org/repo/Debian/repo.key | apt-key add -
```

### Debian

```
# echo "deb http://downloads.opennebula.org/repo/4.14/Debian/7 stable opennebula" > /etc/apt/sources
```

### Ubuntu 14.04

```
# echo "deb http://downloads.opennebula.org/repo/4.14/Ubuntu/14.04 stable opennebula" > /etc/apt/sou
```

To install the packages on a Debian/Ubuntu front-end:



```
# apt-get update
# apt-get install opennebula opennebula-sunstone
```

### Debian/Ubuntu Package Description

These are the packages available for these distributions:

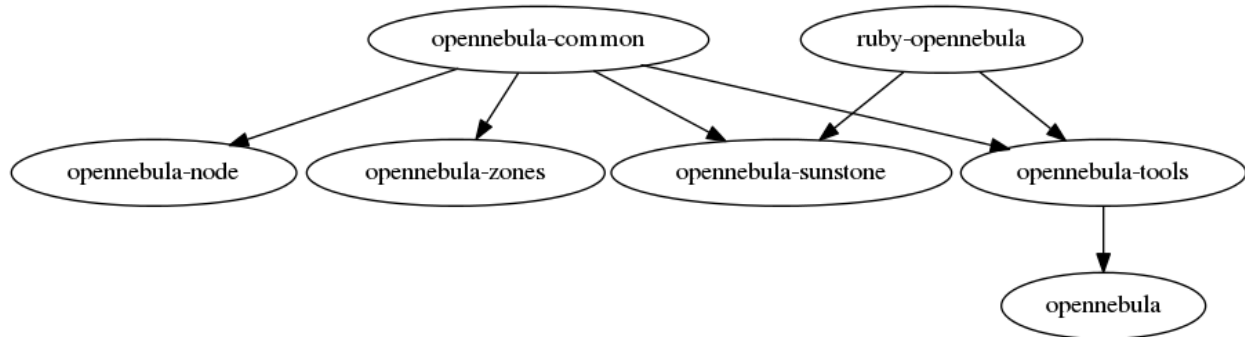

- **opennebula-common**: provides the user and common files
- **ruby-opennebula**: Ruby API
- **libopennebula-java**: Java API
- **libopennebula-java-doc**: Java API Documentation
- **opennebula-node**: prepares a node as an opennebula-node
- **opennebula-sunstone**: OpenNebula Sunstone Web Interface
- **opennebula-tools**: Command Line interface
- **opennebula-gate**: Gate server that enables communication between VMs and OpenNebula
- **opennebula-flow**: Manages services and elasticity
- **opennebula**: OpenNebula Daemon

**Note:** The following files are marked as configuration files:

- `/var/lib/one/remotes/datastore/ceph/ceph.conf`
- `/var/lib/one/remotes/datastore/lvm/lvm.conf`
- `/var/lib/one/remotes/datastore/vmfs/vmfs.conf`
- `/var/lib/one/remotes/vnm/OpenNebulaNetwork.conf`

## 1.4.2 Step 2. Ruby Runtime Installation

Some OpenNebula components need ruby libraries. OpenNebula provides a script that installs the required gems as well as some development libraries packages needed.

As root execute:

```
# /usr/share/one/install_gems
```

The previous script is prepared to detect common linux distributions and install the required libraries. If it fails to find the packages needed in your system, manually install these packages:

- sqlite3 development library

- mysql client development library
- curl development library
- libxml2 and libxslt development libraries
- ruby development library
- gcc and g++
- make

If you want to install only a set of gems for an specific component read Building from Source Code where it is explained in more depth.

### 1.4.3 Step 3. Starting OpenNebula

Log in as the `oneadmin` user follow these steps:

- If you installed from packages, you should have the `one/one_auth` file created with a randomly-generated password. Otherwise, set `oneadmin`'s OpenNebula credentials (username and password) adding the following to `~/one/one_auth` (change password for the desired password):

```
$ mkdir ~/.one
$ echo "oneadmin:password" > ~/.one/one_auth
$ chmod 600 ~/.one/one_auth
```

**Warning:** This will set the `oneadmin` password on the first boot. From that point, you must use the `'oneuser passwd'` command to change `oneadmin`'s password.

- You are ready to start the OpenNebula daemons:

```
$ one start
```

**Warning:** Remember to always start OpenNebula as `oneadmin`!

### 1.4.4 Step 4. Verifying the Installation

After OpenNebula is started for the first time, you should check that the commands can connect to the OpenNebula daemon. In the front-end, run as `oneadmin` the command `onevm`:

```
$ onevm list
  ID USER      GROUP      NAME      STAT UCPU  UMEM HOST      TIME
```

If instead of an empty list of VMs you get an error message, then the OpenNebula daemon could not be started properly:

```
$ onevm list
Connection refused - connect(2)
```

The OpenNebula logs are located in `/var/log/one`, you should have at least the files `oned.log` and `sched.log`, the core and scheduler logs. Check `oned.log` for any error messages, marked with `[E]`.

**Warning:** The first time OpenNebula is started, it performs some SQL queries to check if the DB exists and if it needs a bootstrap. You will have two error messages in your log similar to these ones, and can be ignored:

```
[ONE][I]: Checking database version.
[ONE][E]: (..) error: no such table: db_versioning
[ONE][E]: (..) error: no such table: user_pool
[ONE][I]: Bootstrapping OpenNebula database.
```

After installing the OpenNebula packages in the front-end the following directory structure will be used

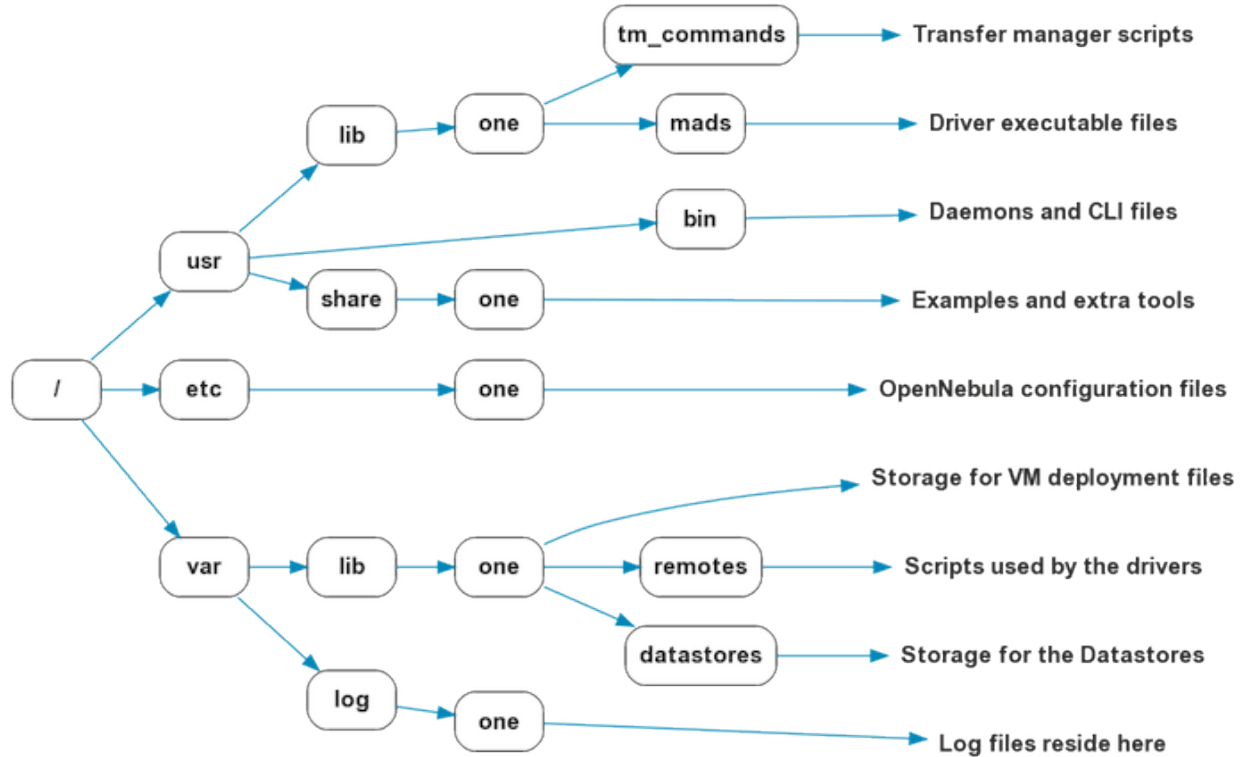

## 1.4.5 Step 5. Node Installation

### 5.1. Installing on CentOS/RHEL

When the front-end is installed and verified, it is time to install the packages for the nodes if you are using KVM. To install a CentOS/RHEL OpenNebula front-end with packages from our repository, add the repo using the snippet from the previous section and execute the following as root:

```
# sudo yum install opennebula-node-kvm
```

If you are using Xen you can prepare the node with `opennebula-common`:

```
# sudo yum install opennebula-common
```

For further configuration and/or installation of other hypervisors, check their specific guides: Xen, KVM and VMware.

### 5.2. Installing on Debian/Ubuntu

When the front-end is installed, it is time to install the packages for the nodes if you are using KVM. To install a Debian/Ubuntu OpenNebula front-end with packages from our repository, add the repo as described in the previous section and then install the node package.

```
$ sudo apt-get install opennebula-node
```

For further configuration and/or installation of other hypervisors, check their specific guides: Xen, KVM and VMware.

## 1.4.6 Step 6. Manual Configuration of Unix Accounts

**Warning:** This step can be skipped if you have installed the node/common package for CentOS or Ubuntu, as it has already been taken care of.

The OpenNebula package installation creates a new user and group named `oneadmin` in the front-end. This account will be used to run the OpenNebula services and to do regular administration and maintenance tasks. That means that you eventually need to login as that user or to use the `sudo -u oneadmin` method.

The hosts need also this user created and configured. Make sure you change the `uid` and `gid` by the ones you have in the front-end.

- Get the user and group id of `oneadmin`. This id will be used later to create users in the hosts with the same id. In the **front-end**, execute as `oneadmin`:

```
$ id oneadmin
uid=1001(oneadmin) gid=1001(oneadmin) groups=1001(oneadmin)
```

In this case the user id will be 1001 and group also 1001.

Then log as root **in your hosts** and follow these steps:

- Create the `oneadmin` group. Make sure that its id is the same as in the frontend. In this example 1001:

```
# groupadd --gid 1001 oneadmin
```

- Create the `oneadmin` account, we will use the OpenNebula `var` directory as the home directory for this user.

```
# useradd --uid 1001 -g oneadmin -d /var/lib/one oneadmin
```

**Warning:** You can use any other method to make a common `oneadmin` group and account in the nodes, for example NIS.

## 1.4.7 Step 7. Manual Configuration of Secure Shell Access

You need to create `ssh` keys for the `oneadmin` user and configure the host machines so it can connect to them using `ssh` without need for a password.

Follow these steps in the **front-end**:

- Generate `oneadmin` `ssh` keys:

```
$ ssh-keygen
```

When prompted for password press enter so the private key is not encrypted.

- Append the public key to `~/.ssh/authorized_keys` to let `oneadmin` user log without the need to type a password.

```
$ cat ~/.ssh/id_rsa.pub >> ~/.ssh/authorized_keys
```

- Many distributions (RHEL/CentOS for example) have permission requirements for the public key authentication to work:

```
$ chmod 700 ~/.ssh/  
$ chmod 600 ~/.ssh/id_dsa.pub  
$ chmod 600 ~/.ssh/id_dsa  
$ chmod 600 ~/.ssh/authorized_keys
```

- Tell ssh client to not ask before adding hosts to `known_hosts` file. Also it is a good idea to reduced the connection timeout in case of network problems. This is configured into `~/.ssh/config`, see `man ssh_config` for a complete reference.:

```
$ cat ~/.ssh/config  
ConnectTimeout 5  
Host *  
    StrictHostKeyChecking no
```

- Check that the `sshd` daemon is running in the hosts. Also remove any `Banner` option from the `sshd_config` file in the hosts.
- Finally, Copy the front-end `/var/lib/one/.ssh` directory to each one of the hosts in the same path.

To test your configuration just verify that `oneadmin` can log in the hosts without being prompt for a password.

### 1.4.8 Step 8. Networking Configuration

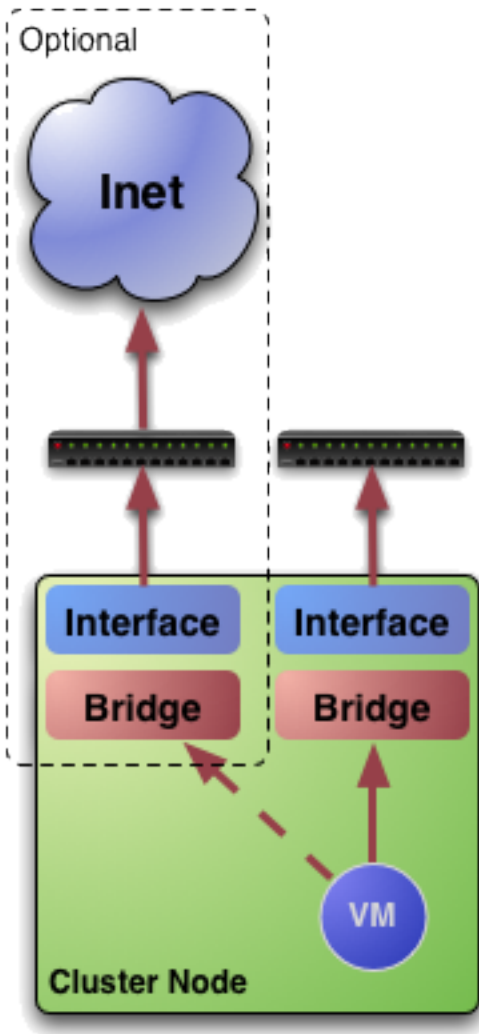

A network connection is needed by the OpenNebula front-end daemons to access the hosts to manage and monitor the hypervisors; and move image files. It is highly recommended to install a dedicated network for this purpose.

There are various network models (please check the Networking guide to find out the networking technologies supported by OpenNebula), but they all have something in common. They rely on network bridges with the same name in all the hosts to connect Virtual Machines to the physical network interfaces.

The simplest network model corresponds to the dummy drivers, where only the network bridges are needed.

For example, a typical host with two physical networks, one for public IP addresses (attached to eth0 NIC) and the other for private virtual LANs (NIC eth1) should have two bridges:

```
$ brctl show
bridge name bridge id          STP enabled interfaces
br0         8000.001e682f02ac no         eth0
br1         8000.001e682f02ad no         eth1
```

## 1.4.9 Step 9. Storage Configuration

OpenNebula uses Datastores to manage VM disk Images. There are two configuration steps needed to perform a basic set up:

- First, you need to configure the **system datastore** to hold images for the running VMs, check the the System Datastore Guide, for more details.
- Then you have to setup one ore more datastore for the disk images of the VMs, you can find more information on setting up Filesystem Datastores here.

The suggested configuration is to use a shared FS, which enables most of OpenNebula VM controlling features. OpenNebula **can work without a Shared FS**, but this will force the deployment to always clone the images and you will only be able to do *cold* migrations.

The simplest way to achieve a shared FS backend for OpenNebula datastores is to export via NFS from the OpenNebula front-end both the `system (/var/lib/one/datastores/0)` and the `images (/var/lib/one/datastores/1)` datastores. They need to be mounted by all the virtualization nodes to be added into the OpenNebula cloud.

## 1.4.10 Step 10. Adding a Node to the OpenNebula Cloud

To add a node to the cloud, there are four needed parameters: name/IP of the host, virtualization, network and information driver. Using the recommended configuration above, and assuming a KVM hypervisor, you can add your host `node01` to OpenNebula in the following fashion (as `oneadmin`, in the front-end):

```
$ onehost create node01 -i kvm -v kvm -n dummy
```

To learn more about the host subsystem, read this guide.

## 1.4.11 Step 11. Next steps

Now that you have a fully functional cloud, it is time to start learning how to use it. A good starting point is this overview of the virtual resource management.

# 1.5 Glossary

## 1.5.1 OpenNebula Components

- **Front-end:** Machine running the OpenNebula services.
- **Host:** Physical machine running a supported hypervisor. See the Host subsystem.
- **Cluster:** Pool of hosts that share datastores and virtual networks. Clusters are used for load balancing, high availability, and high performance computing.
- **Image Repository:** Storage for registered Images. Learn more about the Storage subsystem.
- **Sunstone:** OpenNebula web interface. Learn more about Sunstone
- **OCCI Service:** Server that enables the management of OpenNebula with OCCI interface. You can use [rOCCI server](#) to provide this service.
- **Self-Service** OpenNebula web interfaced towards the end user. It is implemented by configuring a user view of the Sunstone Portal.

- **EC2 Service:** Server that enables the management of OpenNebula with EC2 interface. Learn more about EC2 Service
- **OCA:** OpenNebula Cloud API. It is a set of libraries that ease the communication with the XML-RPC management interface. Learn more about ruby and java APIs.

## 1.5.2 OpenNebula Resources

- **Template:** Virtual Machine definition. These definitions are managed with the onetemplate command.
- **Image:** Virtual Machine disk image, created and managed with the oneimage command.
- **Virtual Machine:** Instantiated Template. A Virtual Machine represents one life-cycle, and several Virtual Machines can be created from a single Template. Check out the VM management guide.
- **Virtual Network:** A group of IP leases that VMs can use to automatically obtain IP addresses. See the Networking subsystem.
- **VDC:** Virtual Data Center, fully-isolated virtual infrastructure environments where a group of users, under the control of the VDC administrator.
- **Zone:** A group of interconnected physical hosts with hypervisors controlled by OpenNebula.

## 1.5.3 OpenNebula Management

- **ACL:** Access Control List. Check the managing ACL rules guide.
- **oneadmin:** Special administrative account. See the Users and Groups guide.
- **Federation:** Several OpenNebula instances can be configured as zones.



## QUICK STARTS

### 2.1 Quickstart: OpenNebula on CentOS 7 and KVM

The purpose of this guide is to provide users with step by step guide to install OpenNebula using CentOS 7 as the operating system and KVM as the hypervisor.

After following this guide, users will have a working OpenNebula with graphical interface (Sunstone), at least one hypervisor (host) and a running virtual machines. This is useful at the time of setting up pilot clouds, to quickly test new features and as base deployment to build a large infrastructure.

Throughout the installation there are two separate roles: **Frontend** and **Nodes**. The Frontend server will execute the OpenNebula services, and the Nodes will be used to execute virtual machines. Please not that **it is possible** to follow this guide with just one host combining both the Frontend and Nodes roles in a single server. However it is recommended execute virtual machines in hosts with virtualization extensions. To test if your host supports virtualization extensions, please run:

```
grep -E 'svm|vmx' /proc/cpuinfo
```

If you don't get any output you probably don't have virtualization extensions supported/enabled in your server.

#### 2.1.1 Package Layout

- `opennebula-server`: OpenNebula Daemons
- `opennebula`: OpenNebula CLI commands
- `opennebula-sunstone`: OpenNebula's web GUI
- `opennebula-java`: OpenNebula Java API
- `opennebula-node-kvm`: Installs dependencies required by OpenNebula in the nodes
- `opennebula-gate`: Send information from Virtual Machines to OpenNebula
- `opennebula-flow`: Manage OpenNebula Services
- `opennebula-context`: Package for OpenNebula Guests

Additionally `opennebula-common` and `opennebula-ruby` exist but they're intended to be used as dependencies.

**Warning:** In order to avoid problems, we recommend to disable SELinux in all the nodes, **Frontend** and **Nodes**.

```
# vi /etc/sysconfig/selinux
...
SELINUX=disabled
...

# setenforce 0
# getenforce
Permissive
```

**Warning:** Some commands may fail depending on your iptables/firewalld configuration. Disable the firewalls entirely for testing just to rule it out.

## 2.1.2 Step 1. Installation in the Frontend

---

**Note:** Commands prefixed by # are meant to be run as `root`. Commands prefixed by \$ must be run as `oneadmin`.

---

### 1.1. Install the repo

Enable the EPEL repo:

```
# yum install epel-release
```

Add the OpenNebula repository:

```
# cat << EOT > /etc/yum.repos.d/opennebula.repo
[opennebula]
name=opennebula
baseurl=http://downloads.opennebula.org/repo/4.14/CentOS/7/x86_64/
enabled=1
gpgcheck=0
EOT
```

### 1.2. Install the required packages

A complete install of OpenNebula will have at least both `opennebula-server` and `opennebula-sunstone` package:

```
# yum install opennebula-server opennebula-sunstone
```

Now run `install_gems` to install all the gem dependencies. Choose the *CentOS/RedHat* if prompted:

```
# /usr/share/one/install_gems
lsb_release command not found. If you are using a RedHat based
distribution install redhat-lsb

Select your distribution or press enter to continue without
installing dependencies.

0. Ubuntu/Debian
1. CentOS/RedHat
```

### 1.3. Configure and Start the services

There are two main processes that must be started, the main OpenNebula daemon: `oned`, and the graphical user interface: `sunstone`.

Sunstone listens only in the loopback interface by default for security reasons. To change it edit `/etc/one/sunstone-server.conf` and change `:host: 127.0.0.1` to `:host: 0.0.0.0`.

Now we can start the services:

```
# systemctl enable opennebula
# systemctl start opennebula
# systemctl enable opennebula-sunstone
# systemctl start opennebula-sunstone
```

### 1.4. Configure NFS

**Note:** Skip this section if you are using a single server for both the frontend and worker node roles.

Export `/var/lib/one/` from the frontend to the worker nodes. To do so add the following to the `/etc/exports` file in the frontend:

```
/var/lib/one/ *(rw, sync, no_subtree_check, root_squash)
```

Refresh the NFS exports by doing:

```
# systemctl restart nfs.service
```

### 1.5. Configure SSH Public Key

OpenNebula will need to SSH passwordlessly from any node (including the frontend) to any other node.

Add the following snippet to `~/.ssh/config` as `oneadmin` so it doesn't prompt to add the keys to the `known_hosts` file:

```
# su - oneadmin
$ cat << EOT > ~/.ssh/config
Host *
    StrictHostKeyChecking no
    UserKnownHostsFile /dev/null
EOT
$ chmod 600 ~/.ssh/config
```

## 2.1.3 Step 2. Installation in the Nodes

### 2.1. Install the repo

Add the OpenNebula repository:

```
# cat << EOT > /etc/yum.repos.d/opennebula.repo
[opennebula]
name=opennebula
baseurl=http://downloads.opennebula.org/repo/4.14/CentOS/7/x86_64/
enabled=1
```

```
gpgcheck=0
EOT
```

## 2.2. Install the required packages

```
# yum install opennebula-node-kvm
```

Start the required services:

```
# systemctl enable messagebus.service
# systemctl start messagebus.service
# systemctl enable libvirtd.service
# systemctl start libvirtd.service
# systemctl enable nfs.service
# systemctl start nfs.service
```

## 2.3. Configure the Network

**Warning:** Backup all the files that are modified in this section before making changes to them.

You will need to have your main interface connected to a bridge. We will do the following example with `ens3` but the name of the interface may vary. An OpenNebula requirements is that the name of the bridge should be the same in all nodes.

To do so, substitute `/etc/sysconfig/network-scripts/ifcfg-ens3` with:

```
DEVICE=ens3
BOOTPROTO=none
NM_CONTROLLED=no
ONBOOT=yes
TYPE=Ethernet
BRIDGE=br0
```

And add a new `/etc/sysconfig/network-scripts/ifcfg-br0` file.

If you were using DHCP for your `ens3` interface, use this template:

```
DEVICE=br0
TYPE=Bridge
ONBOOT=yes
BOOTPROTO=dhcp
NM_CONTROLLED=no
```

If you were using a static IP address use this other template:

```
DEVICE=br0
TYPE=Bridge
IPADDR=<YOUR_IPADDRESS>
NETMASK=<YOUR_NETMASK>
ONBOOT=yes
BOOTPROTO=static
NM_CONTROLLED=no
```

After these changes, restart the network:

```
# systemctl restart network.service
```

## 2.4. Configure NFS

**Note:** Skip this section if you are using a single server for both the frontend and worker node roles.

Mount the datastores export. Add the following to your `/etc/fstab`:

```
192.168.1.1:/var/lib/one/ /var/lib/one/ nfs soft,intr,rsize=8192,wsiz=8192,noauto
```

**Note:** Replace `192.168.1.1` with the IP of the frontend.

Mount the NFS share:

```
# mount /var/lib/one/
```

If the above command fails or hangs, it could be a firewall issue.

### 2.1.4 Step 3. Basic Usage

**Note:** All the operations in this section can be done using Sunstone instead of the command line. Point your browser to: `http://frontend:9869`.

The default password for the `oneadmin` user can be found in `~/ .one/one_auth` which is randomly generated on every installation.

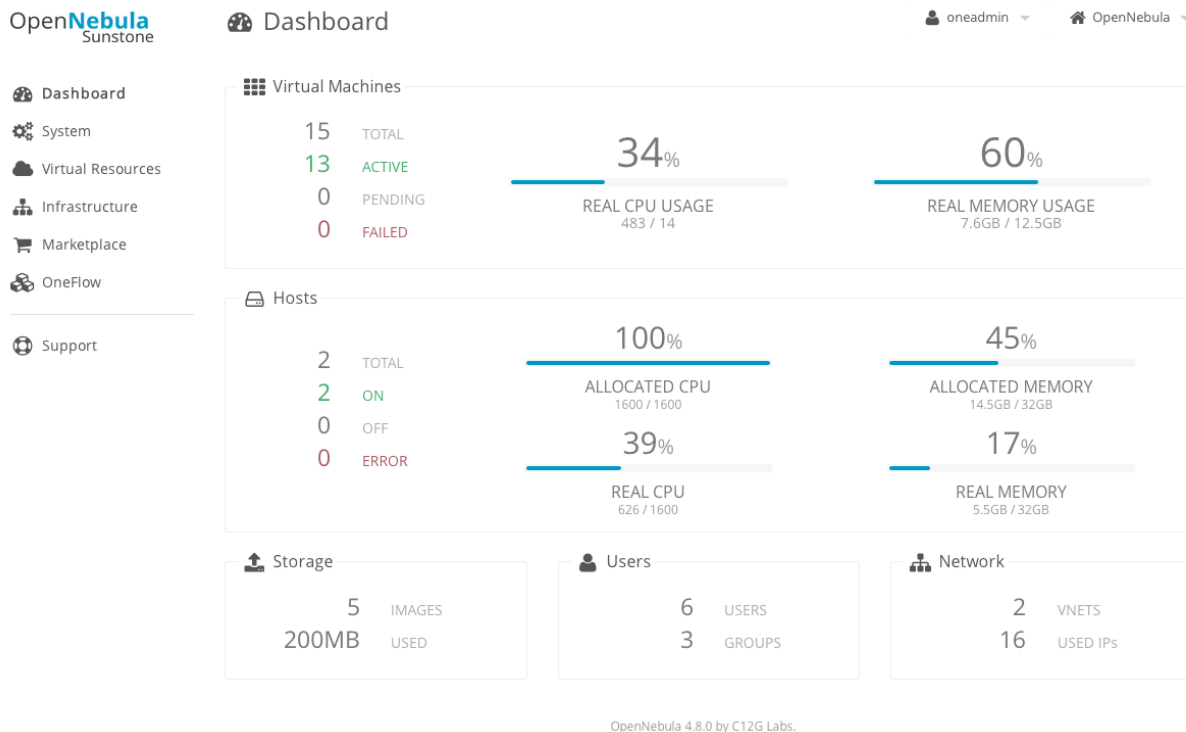

To interact with OpenNebula, you have to do it from the `oneadmin` account in the frontend. We will assume all the following commands are performed from that account. To login as `oneadmin` execute `su - oneadmin`.

### 3.1. Adding a Host

To start running VMs, you should first register a worker node for OpenNebula.

Issue this command for each one of your nodes. Replace `localhost` with your node's hostname.

```
$ onehost create localhost -i kvm -v kvm -n dummy
```

Run `onehost list` until it's set to on. If it fails you probably have something wrong in your ssh configuration. Take a look at `/var/log/one/oned.log`.

### 3.2. Adding virtual resources

Once it's working you need to create a network, an image and a virtual machine template.

To create networks, we need to create first a network template file `mynetwork.one` that contains:

```
NAME = "private"

BRIDGE = br0

AR = [
    TYPE = IP4,
    IP = 192.168.0.100,
    SIZE = 3
]
```

---

**Note:** Replace the address range with free IPs in your host's network. You can add more than one address range.

---

Now we can move ahead and create the resources in OpenNebula:

```
$ onevnet create mynetwork.one

$ oneimage create --name "CentOS-7-one-4.8" \
  --path http://marketplace.c12g.com/appliance/53e7bf928fb81d6a69000002/download \
  --driver qcow2 \
  -d default

$ onetemplate create --name "CentOS-7" \
  --cpu 1 --vcpu 1 --memory 512 --arch x86_64 \
  --disk "CentOS-7-one-4.8" \
  --nic "private" \
  --vnc --ssh --net_context
```

---

**Note:** If `oneimage create` complains because there's not enough space available in the datastore, you can disable the datastore capacity check in OpenNebula: `/etc/one/oned.conf:DATASTORE_CAPACITY_CHECK = "no"`. You need to restart OpenNebula after changing this.

---

You will need to wait until the image is ready to be used. Monitor its state by running `oneimage list`.

In order to dynamically add ssh keys to Virtual Machines we must add our ssh key to the user template, by editing the user template:

```
$ EDITOR=vi oneuser update oneadmin
```

Add a new line like the following to the template:

```
SSH_PUBLIC_KEY="ssh-dss AAAAB3NzaC1kc3MAAACBANBWTQmm4Gt..."
```

Substitute the value above with the output of `cat ~/.ssh/id_dsa.pub`.

### 3.3. Running a Virtual Machine

To run a Virtual Machine, you will need to instantiate a template:

```
$ onetemplate instantiate "CentOS-7"
```

Execute `onevm list` and watch the virtual machine going from PENDING to PROLOG to RUNNING. If the vm fails, check the reason in the log: `/var/log/one/<VM_ID>/vm.log`.

**Note:** If it stays too long in pend status you can check why by doing: `onevm show <vmid>|grep ^SCHED_MESSAGE`. If it reports that no datastores have enough capacity for the VM, you can force a manual deployment by running: `onevm deploy <vmid> <hostid>`.

## 2.1.5 Further information

- [Planning the Installation](#)
- [Installing the Software](#)
- [FAQs](#). Good for troubleshooting
- [Main Documentation](#)

## 2.2 Quickstart: OpenNebula on Ubuntu 14.04 and KVM

The purpose of this guide is to provide users with step by step guide to install OpenNebula using Ubuntu 14.04 as the operating system and KVM as the hypervisor.

After following this guide, users will have a working OpenNebula with graphical interface (Sunstone), at least one hypervisor (host) and a running virtual machines. This is useful at the time of setting up pilot clouds, to quickly test new features and as base deployment to build a large infrastructure.

Throughout the installation there are two separate roles: **Frontend** and **Nodes**. The Frontend server will execute the OpenNebula services, and the Nodes will be used to execute virtual machines. Please not that **it is possible** to follow this guide with just one host combining both the Frontend and Nodes roles in a single server. However it is recommended execute virtual machines in hosts with virtualization extensions. To test if your host supports virtualization extensions, please run:

```
grep -E 'svm|vmx' /proc/cpuinfo
```

If you don't get any output you probably don't have virtualization extensions supported/enabled in your server.

### 2.2.1 Package Layout

- **opennebula-common**: Provides the user and common files
- **ruby-opennebula**: All ruby libraries
- **opennebula-node**: Prepares a node as an opennebula-node

- **opennebula-sunstone**: OpenNebula Sunstone Web Interface
- **opennebula-tools**: Command Line interface
- **opennebula-gate**: Gate server that enables communication between VMs and OpenNebula
- **opennebula-flow**: Manages services and elasticity
- **libopennebula-java**: Java Language bindings for OpenNebula API
- **opennebula**: OpenNebula Daemon
- **libopennebula-java**: Java Language bindings for OpenNebula API

### 2.2.2 Step 1. Installation in the Frontend

**Warning:** Commands prefixed by # are meant to be run as `root`. Commands prefixed by \$ must be run as `oneadmin`.

#### 1.1. Install the repo

Add the OpenNebula repository:

```
# wget -q -O- http://downloads.opennebula.org/repo/Ubuntu/repo.key | apt-key add -
# echo "deb http://downloads.opennebula.org/repo/4.14/Ubuntu/14.04/ stable opennebula"
  > /etc/apt/sources.list.d/opennebula.list
```

#### 1.2. Install the required packages

```
# apt-get update
# apt-get install opennebula opennebula-sunstone nfs-kernel-server
```

#### 1.3. Configure and Start the services

There are two main processes that must be started, the main OpenNebula daemon: `oned`, and the graphical user interface: `sunstone`.

`Sunstone` listens only in the loopback interface by default for security reasons. To change it edit `/etc/one/sunstone-server.conf` and change `:host: 127.0.0.1` to `:host: 0.0.0.0`.

Now we must restart `Sunstone`:

```
# /etc/init.d/opennebula-sunstone restart
```

#### 1.4. Configure NFS

**Warning:** Skip this section if you are using a single server for both the frontend and worker node roles.

Export `/var/lib/one/` from the frontend to the worker nodes. To do so add the following to the `/etc/exports` file in the frontend:



```
/var/lib/one/ *(rw, sync, no_subtree_check, root_squash)
```

Refresh the NFS exports by doing:

```
# service nfs-kernel-server restart
```

## 1.5. Configure SSH Public Key

OpenNebula will need to SSH passwordlessly from any node (including the frontend) to any other node.

To do so run the following commands:

```
# su - oneadmin
$ cp ~/.ssh/id_rsa.pub ~/.ssh/authorized_keys
```

Add the following snippet to `~/.ssh/config` so it doesn't prompt to add the keys to the `known_hosts` file:

```
$ cat << EOT > ~/.ssh/config
Host *
    StrictHostKeyChecking no
    UserKnownHostsFile /dev/null
EOT
$ chmod 600 ~/.ssh/config
```

## 2.2.3 Step 2. Installation in the Nodes

### 2.1. Install the repo

Add the OpenNebula repository:

```
# wget -q -O- http://downloads.opennebula.org/repo/Ubuntu/repo.key | apt-key add -
# echo "deb http://downloads.opennebula.org/repo/4.14/Ubuntu/14.04/ stable opennebula" > \
  /etc/apt/sources.list.d/opennebula.list
```

### 2.2. Install the required packages

```
# apt-get update
# apt-get install opennebula-node nfs-common bridge-utils
```

### 2.3. Configure the Network

**Warning:** Backup all the files that are modified in this section before making changes to them.

You will need to have your main interface, typically `eth0`, connected to a bridge. The name of the bridge should be the same in all nodes.

If you were using DHCP for your `eth0` interface, replace `/etc/network/interfaces` with:

```
auto lo
iface lo inet loopback

auto br0
```

```
iface br0 inet dhcp
    bridge_ports eth0
    bridge_fd 9
    bridge_hello 2
    bridge_maxage 12
    bridge_stp off
```

If you were using a static IP addresses instead, use this other template:

```
auto lo
iface lo inet loopback

auto br0
iface br0 inet static
    address 192.168.0.10
    network 192.168.0.0
    netmask 255.255.255.0
    broadcast 192.168.0.255
    gateway 192.168.0.1
    bridge_ports eth0
    bridge_fd 9
    bridge_hello 2
    bridge_maxage 12
    bridge_stp off
```

After these changes, restart the network:

```
# /etc/init.d/networking restart
```

## 2.4. Configure NFS

**Warning:** Skip this section if you are using a single server for both the frontend and worker node roles.

Mount the datastores export. Add the following to your `/etc/fstab`:

```
192.168.1.1:/var/lib/one/ /var/lib/one/ nfs soft,intr,rsize=8192,wsiz=8192,noauto
```

**Warning:** Replace `192.168.1.1` with the IP of the frontend.

Mount the NFS share:

```
# mount /var/lib/one/
```

If the above command fails or hangs, it could be a firewall issue.

## 2.5. Configure Qemu

The `oneadmin` user must be able to manage libvirt as root:

```
# cat << EOT > /etc/libvirt/qemu.conf
user = "oneadmin"
group = "oneadmin"
dynamic_ownership = 0
EOT
```

Restart libvirt to capture these changes:

```
# service libvirt-bin restart
```

## 2.2.4 Step 3. Basic Usage

**Warning:** All the operations in this section can be done using Sunstone instead of the command line. Point your browser to: `http://frontend:9869`.

The default password for the `oneadmin` user can be found in `~/ .one/one_auth` which is randomly generated on every installation.

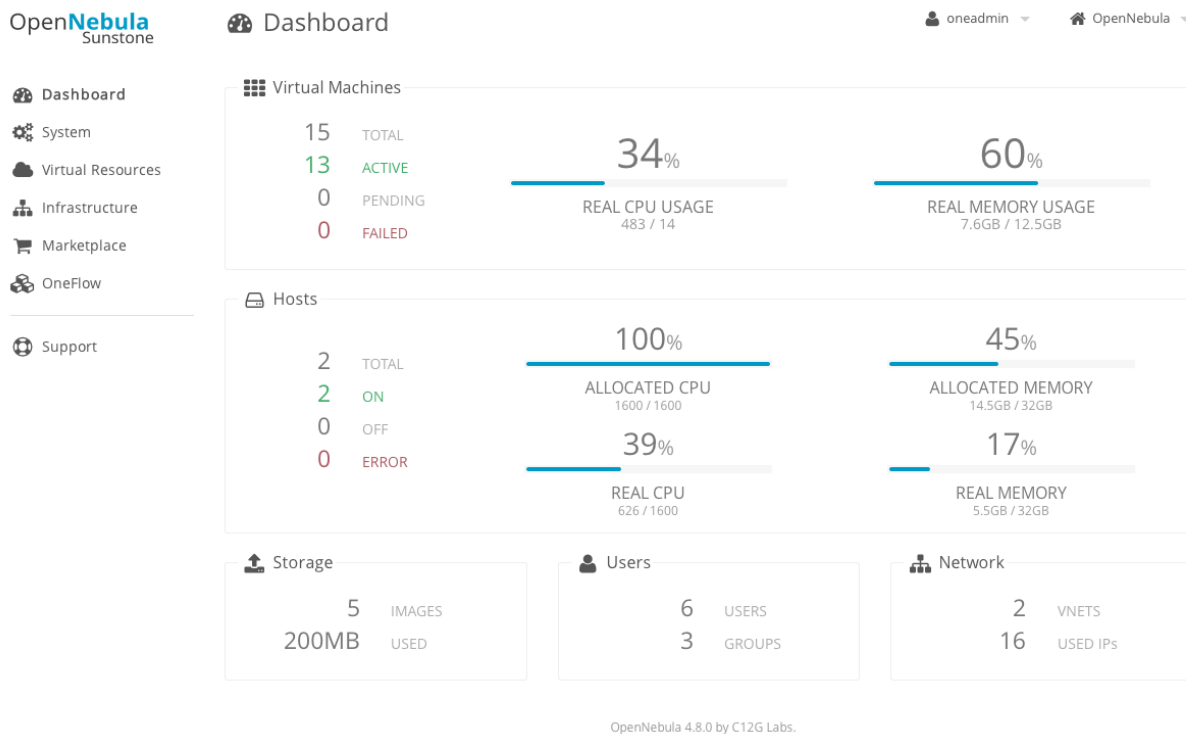

To interact with OpenNebula, you have to do it from the `oneadmin` account in the frontend. We will assume all the following commands are performed from that account. To login as `oneadmin` execute `su - oneadmin`.

### 3.1. Adding a Host

To start running VMs, you should first register a worker node for OpenNebula.

Issue this command for each one of your nodes. Replace `localhost` with your node's hostname.

```
$ onehost create localhost -i kvm -v kvm -n dummy
```

Run `onehost list` until it's set to on. If it fails you probably have something wrong in your ssh configuration. Take a look at `/var/log/one/oned.log`.

### 3.2. Adding virtual resources

Once it's working you need to create a network, an image and a virtual machine template.

To create networks, we need to create first a network template file `mynetwork.one` that contains:

```
NAME = "private"

BRIDGE = br0

AR = [
  TYPE = IP4,
  IP = 192.168.0.100,
  SIZE = 3
]
```

**Warning:** Replace the address range with free IPs in your host's network. You can add more than one address range.

Now we can move ahead and create the resources in OpenNebula:

```
$ onevnet create mynetwork.one

$ oneimage create --name "CentOS-6.5_x86_64" \
  --path "http://appliances.cl2g.com/CentOS-6.5/centos6.5.qcow2.gz" \
  --driver qcow2 \
  --datastore default

$ onetemplate create --name "CentOS-6.5" --cpu 1 --vcpu 1 --memory 512 \
  --arch x86_64 --disk "CentOS-6.5_x86_64" --nic "private" --vnc \
  --ssh
```

You will need to wait until the image is ready to be used. Monitor its state by running `oneimage list`.

In order to dynamically add ssh keys to Virtual Machines we must add our ssh key to the user template, by editing the user template:

```
$ EDITOR=vi oneuser update oneadmin
```

Add a new line like the following to the template:

```
SSH_PUBLIC_KEY="ssh-dss AAAAB3NzaC1kc3MAAACBANBWTQmm4Gt..."
```

Substitute the value above with the output of `cat ~/.ssh/id_dsa.pub`.

### 3.3. Running a Virtual Machine

To run a Virtual Machine, you will need to instantiate a template:

```
$ onetemplate instantiate "CentOS-6.5" --name "My Scratch VM"
```

Execute `onevm list` and watch the virtual machine going from PENDING to PROLOG to RUNNING. If the vm fails, check the reason in the log: `/var/log/one/<VM_ID>/vm.log`.

## 2.2.5 Further information

- [Planning the Installation](#)
- [Installing the Software](#)
- [FAQs. Good for troubleshooting](#)
- [Main Documentation](#)

## 2.3 Quickstart: Create Your First VDC

This guide will provide a quick example of how to partition your cloud for a VDC. In short, a VDC is a group of users with part of the physical resources assigned to them. The *Understanding OpenNebula* guide explains the OpenNebula provisioning model in detail.

### 2.3.1 Create a Cluster

We will first create a cluster, 'web-dev', where we can group hosts, datastores and virtual networks for the new VDC.

```
$ onehost list
ID NAME          CLUSTER  RVM    ALLOCATED_CPU    ALLOCATED_MEM  STAT
0  host01         web-dev   0      0 / 200 (0%)    0K / 7.5G (0%) on
1  host02         web-dev   0      0 / 200 (0%)    0K / 7.5G (0%) on
2  host03         -         0      0 / 200 (0%)    0K / 7.5G (0%) on
3  host04         -         0      0 / 200 (0%)    0K / 7.5G (0%) on

$ onedatastore list
ID NAME          SIZE  AVAIL  CLUSTER  IMAGES  TYPE  DS    TM
0  system         113.3G 25%    web-dev   0  sys  -     shared
1  default        113.3G 25%    web-dev   1  img  fs    shared
2  files          113.3G 25%    -         0  fil  fs    ssh

$ onevnet list
ID USER          GROUP    NAME          CLUSTER  TYPE  BRIDGE  LEASES
0  oneadmin       oneadmin  private       web-dev   R     virbr0  0
```

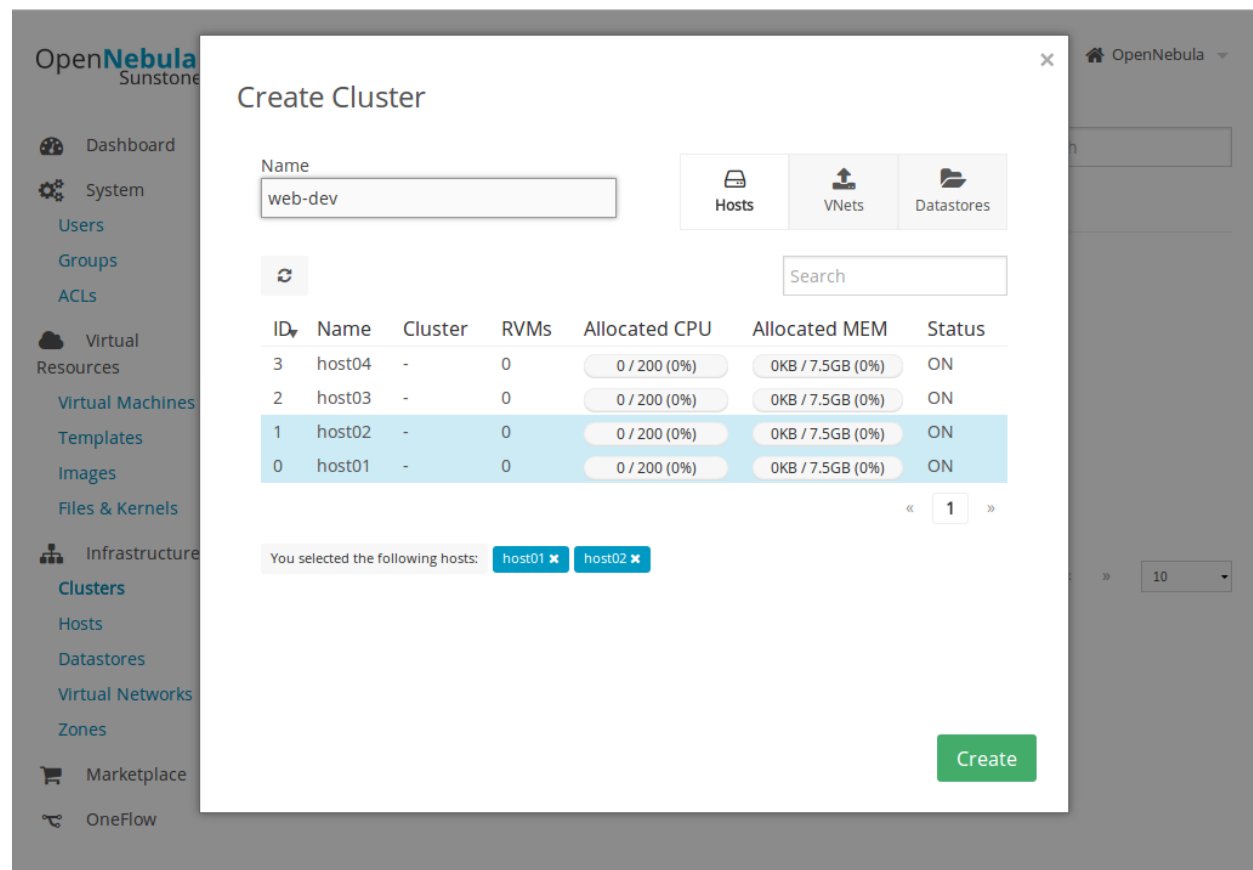

## 2.3.2 Create a Group

We can now create the new group, named also ‘web-dev’. This group will have a special admin user, ‘web-dev-admin’. This admin user will be able to create new users inside the group.

When a new group is created, you will also have the opportunity to configure different options, like the available Sunstone views. Another thing that can be configured is if the virtual resources will be shared for all the users of the group, or private.

```
$ onegroup create --name web-dev --admin_user web-dev-admin --admin_password abcd
ID: 100
```

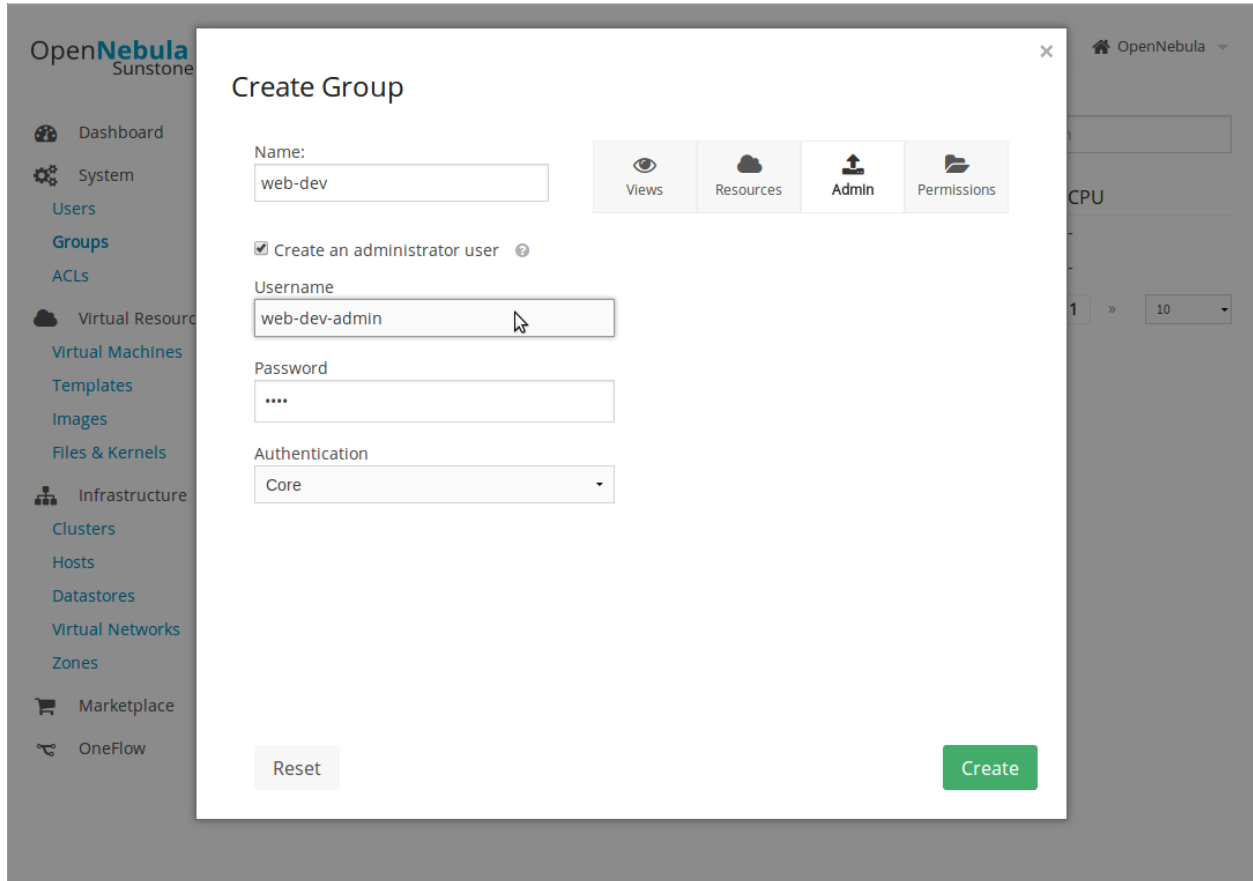

## 2.3.3 Create the VDC

New groups are added to the ‘default’ VDC. If you didn’t modify this VDC, it will allow the users in the new group to access all physical resources. So the first step is to remove this group from its current VDC:

```
$ onevdc delgroup default web-dev
```

The new VDC will be called ‘web-dev’. In the creation wizard, select the group and the cluster created in the previous steps.

```
$ onevdc addgroup 100 web-dev
$ onevdc addcluster 100 0 web-dev
```

## Create Virtual Data Center

- Dashboard
- System
  - Users
  - Groups
  - Virtual Data Centers
  - ACLs
- Virtual Resources
- Infrastructure
- Marketplace
- OneFlow

Support  
Not connected  
[Sign in](#)

[←](#) [Reset](#) [Create](#) [Wizard](#) [Advanced](#)

[General](#) [Groups](#) [Resources](#)

[Refresh](#)

ID	Name	Users	VMs	Memory	CPU
100	web-dev	0	0 / -	0KB / -	0 / -
1	users	0	0 / -	0KB / -	0 / -
0	oneadmin	2	-	-	-

Previous **1** Next

You selected the following groups: [web-dev](#)

OpenNebula 4.10.0 by OpenNebula Systems.

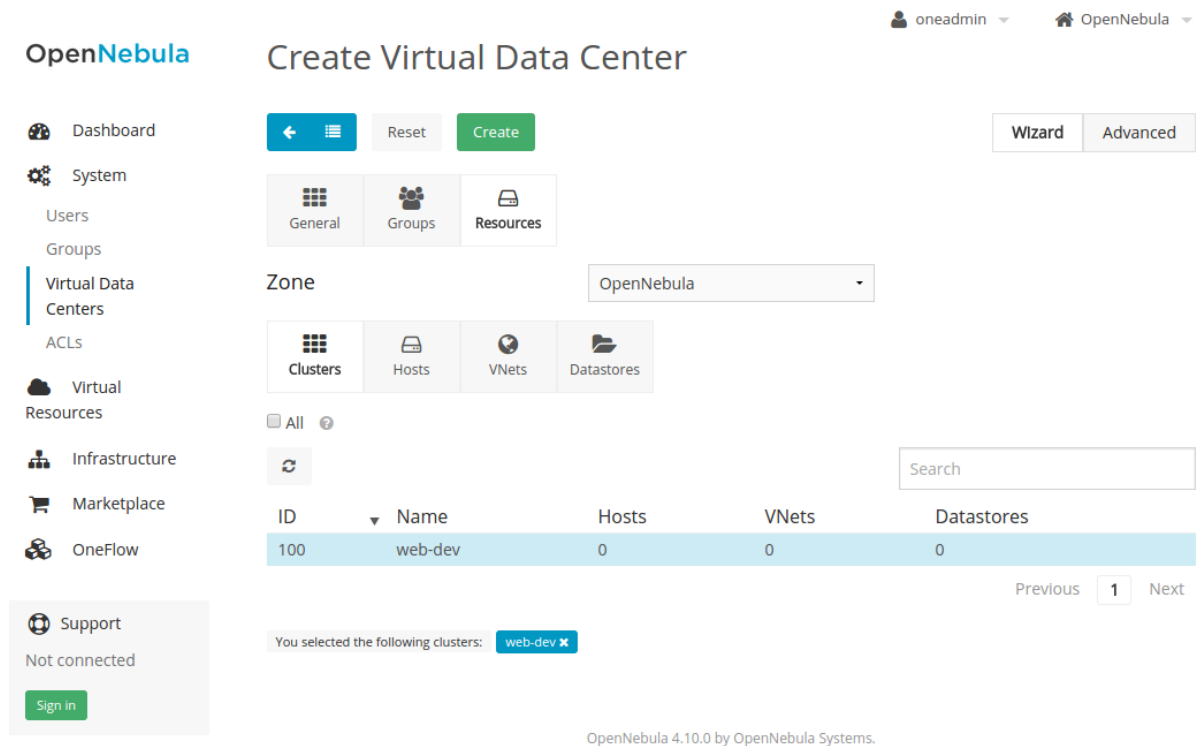

### 2.3.4 Optionally, Set Quotas

The cloud administrator can set usage quotas for the group. In this case, we will put a limit of 10 VMs.

```

$ onegroup show web-dev
GROUP 100 INFORMATION
ID           : 100
NAME        : web-dev

GROUP TEMPLATE
GROUP_ADMINS="web-dev-admin"
GROUP_ADMIN_VIEWS="vdcadmin"
SUNSTONE_VIEWS="cloud"

USERS
ID
2

RESOURCE USAGE & QUOTAS

NUMBER OF VMs          MEMORY          CPU          VOLATILE_SIZE
0 / 10                0M / 0M          0.00 / 0.00  0M / 0M
    
```



The screenshot displays the OpenNebula Sunstone interface for configuring quotas for a Group named '102'. The interface is organized into several sections, each with a table for managing quotas and a '+ Add a new quota' button.

- VMs:** A table with columns 'ID' and 'Running VMs'. The 'Running VMs' column contains the value '10'.
- CPU:** A table with columns 'ID' and 'CPU'. The 'CPU' column contains the value 'Default (∞)'.
- Memory:** A table with columns 'ID' and 'Memory'. The 'Memory' column contains the value 'Default (∞) MB'.
- Volatile disks:** A table with columns 'ID' and 'Volatile disks'. The 'Volatile disks' column contains the value 'Default (∞) MB'.
- Image:** A table with columns 'ID' and 'Running VMs'. It is currently empty.
- Network:** A table with columns 'ID' and 'Leases'. It is currently empty.
- Datastore:** A table with columns 'ID', 'Images', and 'Size'. It is currently empty.

The interface also features a sidebar on the left with navigation options: Dashboard, System (Users, Groups, ACLs), Virtual Resources (Infrastructure, Marketplace, OneFlow), and Support. At the top right, there are buttons for 'Update', 'Quotas', and a trash icon, along with 'Cancel' and 'Apply' buttons.

### 2.3.5 Prepare Virtual Resources for the Users

The cloud administrator has to create the Virtual Machine Templates and Images that the users will instantiate. If you don't have any working Image yet, import the ttylinux testing appliance from the marketplace.

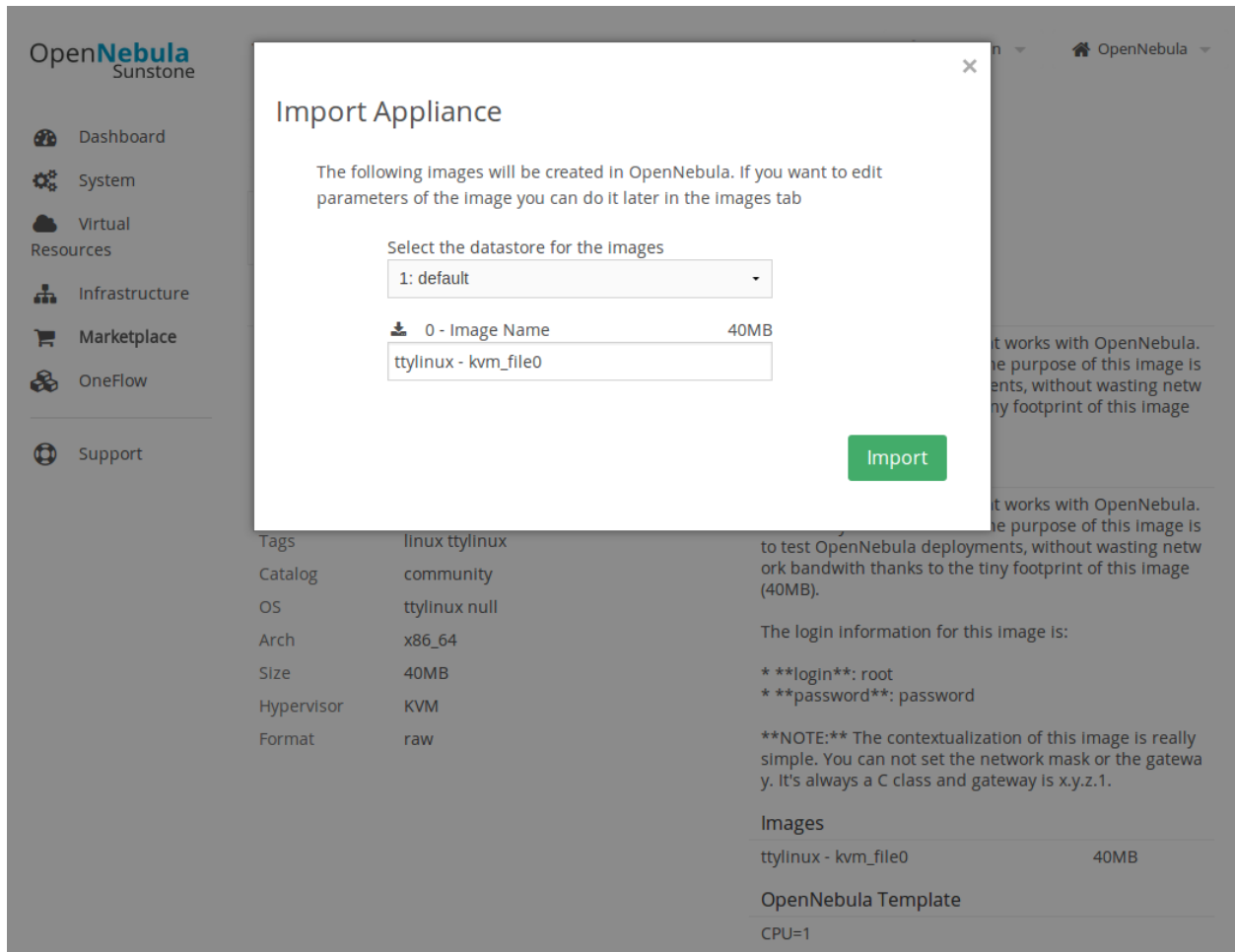

Now you need to create a VM Template that uses the new Image. Make sure you set the features mentioned in the Cloud View guide, specifically the logo, description, ssh key, and user inputs.

The new Template will be owned by oneadmin. To make it available to all users (including the ones of the new group), check the OTHER USE permission **for both the Template and the Image**. Read more about assigning virtual resources to a group in the Managing Groups & VDC guide.

OpenNebula Sunstone

Template 3

oneadmin OpenNebula

Dashboard System Users Groups ACLs Virtual Resources Virtual Machines **Templates** Images Files & Kernels Infrastructure Marketplace OneFlow Support

Update Instantiate Clone

Info Template

Information		Permissions:	Use	Manage	Admin
ID	3	Owner	<input checked="" type="checkbox"/>	<input checked="" type="checkbox"/>	<input type="checkbox"/>
Name	Ubuntu 14.04 - KVM	Group	<input type="checkbox"/>	<input type="checkbox"/>	<input type="checkbox"/>
Register time	18:01:52 05/08/2014	Other	<input checked="" type="checkbox"/>	<input type="checkbox"/>	<input type="checkbox"/>
Ownership		Owner	oneadmin		<input type="checkbox"/>
		Group	oneadmin		<input type="checkbox"/>

OpenNebula 4.8.0 by C12G Labs.

You can also prepare a Service Template. A Service is a group of interconnected Virtual Machines with deployment dependencies between them.

Create a basic Service with two roles: master (x1) and slave (x2). Check 'master' as the parent role of 'slave'. For testing purposes, both can use the ttylinux VM Template. This Service Template also needs to be shared with other users, changing the OTHER USE permission.

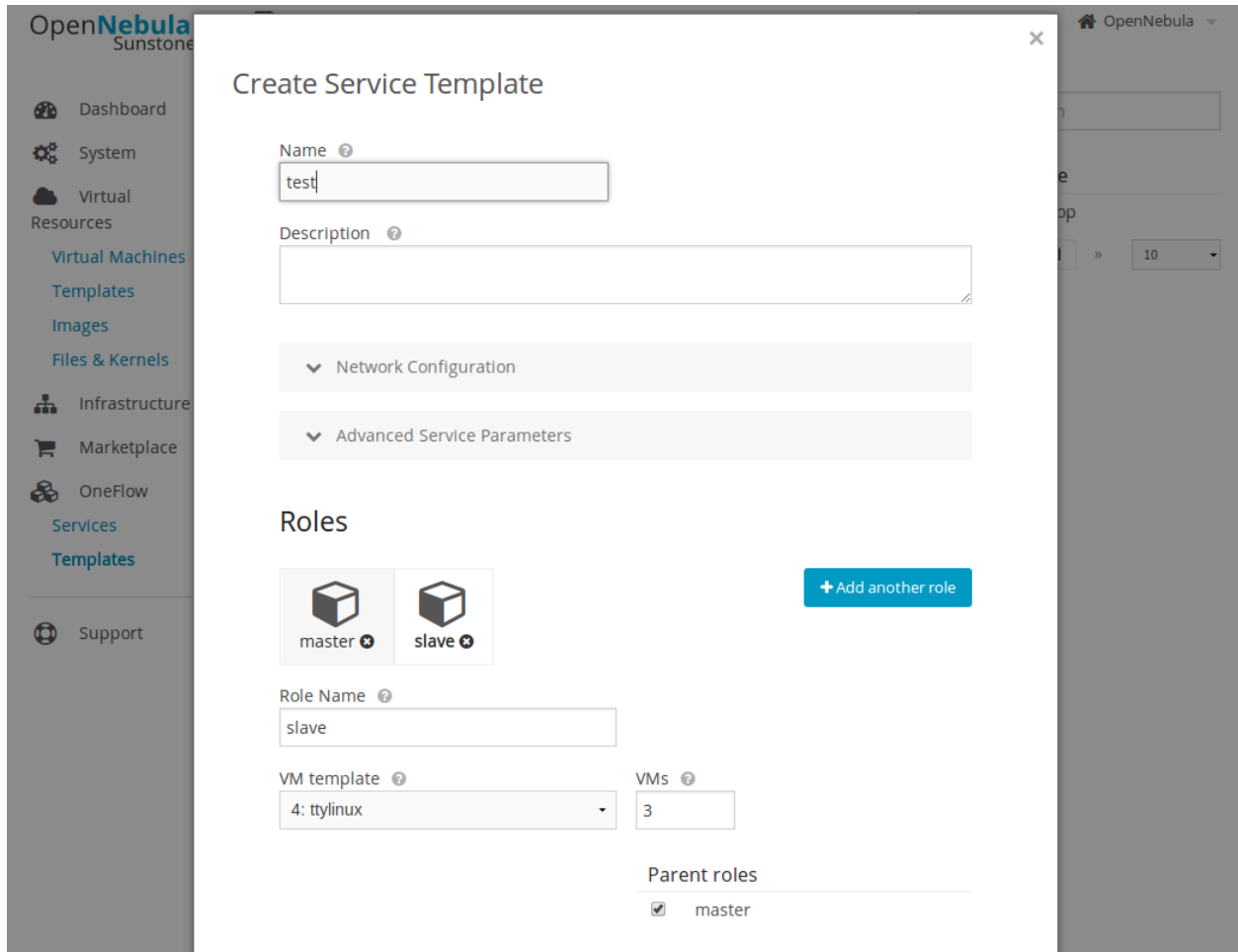

### 2.3.6 Using the Cloud as a Group Admin

If you login as the 'web-dev-admin', you will see a simplified interface, the Group admin view. This view hides the physical infrastructure, but allows some administration tasks to be performed.

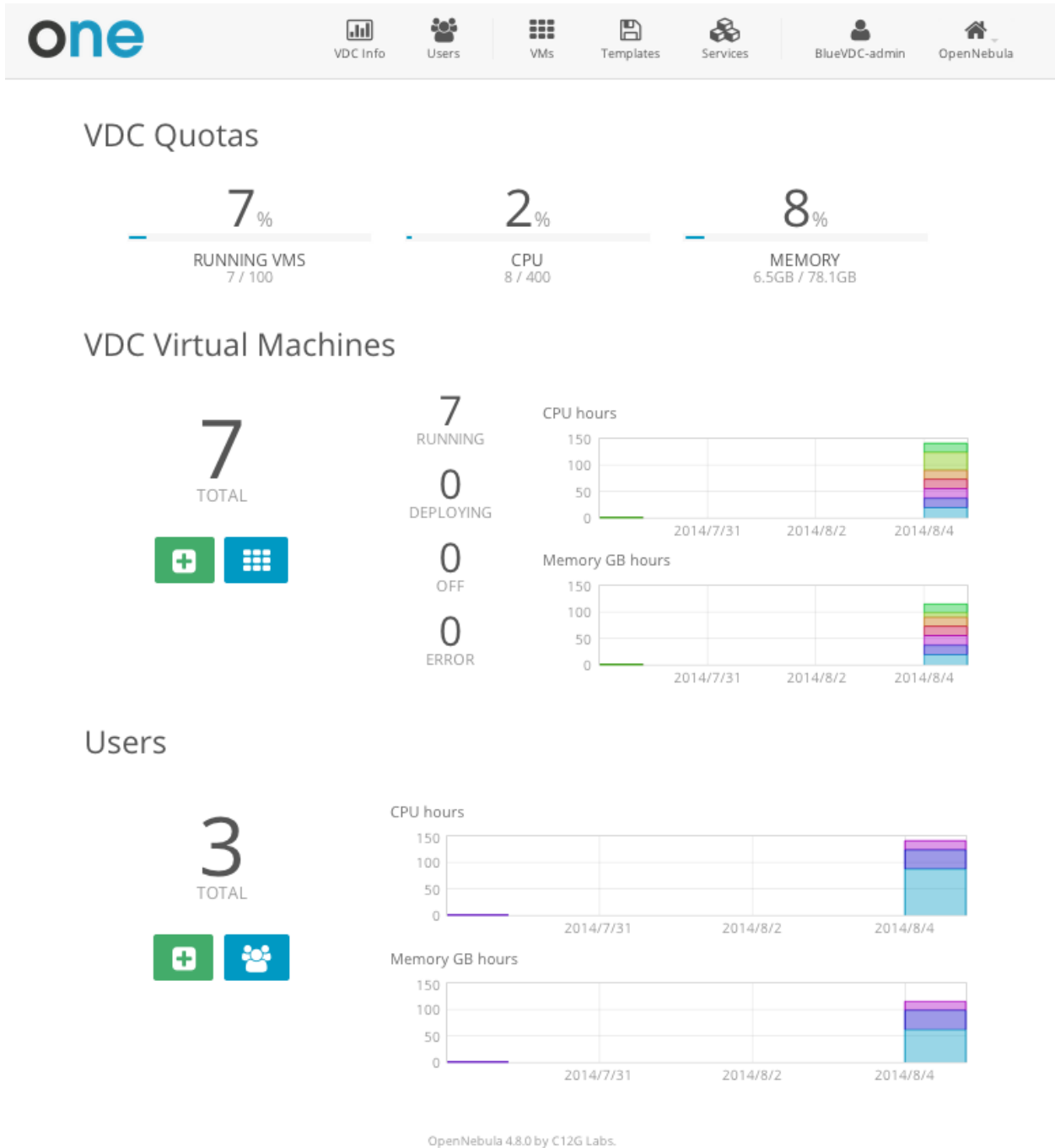

The group admin can create new user accounts, that will belong to the same group. They can also see the current resource usage of all the group users, and set quota limits for each one of them.

The screenshot shows the OpenNebula web interface. At the top, there is a navigation bar with the 'one' logo and several icons: VDC Info, Users, VMs, Templates, Services, BlueVDC-admin, and OpenNebula. Below the navigation bar, the main content area is titled 'Create User'. It contains three input fields: the first contains the text 'John', the second and third contain masked characters (dots). Below this, the 'Define Quotas' section is visible. It has three rows, each with a slider and a text input field: 'Running VMs' with a slider at 10 and an input field containing '10'; 'CPU' with a slider at 20 and an input field containing '20'; and 'Memory (GBs)' with a slider at 60 and an input field containing '60'. At the bottom of this section is a large blue button labeled 'Add User'. Below the button, there is a small footer text: 'OpenNebula 4.8.0 by C12G Labs.'

The group admin can manage the Services, VMs and Templates of other users in the group. The resources of a specific user can be filtered in the list views for each resource type or can be listed in the detailed view of the user.

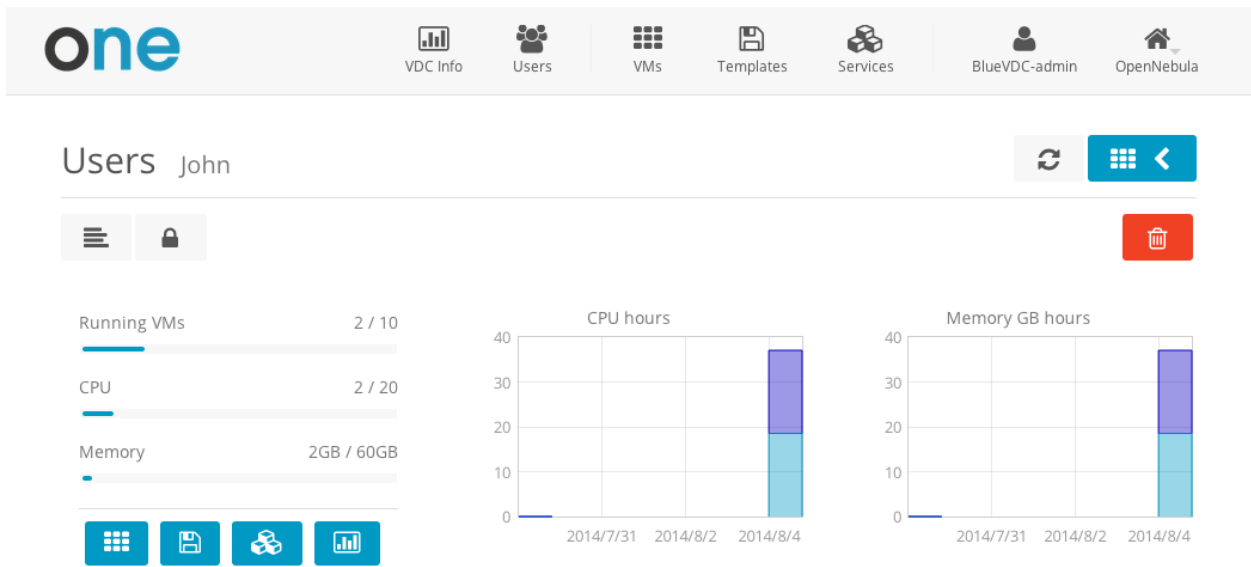

Although the cloud administrator is the only one that can create new base Images and Templates, the group admin can customize existing Templates, and share them with the rest of the group users.

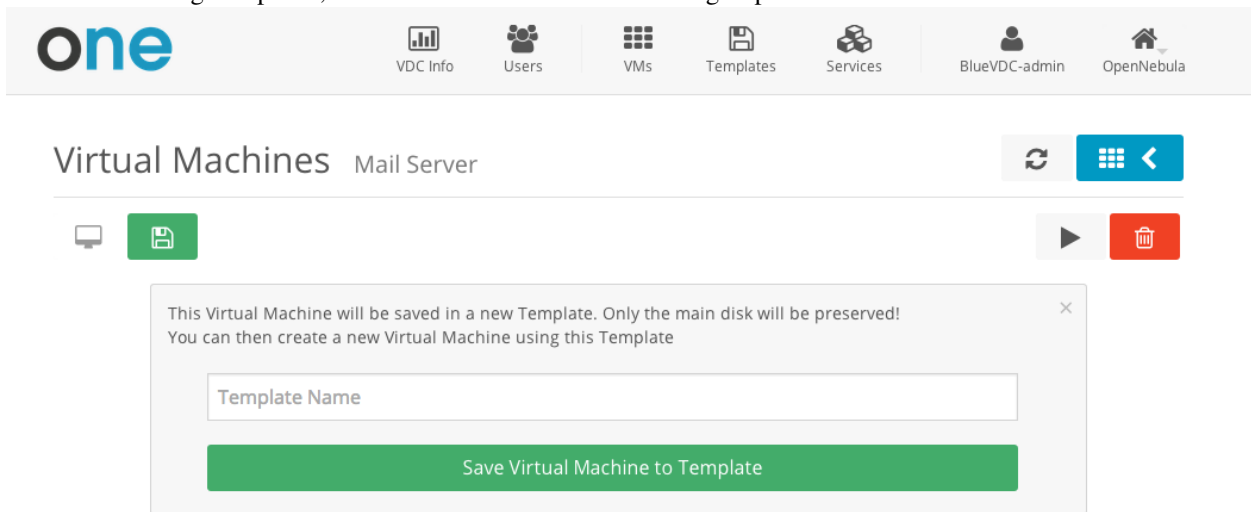

Create a new user, and login again.





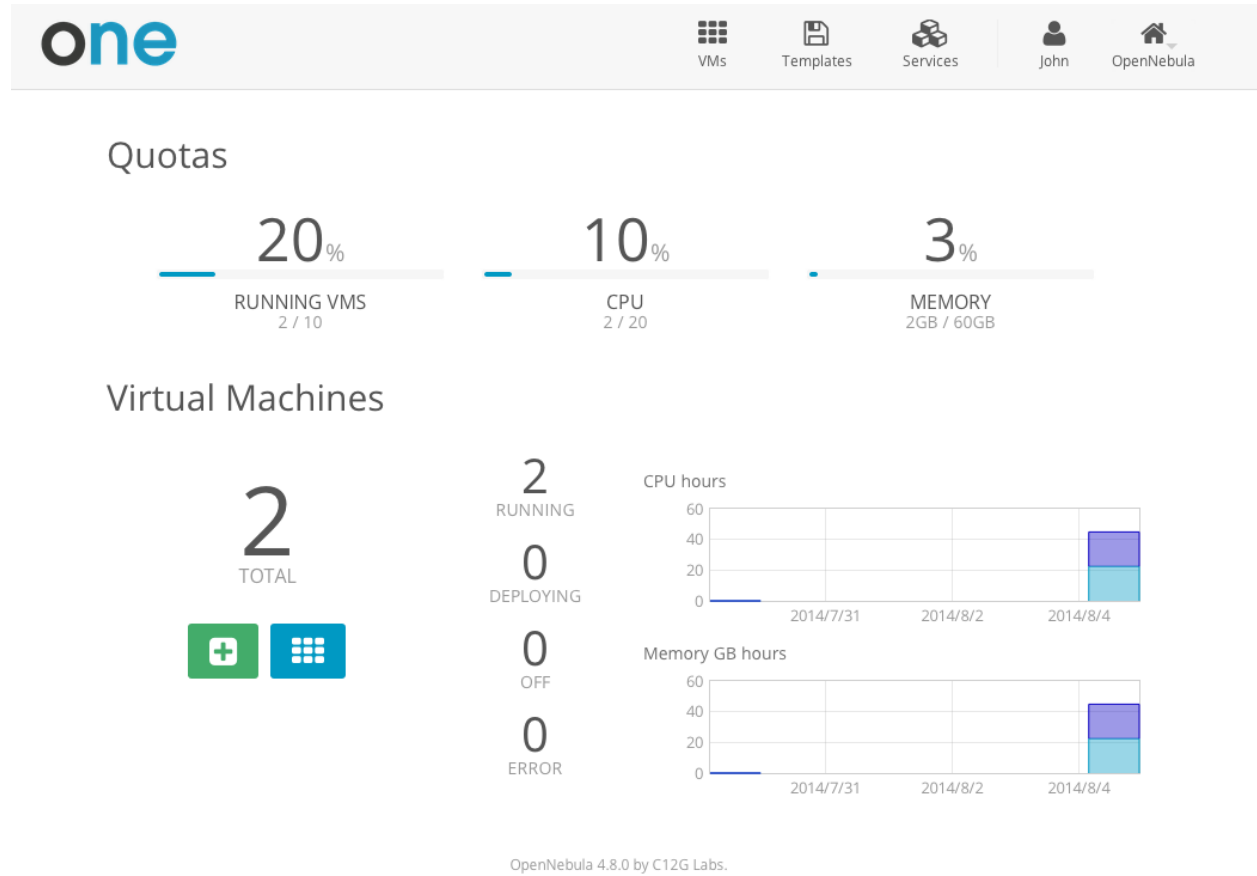

### 2.3.7 Using the Cloud as a Regular User

The regular users access the Cloud View, an even more simplified view of their virtual resources.





The end users can provision new VMs and Services from the templates prepared by the administrators.



 VMs
 Templates
 Services
 John
 OpenNebula







## Create Virtual Machine

## Select a Template

System	VDC	Saved
<input type="text" value="Search"/>		
<p>CentOS 6.6</p>  <p>Vanilla CentOS Server 6.6</p>	<p>Ubuntu 14.04</p>  <p>Ubuntu 14.04.1 (Trusty Tahr)</p>	<p>Fedora 20</p>  <p>Fedora 20 Desktop Edition</p>
« 1 » 6 ▾		

**Create**

They can also manage their own VMs and Services: see their monitorization, shutdown them, and save the changes made.

 VMs
 Templates
 Services
 John
 OpenNebula

## Services Hadoop

  



■ RUNNING

 1m ago

 John



 Master

■ RUNNING 1 / 1 VMs

 Slave

■ RUNNING 3 / 3 VMs



The users can perform basic administration on their account. They can check his current usage and quotas, or generate accounting reports.

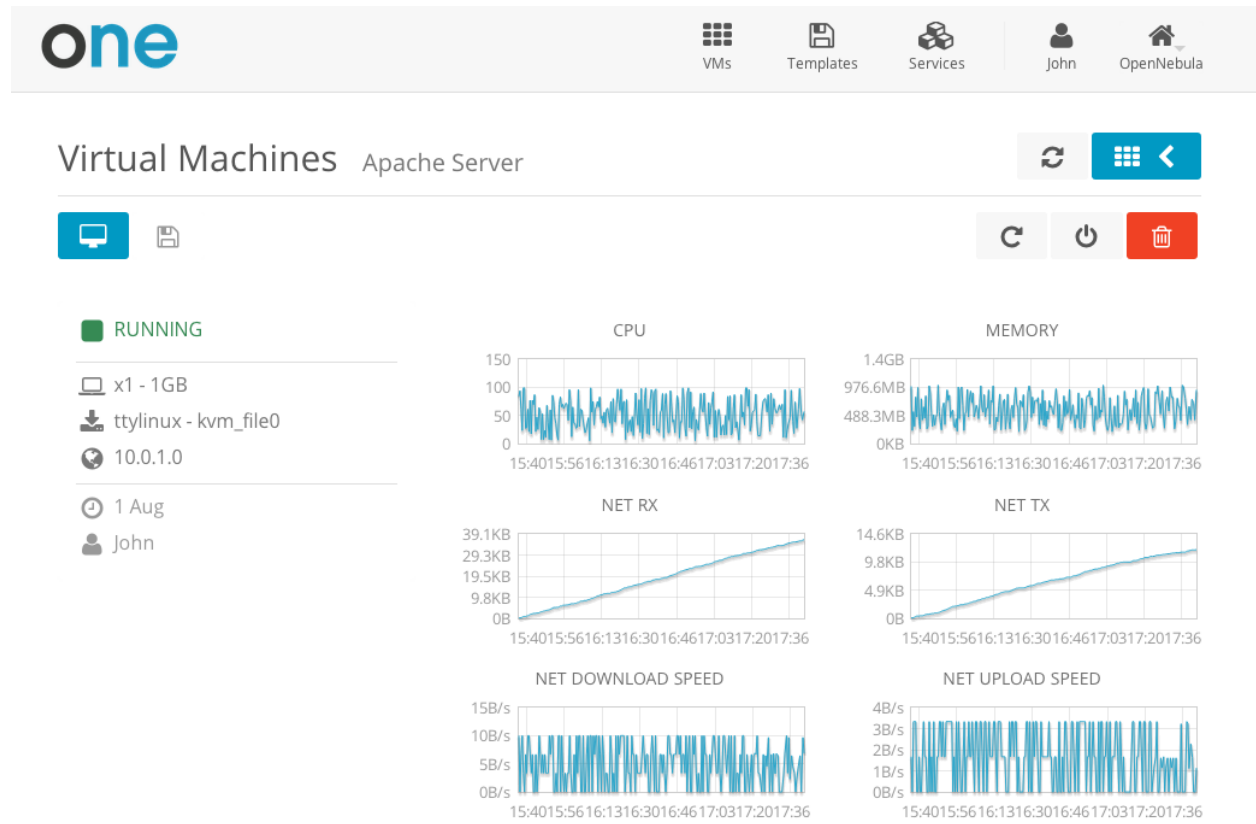

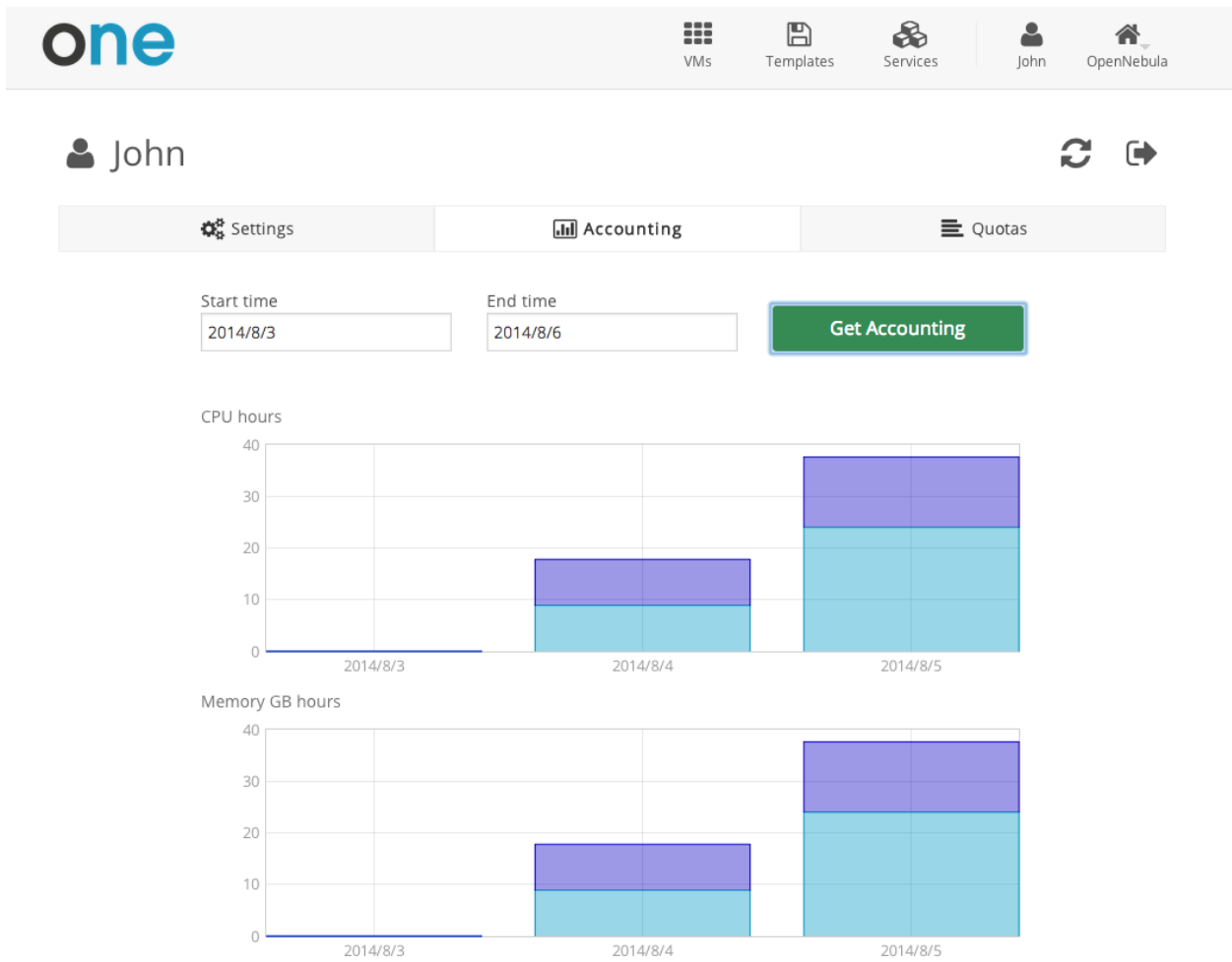
From the user settings tab, the users can also change their password, language, and ssh key.

